

Rhinologie
Rhinology
Rinología
Rhinologie
Rinología

37

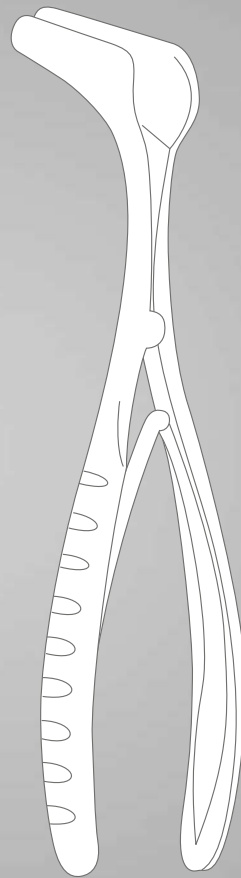
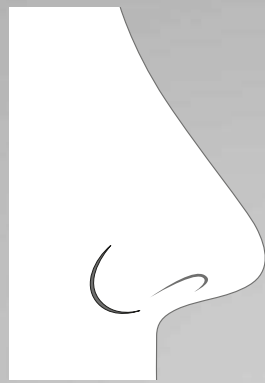

Nasentamponpinzetten, Nasentamponzangen

Nasal Tampon Forceps, Nasal Tampon Forceps

Pinzas para taponamiento, Pinzas para taponamiento

Pinces à pansements, Pinces à pansements

Pinze per medicature, Pinze per medicature

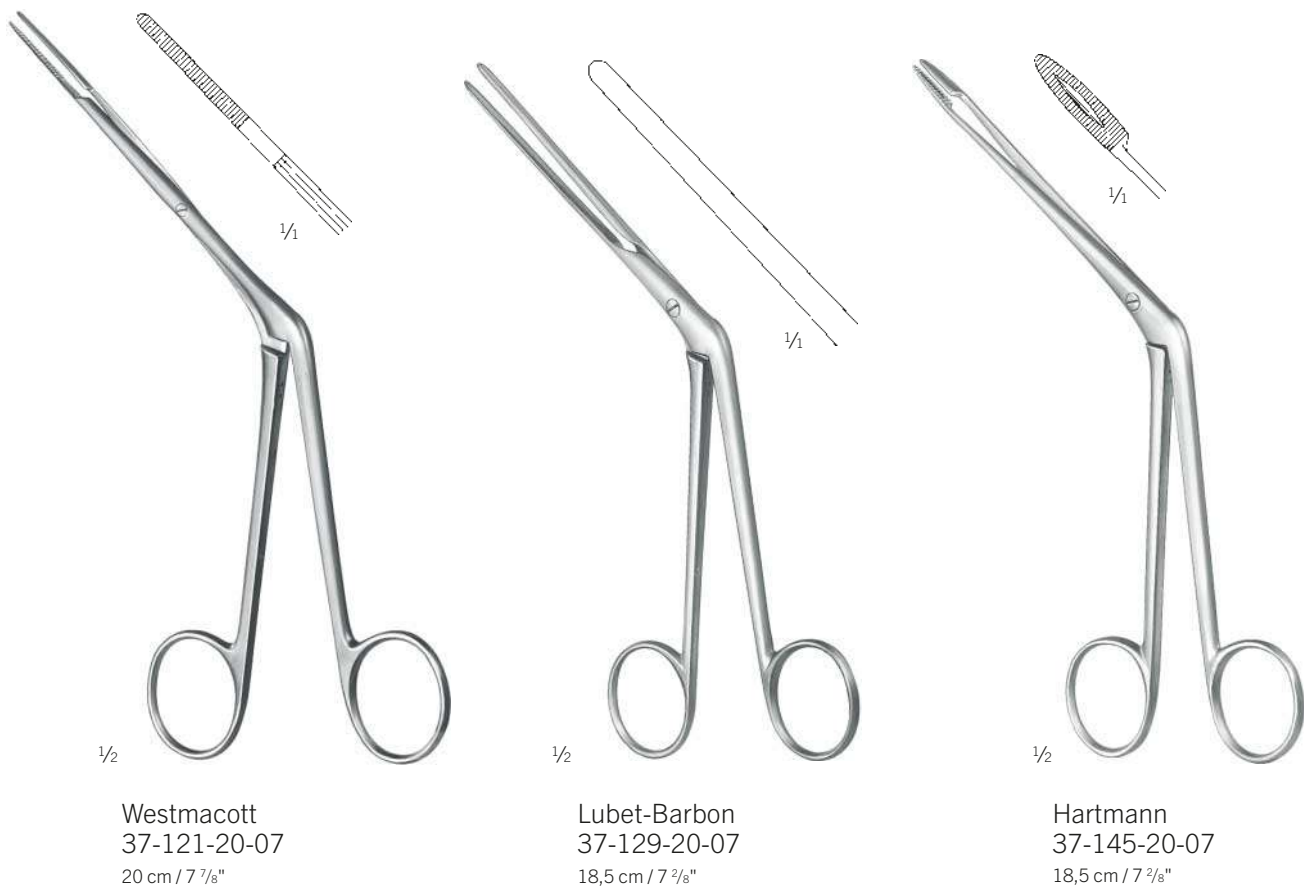
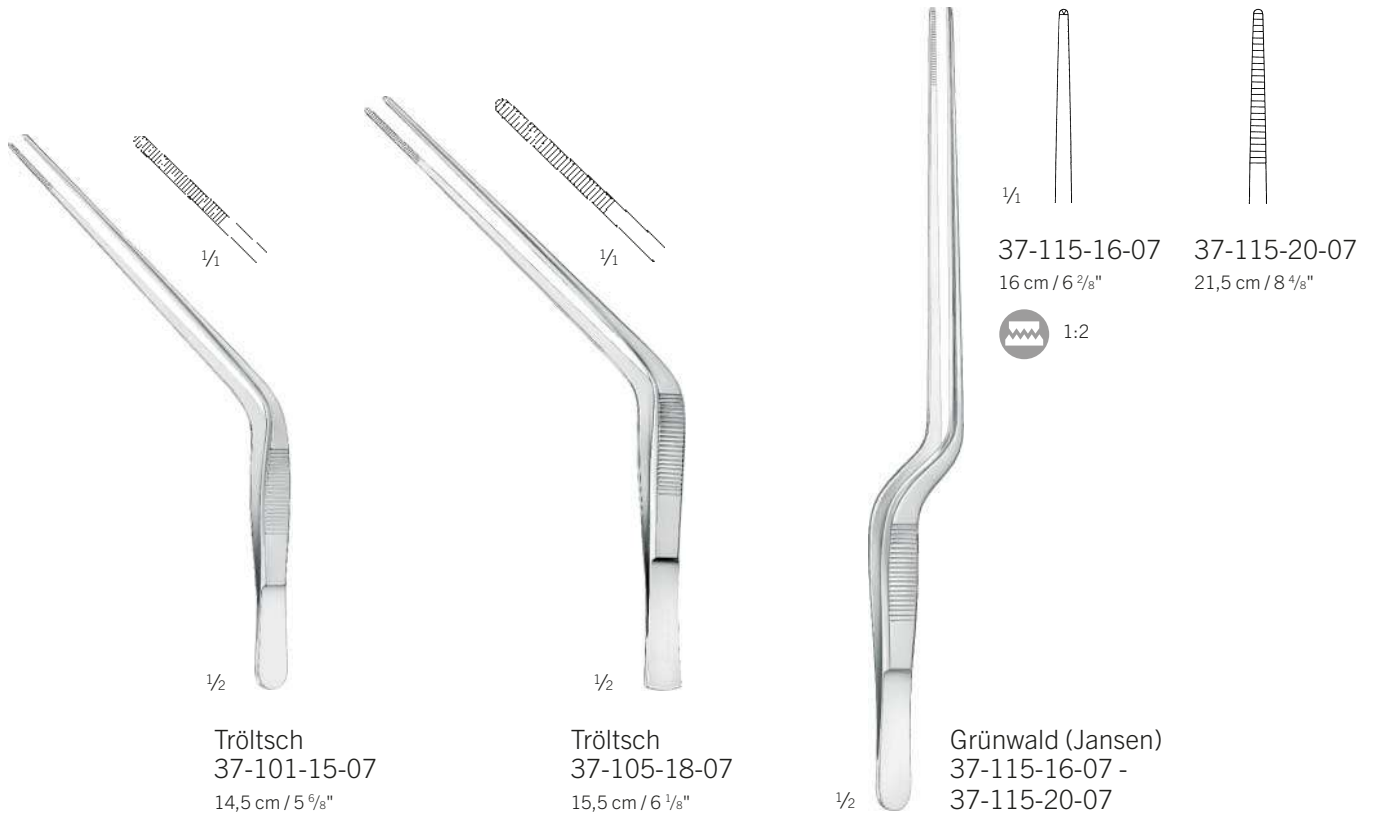

Nasenpolypenzange
Nasal Polypus Forceps
Pinza para pólipos nasales
Pince à polypes nasaux
Pinza per polipi nasali

Septumzangen

Septum Forceps
Pinzas para tabique nasal
Pinces pour la cloison nasale
Pinze per il setto nasale

Rhinologie

Rhinology
Rinología
Rhinologie
Rinologia

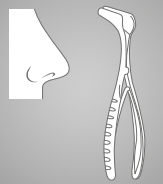

5 mm
Knight
37-207-18-07
17 cm / 6 5/8"

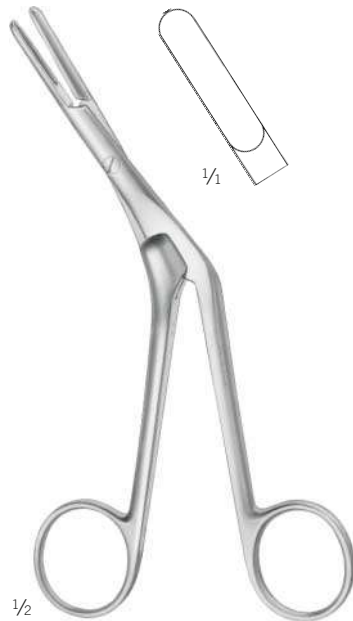

5,5 mm
Graig
37-213-18-07
16 cm / 6 2/8"



8,5 mm
37-215-01-07
links gebogen
left curved
curvo por izquierdo
courbé à gauche
curvo a sinistra

37-215-01-07
15,5 cm / 6 1/8"



Brünings
37-227-01-07 -
37-227-04-07
16,5 cm / 6 4/8"

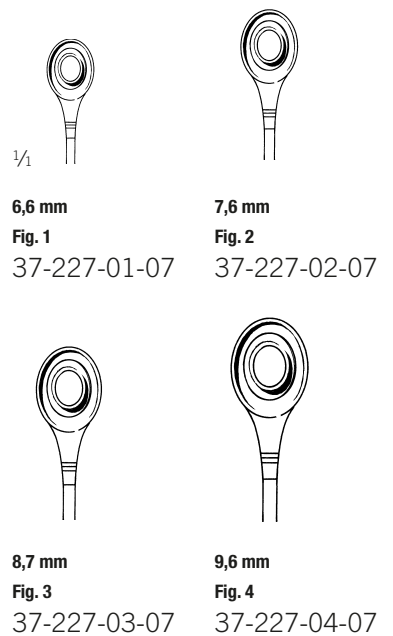

6,6 mm
Fig. 1
37-227-01-07

7,6 mm
Fig. 2
37-227-02-07

8,7 mm
Fig. 3
37-227-03-07

9,6 mm
Fig. 4
37-227-04-07

Siebbeinzangen

Ethmoid Bone Forceps

Pinzas para etmoides

Pinces éthmoidales

Pinze etmoidali

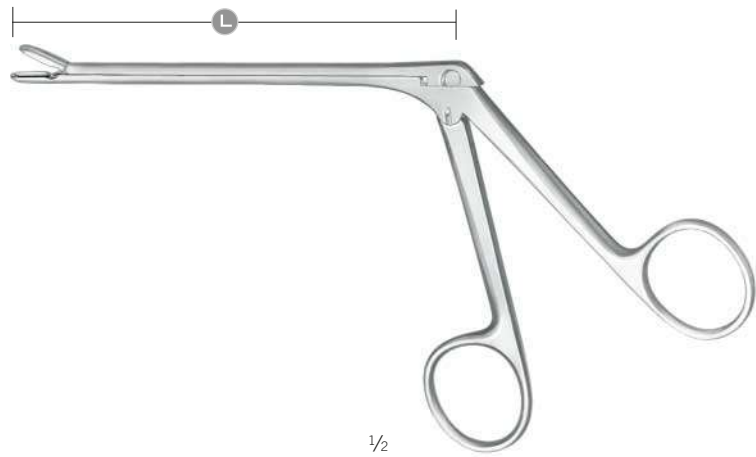

Takahashi
37-235-12-07 -
37-237-12-07

Maulbreite Jaw width Anchura de la boca Largeur de mors Larghezza della bocca		gerade straight recto droit diritto	45° aufgewinkelt angled upward acodado arrib angulé vers le haut angolato verso l'alto
		1/1	
	L	12 cm	12 cm
3,5 mm 		37-235-12-07	37-237-12-07



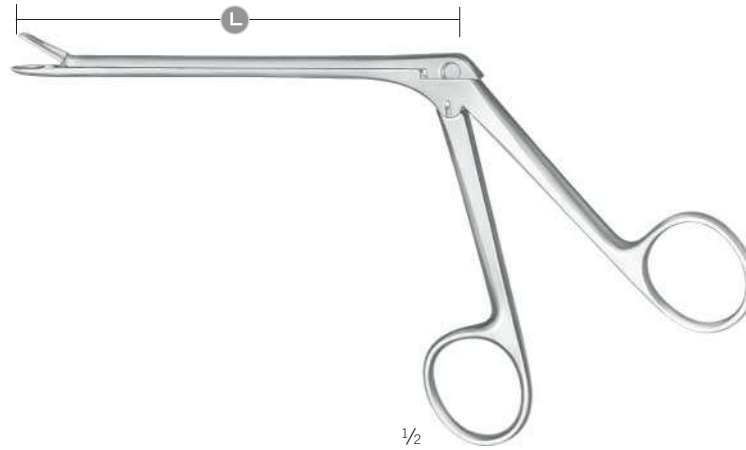
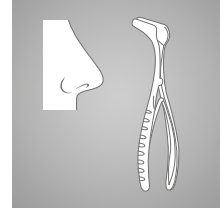

Siebbeinzangen
 Ethmoid Bone Forceps
 Pinzas para etmoides
 Pince étmoidales
 Pinze etmoidali

Rhinologie
 Rhinology
 Rinologia
 Rinologie
 Rinologia

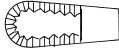

37

37-241-10-07 -
 37-249-12-07

Maul Jaw Boca Mors Bocca		gerade straight recto droit diritto	gerade straight recto droit diritto	gerade straight recto droit diritto
	1/1	 Watson-Williams		 Weil
	L	12 cm	12 cm	12 cm
	7,0 mm		37-241-10-07	
8,0 mm			37-241-12-07	
5,5 mm				37-249-12-07

Scharfe Nasenzangen, Siebbeinzangen

Nasal Cutting Forceps, Ethmoid Bone Forceps

Pinzas nasales cortantes, Pinzas para etmoides

Pinces nasales coupantes, Pinces étmoidales

Pinze taglianti per il naso, Pinze etmoidali

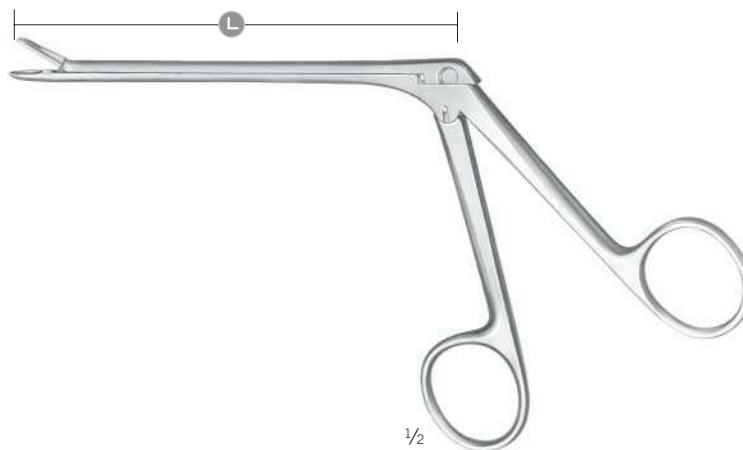

Weil-Blakesley
37-255-01-07 -
37-258-04-07

Maulbreite Jaw width Anchura de la boca Largeur de mors Larghezza della bocca		gerade straight recto droit diritto		45° aufgewinkelt angled upward acodado arrib angulé vers le haut angolato verso l'alto		90° aufgewinkelt angled upward acodado arrib angulé vers le haut angolato verso l'alto	
		$\frac{1}{1}$		$\frac{1}{1}$		$\frac{1}{1}$	
		L	12 cm	L	12 cm	L	12 cm
Fig. 1 3,0 mm			37-255-01-07		37-256-01-07		37-258-01-07
Fig. 2 3,5 mm			37-255-02-07		37-256-02-07		37-258-02-07
Fig. 3 4,5 mm			37-255-03-07		37-256-03-07		37-258-03-07
Fig. 4 5,0 mm			37-255-04-07		37-256-04-07		37-258-04-07
Fig. 5 6,0 mm			37-255-05-07				

Scharfe Nasenzange

Nasal Cutting Forceps
 Pinzas nasales cortantes
 Pincas nasales coupantes
 Pinze taglienti per il naso

Rhinologie

Rhinology
 Rinología
 Rinologie
 Rinologia

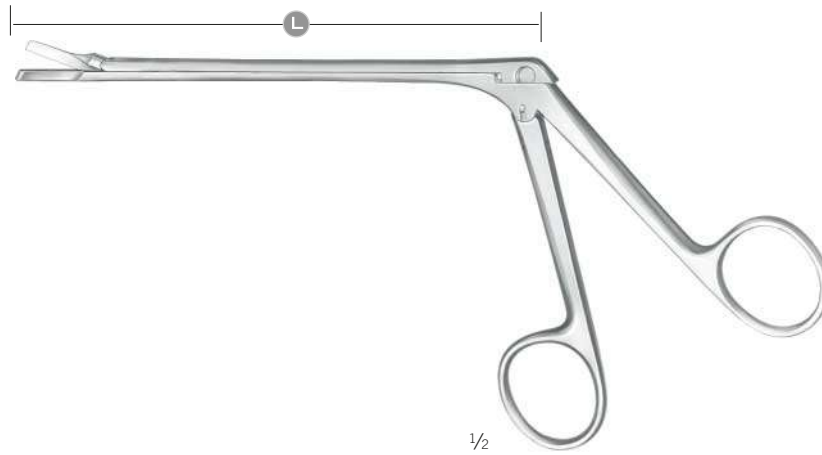
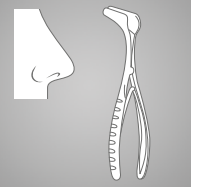

Struycken
 37-285-01-07

37

<p>Maulbreite Jaw width Anchura de la boca Largeur de mors Larghezza della bocca</p>	<p>gerade straight recto droit diritto</p>
<p>1/1</p>	
<p>L</p>	<p>12 cm</p>
<p>Fig. 1 1,0 mm</p>	<p>37-285-01-07</p>

Antrumstanzen

Antrum Punches

Pinzas sacabocadas para seno maxilar

Pinces emporte-pièces pour sinus maxillaire

Pinze taglienti per seno mascellare

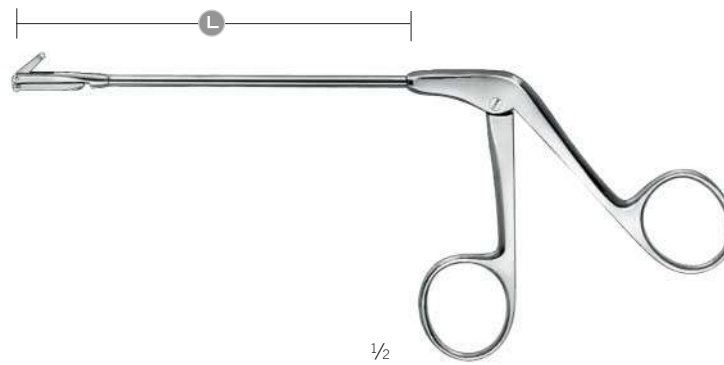

37-308-01-07 -
37-308-03-07

Maulbreite Jaw width Anchura de la boca Largeur de mors Larghezza della bocca	$\frac{1}{2}$	retrograd aufwärts schneidend retrograde, up cutting retrógrado, cortante en la parte superior retrograde, coupant en haut retrogrado, taglio in sù	retrograd rechts schneidend retrograde, right cutting retrógrado, cortante a la derecha retrograde, coupant à droit retrogrado, taglio destro	retrograd links schneidend retrograde, left cutting retrógrado, cortante a la izquierda retrograde, coupant à gauche retrogrado, taglio sinistro
2,5 mm		L 10 cm	10 cm	10 cm
		37-308-01-07	37-308-02-07	37-308-03-07

Scharfe Nasenzangen

Nasal Cutting Forceps
 Pinzas nasales cortantes
 Pincas nasales coupantes
 Pinze taglianti per il naso



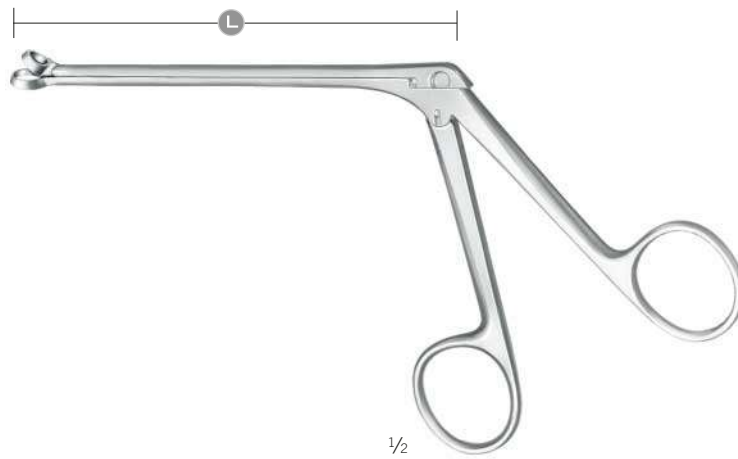
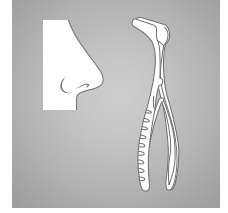

Rhinologie

Rhinology
 Rinología
 Rhinologie
 Rinologia



Hartmann
 37-309-01-07 -
 37-309-04-07

37

Maulbreite Jaw width Anchura de la boca Largeur de mors Larghezza della bocca	$\frac{1}{1}$	 Hartmann
		L 12 cm
Fig. 1 Ø 5,0 mm		37-309-01-07
Fig. 2 Ø 7,0 mm		37-309-02-07
Fig. 3 Ø 9,0 mm		37-309-03-07
Fig. 4 Ø 11,0 mm		37-309-04-07

Septumzangen, Septumquetschzange

Septum Forceps, Septum Morselizer

Pinzas para tabique nasal, Pinza para aplastamiento

Pinces pour la cloison nasale, Pince-gouge pour la cloison nasale

Pinze per il setto nasale, Pinza contundente per il setto nasale



1/4

durchschneidend
through-cutting
cortante
tranchante
tagliante

1/2

Middleton-Jansen
37-323-19-07
20,5 cm / 8 1/8"



1/4

1/2

Middleton-Jansen
37-327-19-07
20 cm / 7 7/8"

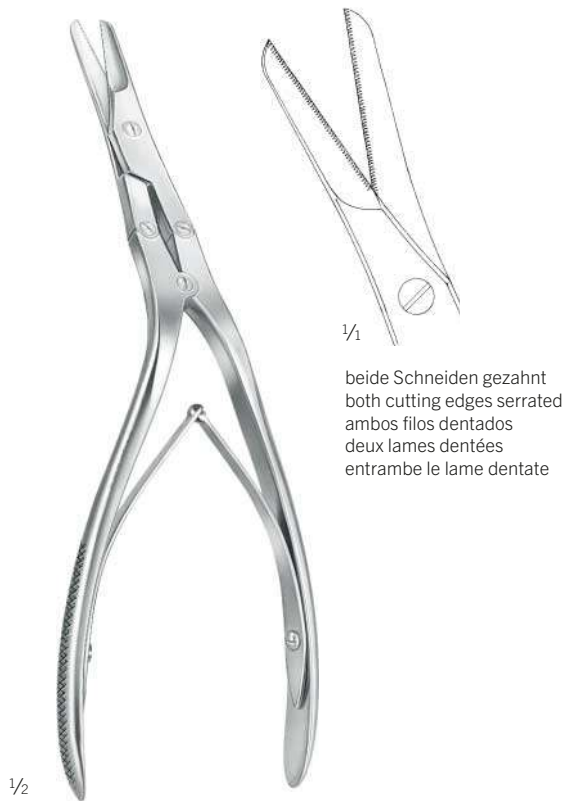

1/4

beide Schneiden gezahnt
both cutting edges serrated
ambos filos dentados
deux lames dentées
entrambe le lame dentate

1/2

Caplan
37-331-20-07
20 cm / 7 7/8"

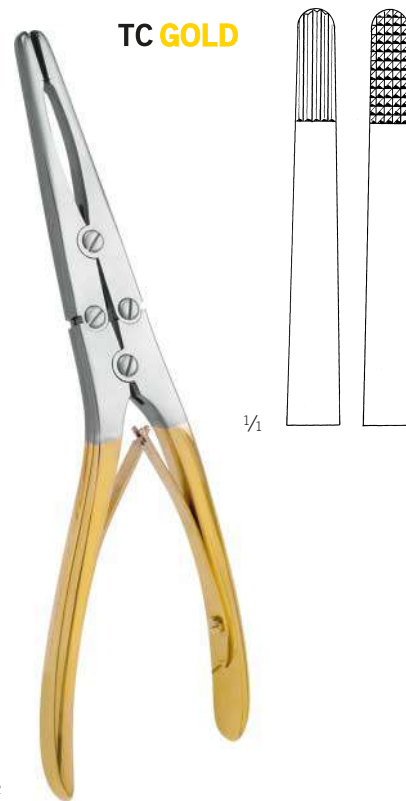

TC GOLD

1/4

1/2

37-334-21-07
20 cm / 7 7/8"

Septumquetschzangen

Septum Morselizers

Pinzas para aplastamiento

Pinces-gouge pour la cloison nasale

Pinze contundente per il setto nasale

Rhinologie

Rhinology

Rinología

Rhinologie

Rinologia

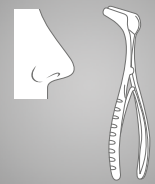

TC GOLD



Rubin
37-335-20-07
20 cm / 7 7/8"



Rubin
37-335-21-07
18,5 cm / 7 2/8"

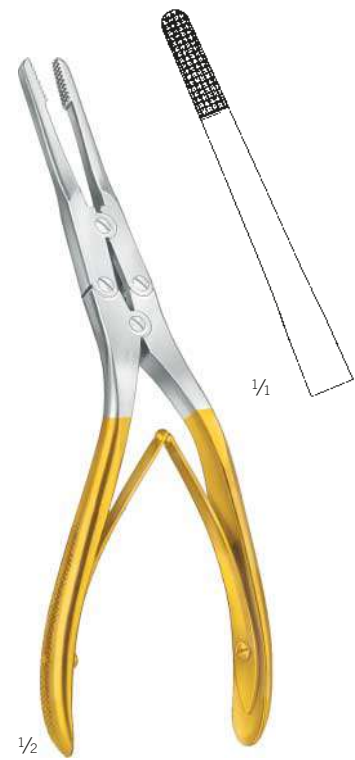

Rubin
37-337-21-07
18,5 cm / 7 2/8"



Rubin
37-335-01-07
Schutzkappe
Protection Cap
Caperuza protectora
Capuchon protecteur
Calotta protettiva



37-335-21-07

Keilbeinstanzen

Sphenoid Bone Punches

Pinzas sacabocadas para esfenoides

Pinces emporte-pièces pour sinus sphénoïdal

Pinze taglienti per seno sfenoidale

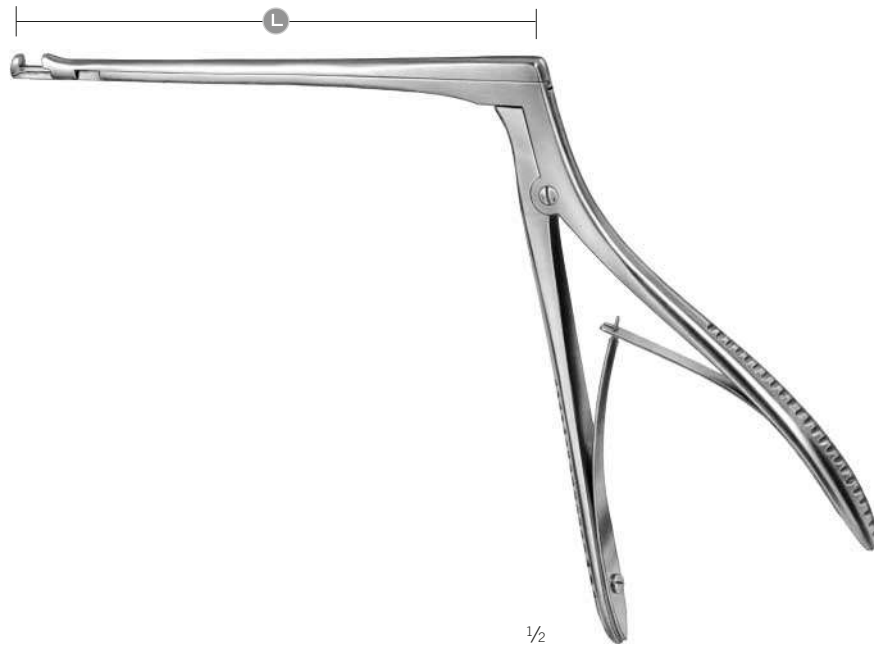

Hajek
37-340-13-07 -
37-343-12-07

Maulbreite Jaw width Anchura de la boca Largeur de mors Larghezza della bocca		90° aufwärts schneidend cutting upward corte arriba tranchant vers le haut tagliente verso l'alto	90° abwärts schneidend cutting downward desmontable, corte abajo tranchant vers le bas tagliente verso il basso
	1/1		
	L	14 cm	14 cm
3,5 mm		37-342-12-07	37-343-12-07
4 mm		37-340-13-07	37-341-13-07

Keilbeinstanzen

Sphenoid Bone Punches

Pinzas sacabocadas para esfenoides

Pinces emporte-pièces pour sinus sphénoïdal

Pinze taglianti per seno sfenoidale

Rhinologie

Rhinology

Rinología

Rhinologie

Rinologia

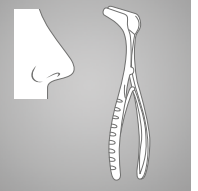

Ferris-Smith-Kerrison

37-356-17-07 -

37-362-05-07

37

Maulbreite Jaw width Anchura de la boca Largeur de mors Larghezza della bocca		90° aufwärts schneidend cutting upward corte arriba tranchant vers le haut tagliante verso l'alto	90° abwärts schneidend cutting downward desmontable, corte abajo tranchant vers le bas tagliante verso il basso	40° abwärts schneidend cutting downward desmontable, corte abajo tranchant vers le bas tagliante verso il basso
	1/1			
	L	18 cm	18 cm	18 cm
3 mm		37-356-17-07	37-357-17-07	37-362-03-07
5 mm		37-360-17-07	37-361-17-07	37-362-05-07

Antrumstanzen

Antrum Punches

Pinzas sacabocadas para seno maxilar

Pinces emporte-pièces pour sinus maxillaire

Pinze taglianti per seno mascellare



Kerrison
37-389-00-07 -
37-389-03-07

Maulbreite Jaw width Anchura de la boca Largeur de mors Larghezza della bocca	90° aufwärts schneidend cutting upward corte arriba tranchant vers le haut tagliante verso l'alto
3 x 3 mm	 L 9 cm
4 x 4 mm	37-389-00-07
5 x 5 mm	37-389-01-07
6 x 6 mm	37-389-02-07
	37-389-03-07

Rhinoplastik-Messer

Rhinoplastic Knives
Cuchillos rinoplásticos
Couteaux pour plastie du nez
Bisturi per plastica nasale

Rhinologie

Rhinology
Rinología
Rhinologie
Rinologia

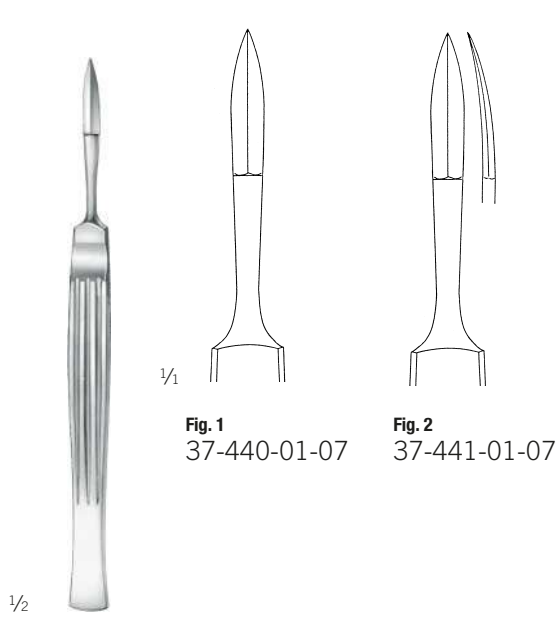
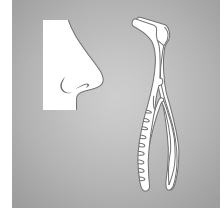
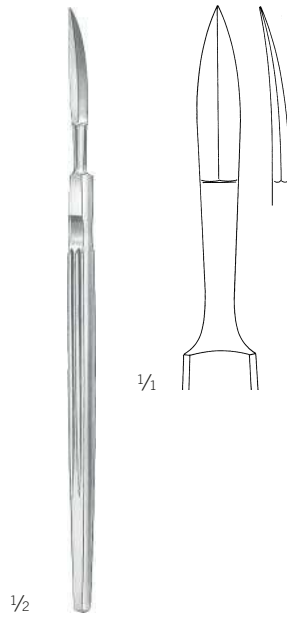
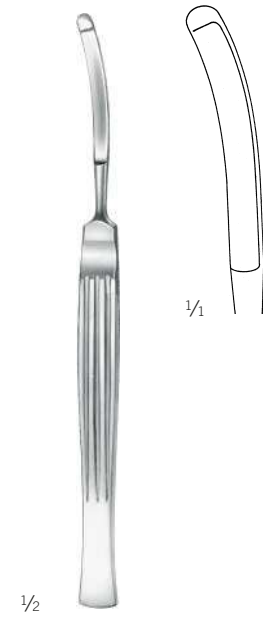

Fig. 1
37-440-01-07

Fig. 2
37-441-01-07



Fomon
37-444-16-07
16,5 cm / 6 4/8"



Converse
37-459-16-07
16 cm / 6 2/8"

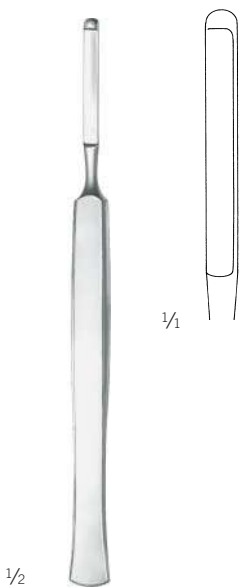

Joseph
37-466-15-07
15,5 cm / 6 1/8"

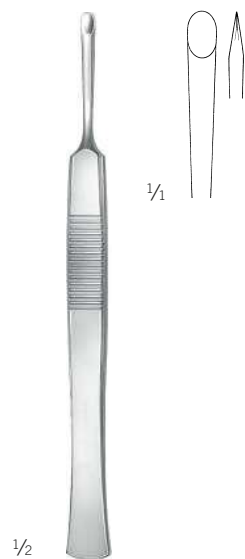

Cottle
37-468-15-07
14 cm / 5 4/8"

Septummesser, Schwingmesser

Septum Knives, Swivel Knives

Cuchillos para tabique nasal

Bistouris pour la cloison nasale

Bisturi per il setto nasale



Freer
37-484-15-07

15,5 cm / 6 1/8"

Mukosamesser
Mucosa Knife
Cuchillo para mucosa
Couteau pour muqueuse
Bisturi per mucosa

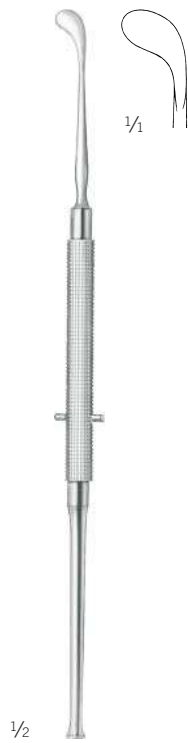

Freer
37-497-19-07

19 cm / 7 4/8"



Freer
37-499-19-07

18,5 cm / 7 3/8"

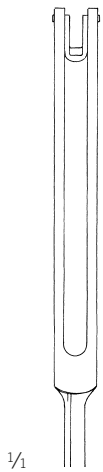

3 mm
37-504-03-07

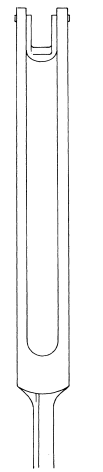

4 mm
37-504-04-07

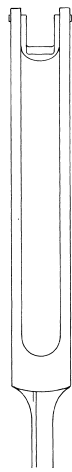

5 mm
37-504-05-07

Ballenger
37-504-03-07 -
37-504-05-07
21 cm / 8 2/8"

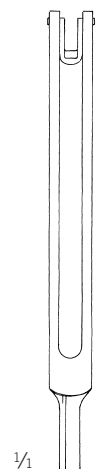

3 mm
37-505-03-07

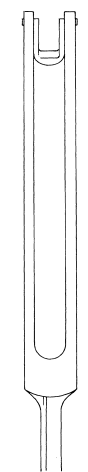

4 mm
37-505-04-07

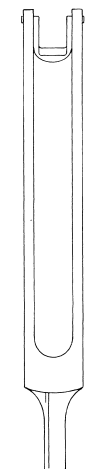

5 mm
37-505-05-07

Ballenger
37-505-03-07 -
37-505-05-07
20,5 cm / 8 1/8"

Septumelevatorien

Septum Elevators

Elevadores para tabique nasal

Élévateurs pour la cloison nasale

Elevatori per il setto nasale

Rhinologie

Rhinology

Rinología

Rhinologie

Rinologia

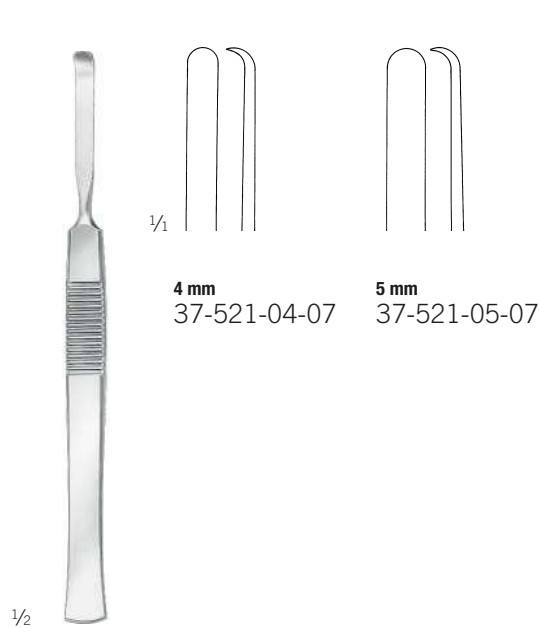
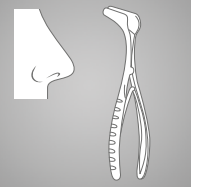

McKenty
37-521-04-07 -
37-521-05-07
15 cm / 5 7/8"

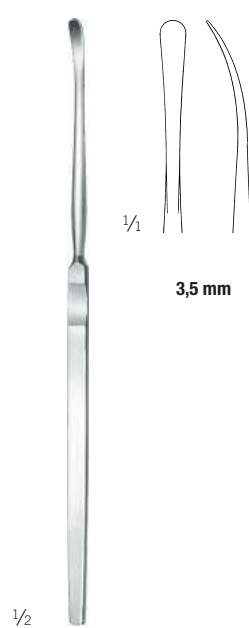

Halle
37-525-16-07
16 cm / 6 1/8"

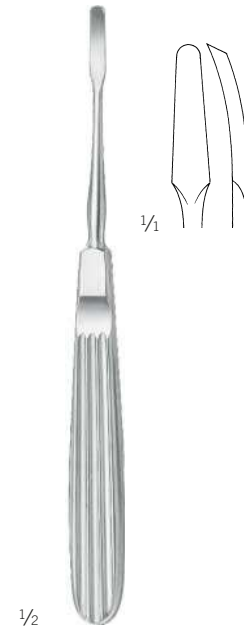

Joseph
37-531-16-07
16,5 cm / 6 1/2"

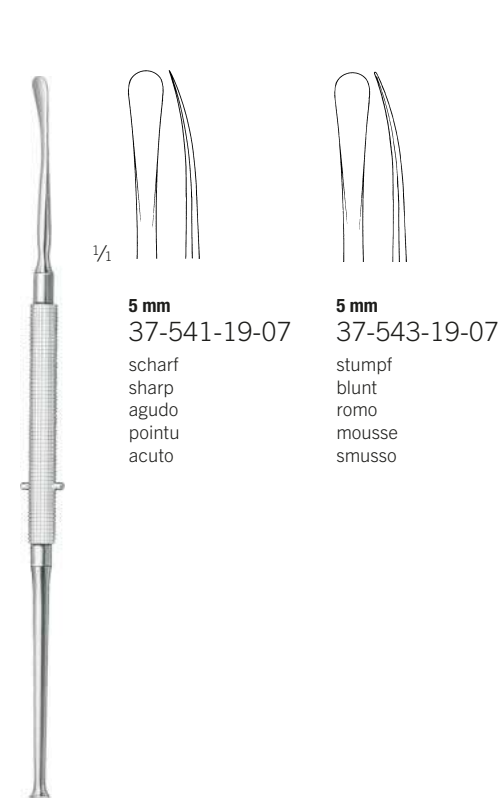

Freer
37-541-19-07 -
37-543-19-07
19 cm / 7 1/2"



Krenkel
37-544-01-07 -
37-544-02-07
Gaumenraspatorium
Cleft Palate Periosteal Raspatory
Legra para el paladar
Raspatoir pour palais
Raspatore per palato

Septumelevatorien

Septum Elevators

Elevadores para tabique nasal

Élévateurs pour la cloison nasale

Elevatori per il setto nasale

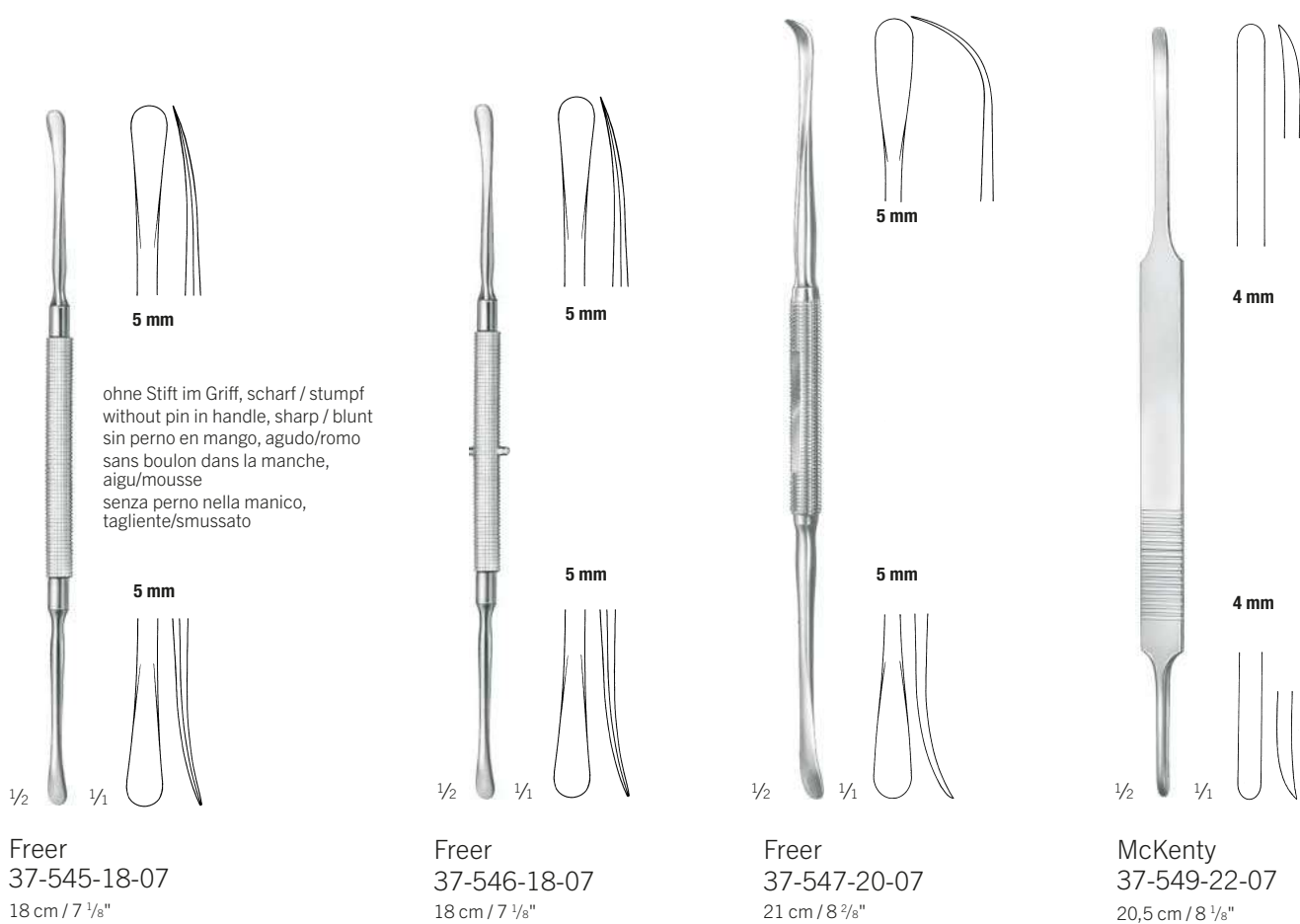

Septumlevatorien

Septum Elevators

Elevadores para tabique nasal

Elévateurs pour la cloison nasale

Elevatori per il setto nasale

Rhinologie

Rhinology

Rinología

Rhinologie

Rinologia

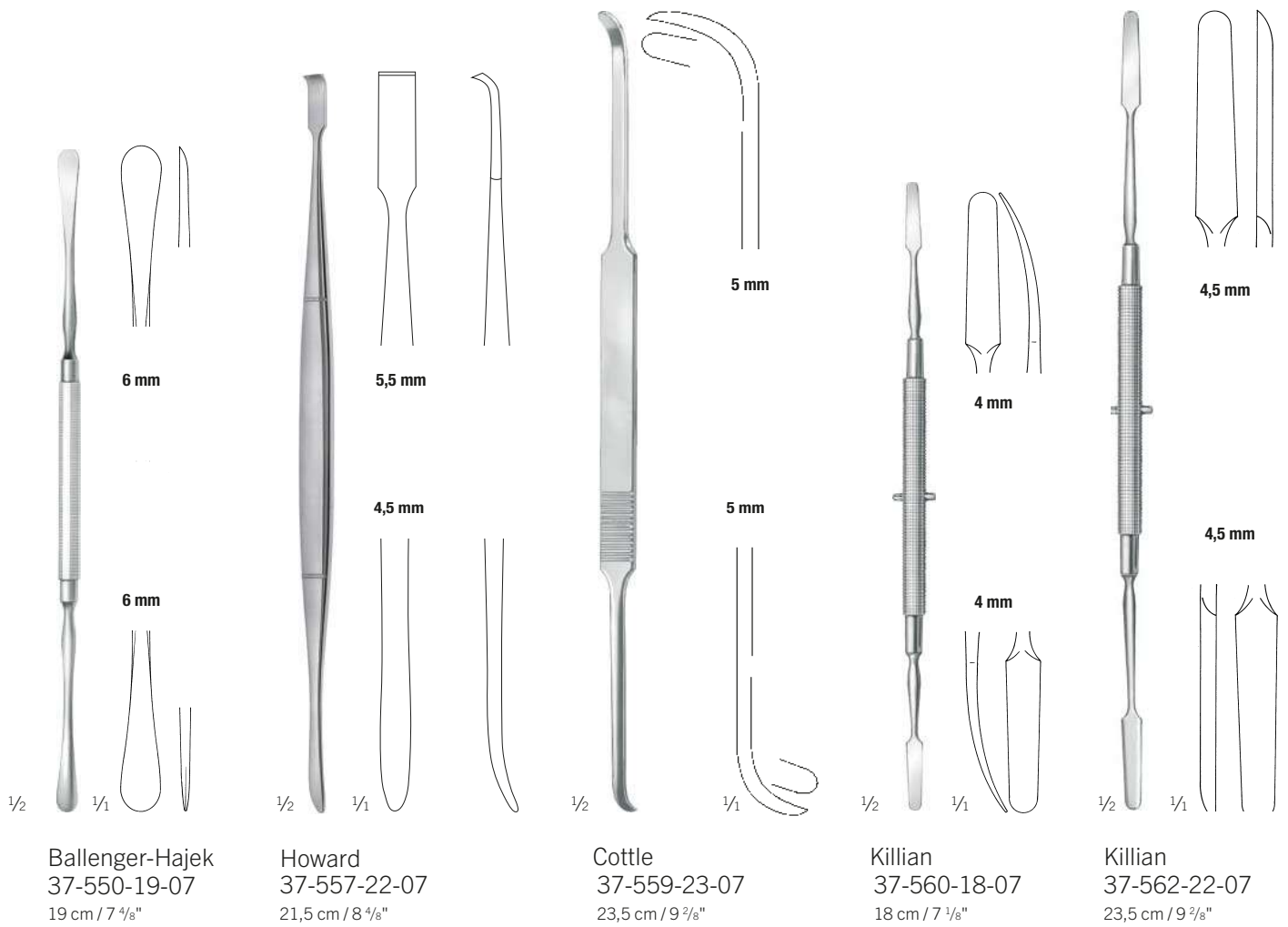
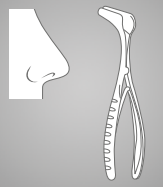

37

Periostelevatorien

Periosteal Elevators
 Legras para periostio
 Elévateurs pour le périoste
 Elevatori per il periostio

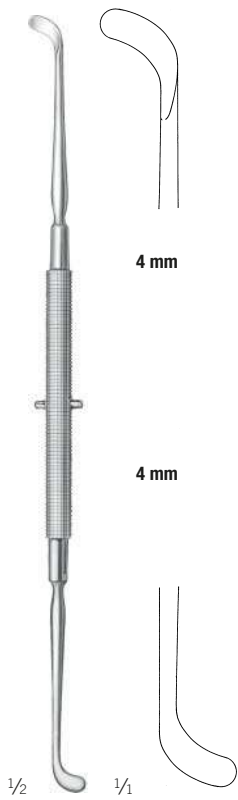

Pennington
 37-568-21-07
 21,5 cm / 8 4/8"

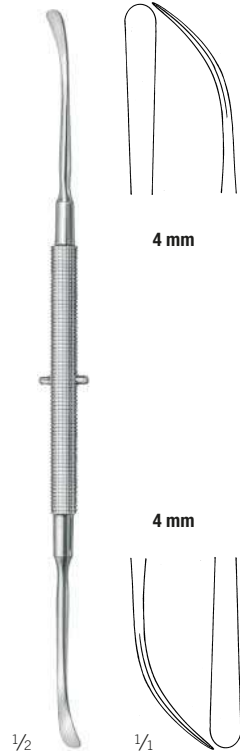

Roger
 37-572-19-07
 20 cm / 7 7/8"



Joseph-Masing
 37-579-22-07
 21,5 cm / 8 4/8"

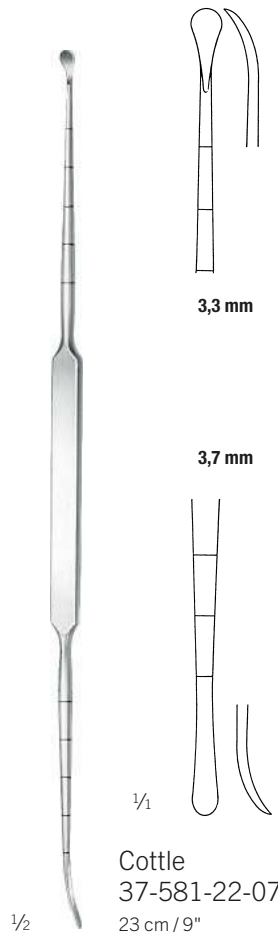

Cottle
 37-581-22-07
 23 cm / 9"

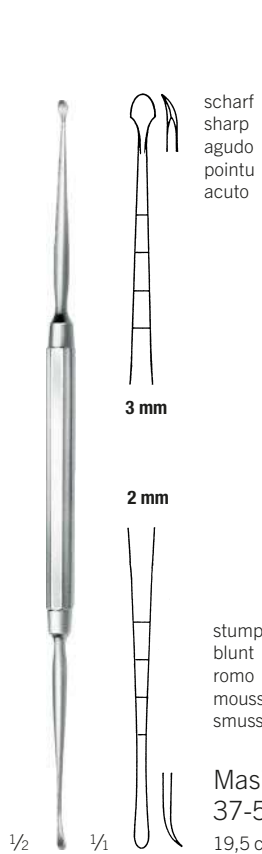

scharf
 sharp
 agudo
 pointu
 acuto

stumpf
 blunt
 romo
 mousse
 smusso

Masing
 37-583-21-07
 19,5 cm / 7 5/8"

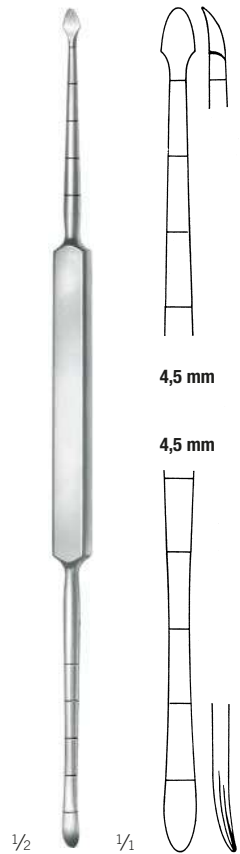

scharf
 sharp
 agudo
 pointu
 acuto

stumpf
 blunt
 romo
 mousse
 smusso

Cottle
 37-584-21-07
 22 cm / 8 5/8"

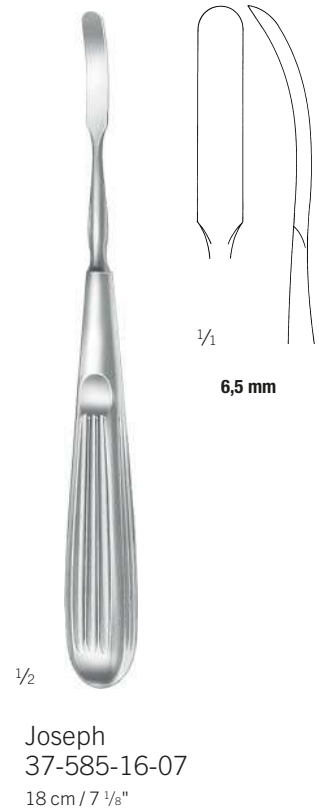

Joseph
 37-585-16-07
 18 cm / 7 1/8"

Septummeißel, Septum-Hohlmeißel

Septum Chisels, Septum Gouges

Cinceles para tabique nasal, Gubias para tabique nasal

Élévateurs pour le périoste, Gouges pour la cloison nasale

Elevatori per il periostio, Sgorbie per il setto nasale

Rhinologie

Rhinology

Rinología

Rhinologie

Rinologia

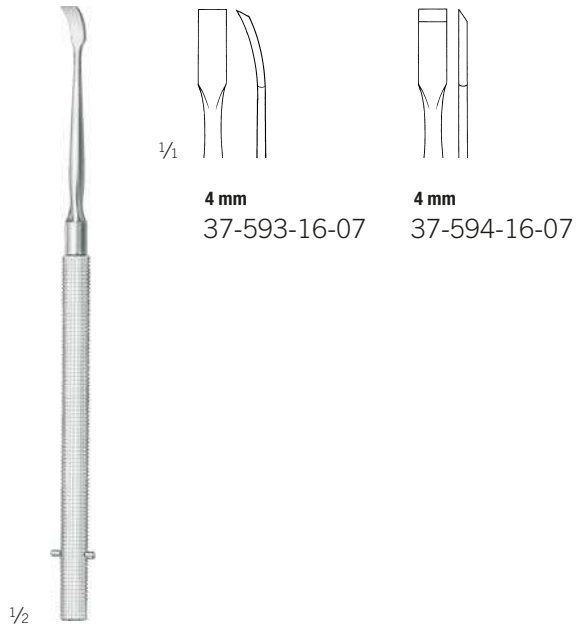
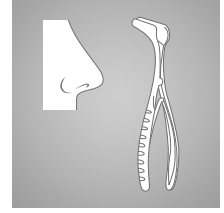

1/4

4 mm
37-593-16-07

4 mm
37-594-16-07

1/2

Freer
37-593-16-07 -
37-594-16-07
16,5 cm / 6 4/8"

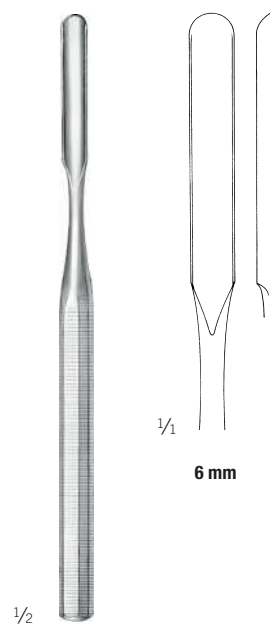

1/4

6 mm

1/2

Freer
37-595-15-07
16 cm / 6 2/8"

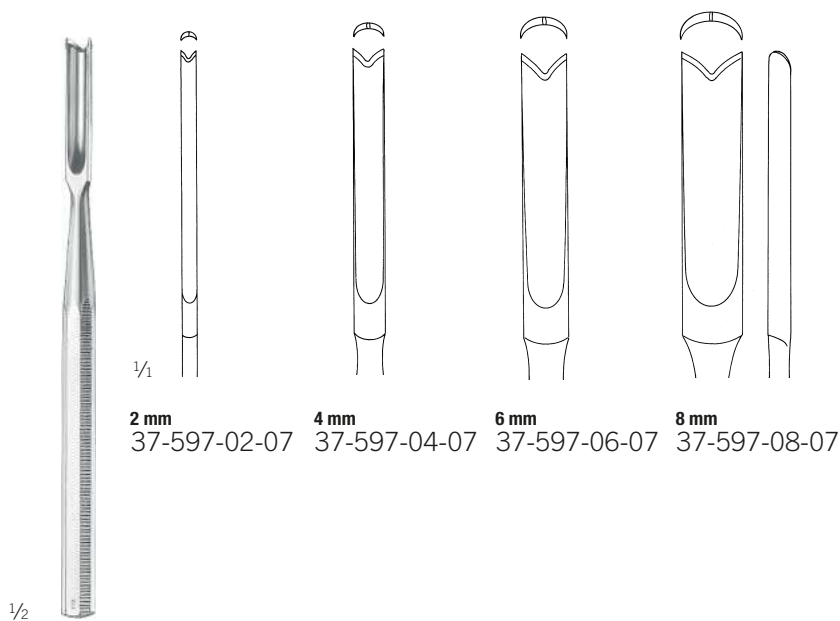

1/4

2 mm
37-597-02-07

4 mm
37-597-04-07

6 mm
37-597-06-07

8 mm
37-597-08-07

1/2

Ballenger
37-597-02-07 -
37-597-08-07
15 cm / 5 7/8"

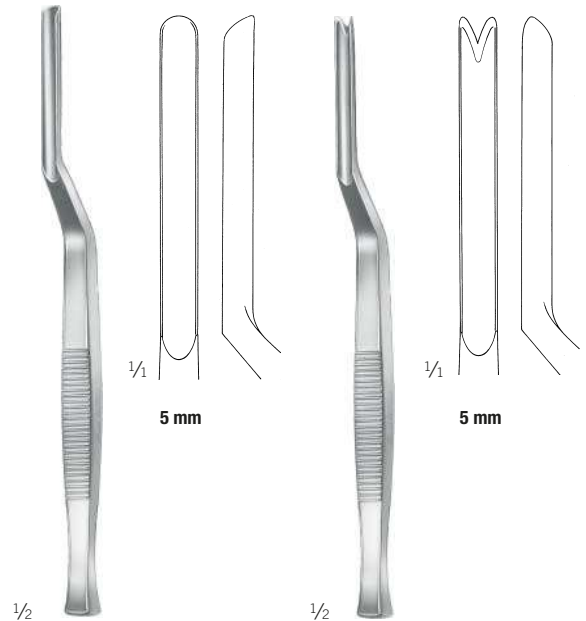

1/4

5 mm

1/4

5 mm

1/2

Killian
37-601-16-07
16 cm / 6 2/8"

1/2

Killian-Claus
37-605-16-07
16 cm / 6 2/8"

Osteotome

Osteotomes

Osteótomos

Ostéotomes

Osteotomi

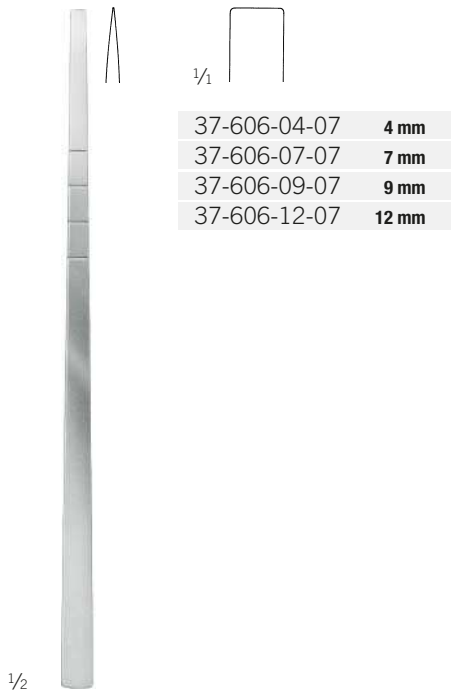

Cottle
37-606-04-07 -
37-606-12-07
18,5 cm / 7 2/8"



Cottle
37-607-06-07
18,5 cm / 7 2/8"

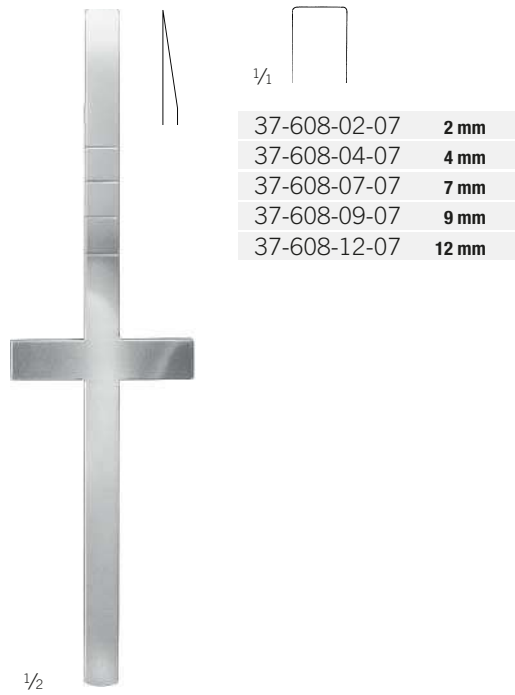

Cottle
37-608-02-07 -
37-608-12-07
18,5 cm / 7 2/8"



Cottle
37-609-06-07
18,5 cm / 7 2/8"

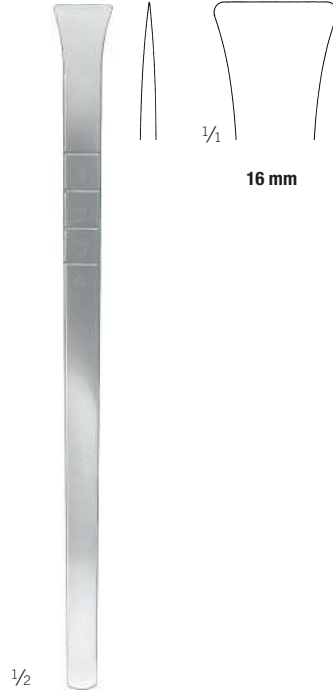

Cottle
37-610-16-07
18,5 cm / 7 2/8"

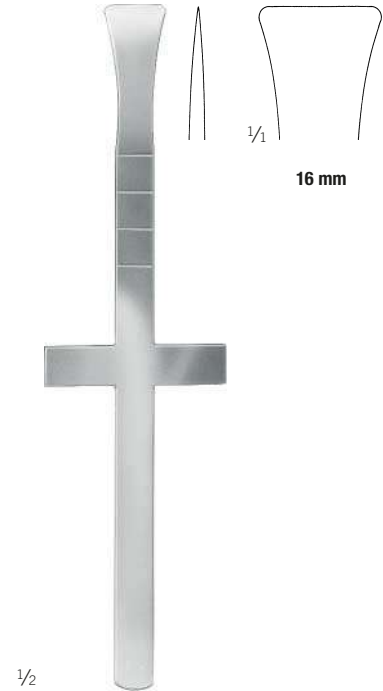

Cottle
37-612-16-07
18,5 cm / 7 2/8"

Osteotome, Meißel

Osteotomes, Chisels
 Osteótomos, Cinceles
 Ostéotomes, Ciseaux-burins
 Osteotomi, Scalpelli

Rhinologie

Rhinology
 Rinología
 Rinologie
 Rinologia

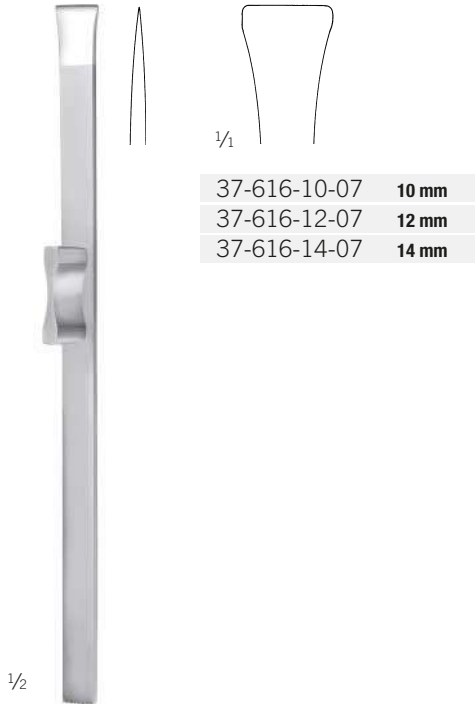
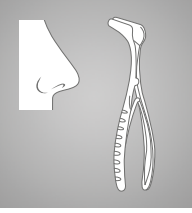

37-616-10-07	10 mm
37-616-12-07	12 mm
37-616-14-07	14 mm

Rubin
 37-616-10-07 -
 37-616-14-07
 18,5 cm / 7 7/8"

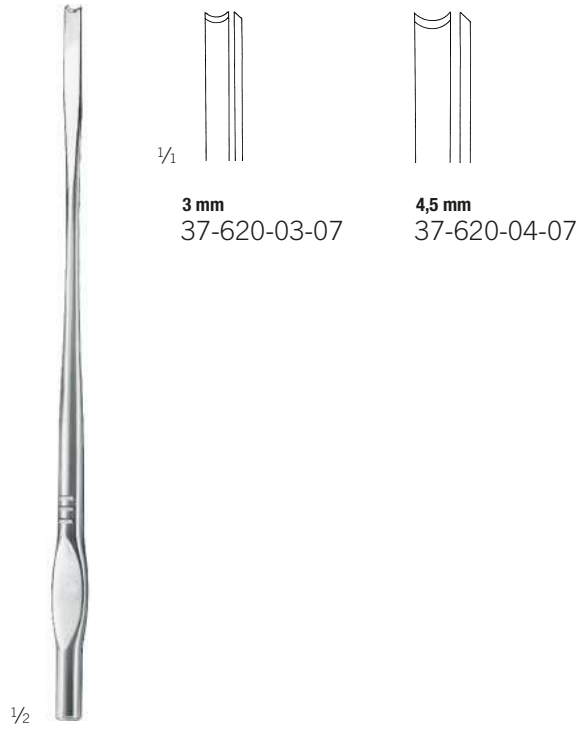

37-620-03-07	3 mm
37-620-04-07	4,5 mm

Walter
 37-620-03-07 -
 37-620-04-07
 19 cm / 7 7/8"

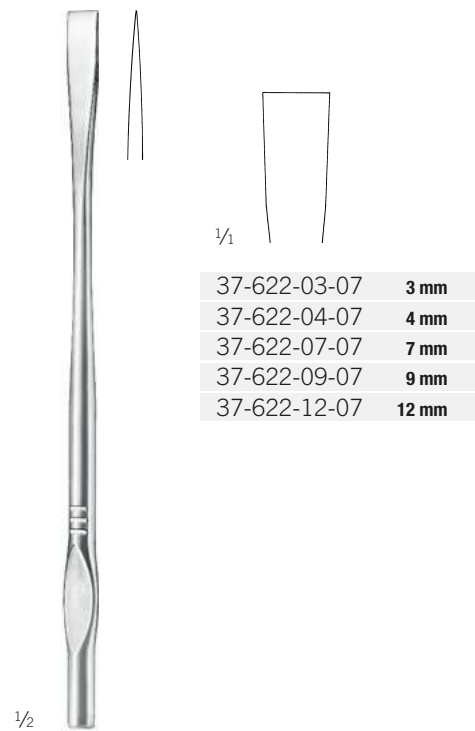

37-622-03-07	3 mm
37-622-04-07	4 mm
37-622-07-07	7 mm
37-622-09-07	9 mm
37-622-12-07	12 mm

Walter
 37-622-03-07 -
 37-622-12-07
 19 cm / 7 7/8"

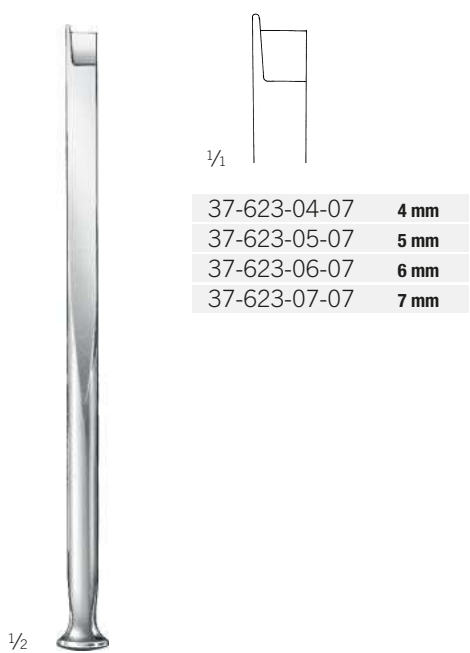

37-623-04-07	4 mm
37-623-05-07	5 mm
37-623-06-07	6 mm
37-623-07-07	7 mm

Fomon
 37-623-04-07 -
 37-623-07-07
 16 cm / 6 7/8"

Nasenmeißel, Meißel

Rhinoplastic Chisels, Chisels

Cinceles nasales, Cinceles

Ciseaux-burins nasaux, Ciseaux-burins

Scalpelli nasali, Scalpelli



1/2

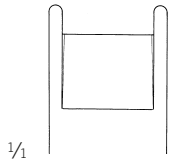

1/1

37-624-10-07	10 mm
37-624-12-07	12 mm
37-624-14-07	14 mm
37-624-16-07	16 mm

Cinelli
37-624-10-07 -
37-624-16-07
16 cm / 6 3/8"



1/2

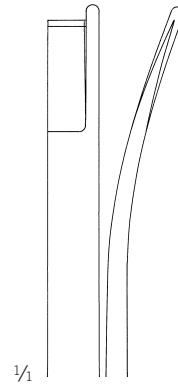

1/1

7 mm
37-625-01-07

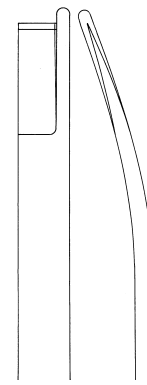

7 mm
37-625-02-07

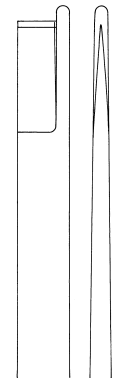

7 mm
37-625-03-07

Neivert-Anderson
37-625-01-07 -
37-625-03-07
20,5 cm / 8 1/8"



1/2

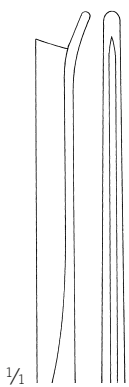

1/1

5 mm

Silver
37-628-01-07
18 cm / 7 1/8"



1/2

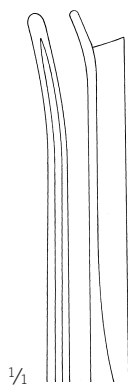

1/1

5 mm

Silver
37-628-02-07
18 cm / 7 1/8"



1/2

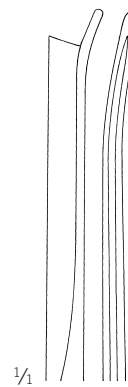

1/1

5 mm

Silver
37-628-03-07
18 cm / 7 1/8"

Nasensägen

Nasal Saws
Sierras nasales
Scies nasales
Seghe nasali

Rhinologie

Rhinology
Rinología
Rhinologie
Rinologia

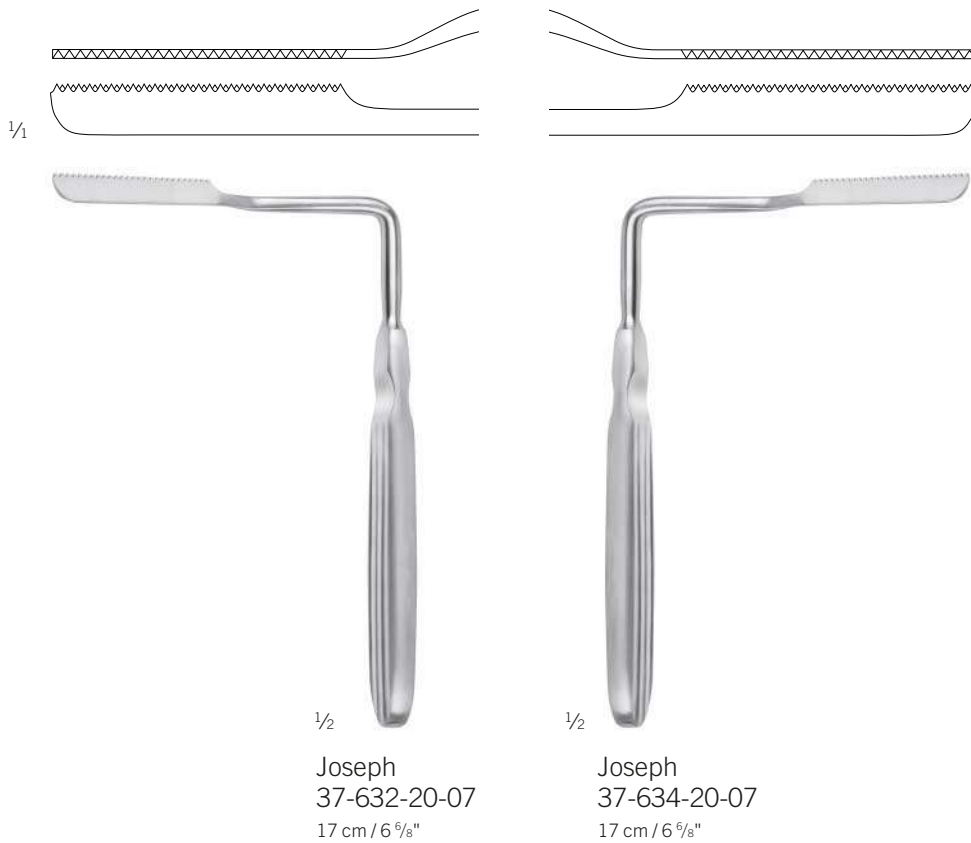
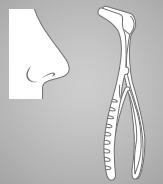

1/2

Joseph
37-632-20-07
17 cm / 6 5/8"

1/2

Joseph
37-634-20-07
17 cm / 6 5/8"

37

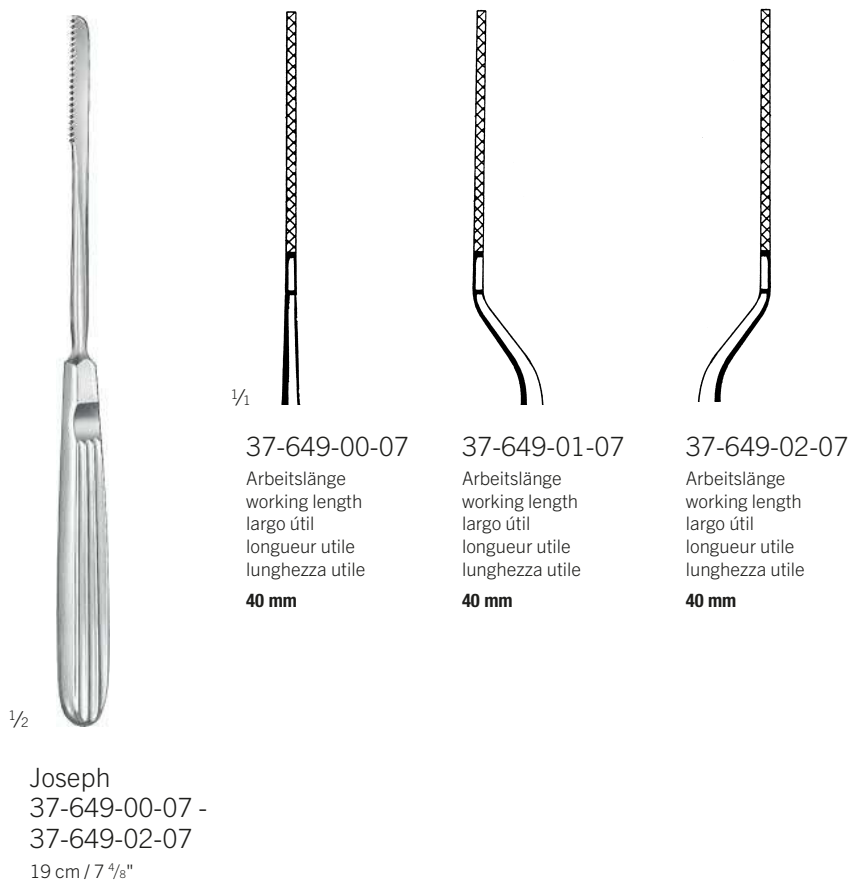

1/1

37-649-00-07
Arbeitslänge
working length
largo útil
longueur utile
lunghezza utile
40 mm

37-649-01-07
Arbeitslänge
working length
largo útil
longueur utile
lunghezza utile
40 mm

37-649-02-07
Arbeitslänge
working length
largo útil
longueur utile
lunghezza utile
40 mm

1/2

Joseph
37-649-00-07 -
37-649-02-07
19 cm / 7 4/8"

Knorpelquetsche

Cartilage Crusher

Machacadora

Pinces-gouge à cartilage

Torchio per cartilagine



Cottle
37-652-00-07

Knorpelquetsche
Cartilage Crusher
Machacadora
Pinces-gouge à cartilage
Torchio per cartilagine

65 x 30 x 30 mm

Nasenraspeln, Knochenfeilen, Antrumraspeln

Nasal Rasps, Bone Files, Antrum Rasps

Escofinas nasales, Limas para huesos, Escofinas para el antro

Râpes nasales, Limes à os, Râpes pour antre

Raspe nasali, Lime per ossa, Raspe per seno mascellare

Rhinologie

Rhinology

Rinología

Rhinologie

Rinologia

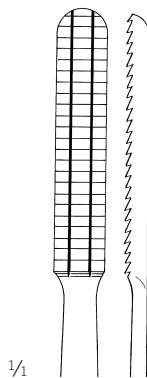
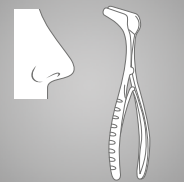

37-656-01-07

auf Zug schneidend
drawing cut
cortante a tracción
tranchante à traction
tagliente a trazione

34 x 7 mm

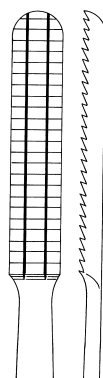

37-656-02-07

auf Stoss schneidend
pushing cut
cortante a empuje
tranchante à impact
tagliente a urto

34 x 7 mm

1/2

Maltz
37-656-01-07 -
37-656-02-07

17 cm / 6 5/8"

37

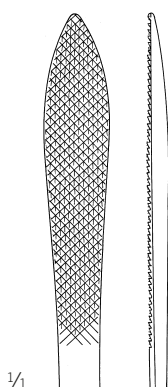

60 x 8 mm

1/2

Joseph
37-658-01-07

16 cm / 6 2/8"

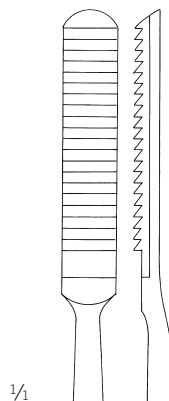

auf Zug schneidend
drawing cut
cortante a tracción
tranchante à traction
tagliente a trazione

34 x 8 mm

1/2

Cottle
37-670-21-07

21 cm / 8 2/8"

Glabellaraspeln, Nasenraspeln

Glabella Rasps, Nasal Rasps

Escofinas para glabella, Escofinas nasales

Râpes pour la glabelle, Râpes nasales

Raspe per glabella, Raspe nasali



1/1

32 x 9 mm

37-671-21-07

auf Stoss schneidend
pushing cut
cortante a empuje
tranchante à impact
tagliente a urto

1/2

Aufricht

37-671-21-07 -

37-673-21-07

21 cm / 8 3/8"

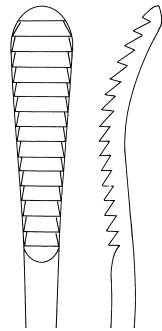
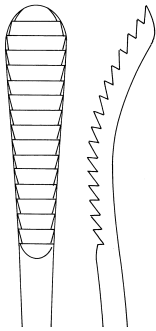

32 x 9 mm

37-673-21-07

auf Zug schneidend
drawing cut
cortante a tracción
tranchante à traction
tagliente a trazione

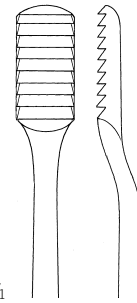

1/1

15 x 8 mm

37-674-18-07

auf Zug schneidend
drawing cut
cortante a tracción
tranchante à traction
tagliente a trazione

1/2

Lewis

37-674-18-07 -

37-676-18-07

19 cm / 7 1/8"

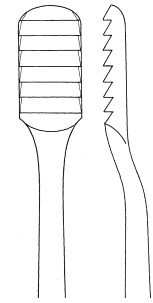

15 x 8 mm

37-676-18-07

auf Zug schneidend
drawing cut
cortante a tracción
tranchante à traction
tagliente a trazione

feine Zahnung
delicate serration
dentado fina
denture fine
dentatura delicata

grobe Zahnung
coarse serration
dentado grueso
denture grossière
dentatura grossolana



1/1



1/2

7 mm

Fomon

37-680-21-07

20,5 cm / 8 1/8"

Nasenraspeln

Nasal Rasps
Escofinas nasales
Râpes nasales
Raspe nasali

Rhinologie

Rhinology
Rinología
Rhinologie
Rinologia

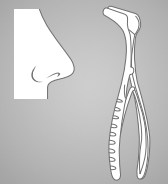

TC GOLD

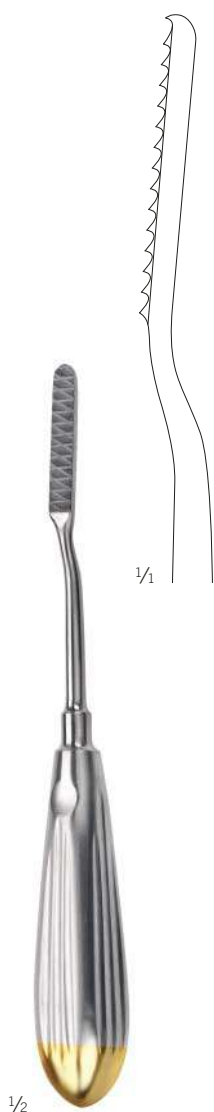

1/4

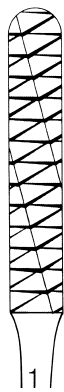

Fig. 1
37-680-01-07



Fig. 2
37-680-02-07



Fig. 3
37-680-03-07



Fig. 4
37-680-04-07



Fig. 5
37-680-05-07

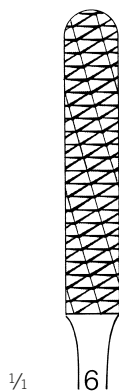

Fig. 6
37-680-06-07



Fig. 7
37-680-07-07



Fig. 8
37-680-08-07



Fig. 9
37-680-09-07



Fig. 10
37-680-10-07

7 mm
Maltz
37-680-01-07 -
37-680-10-07
21 cm / 8 2/8"

Nasenraspeln

Nasal Rasps

Escofinas nasales

Râpes nasales

Raspe nasali

TC GOLD

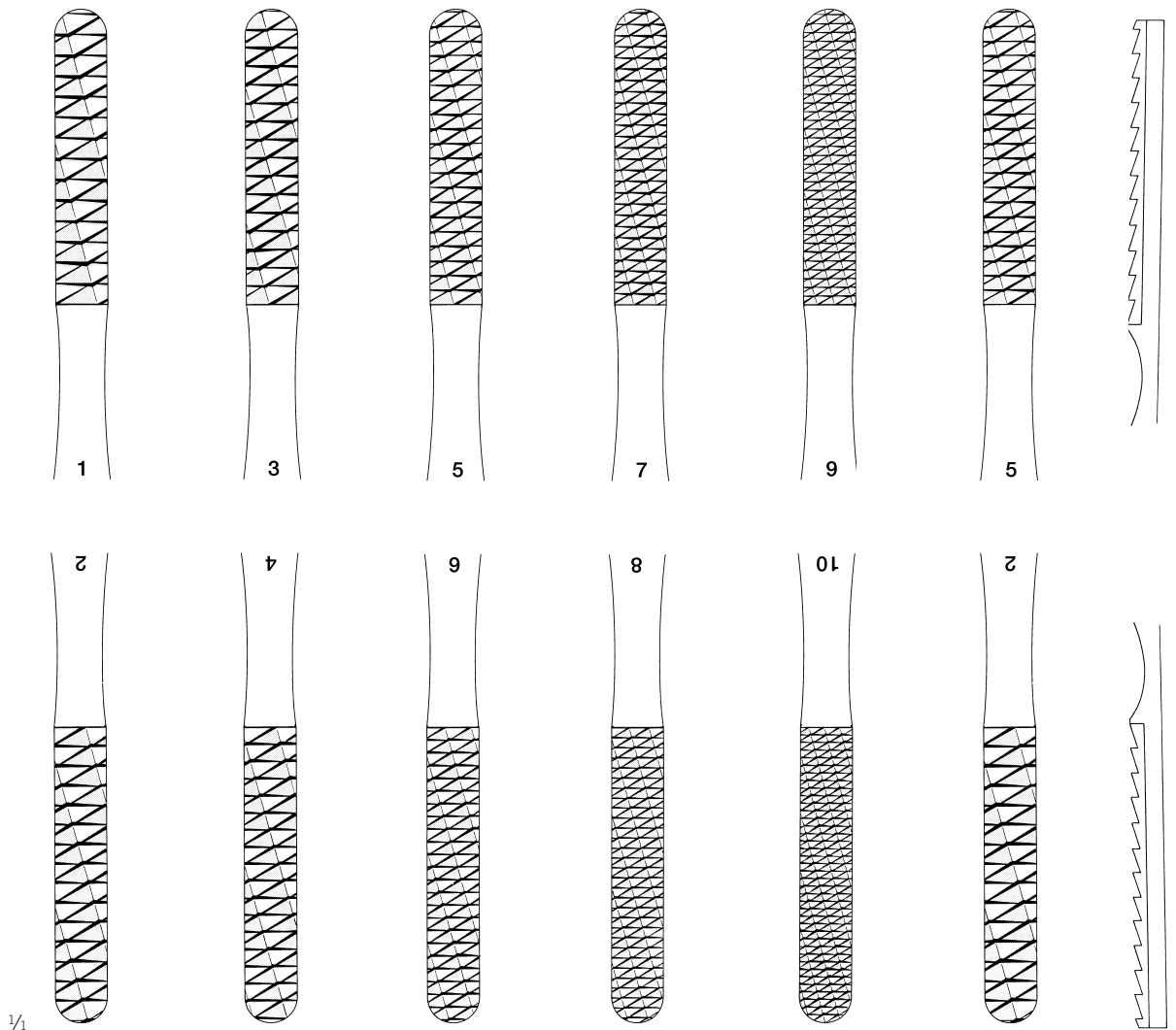

Fig. 1/2
37-682-01-07
40 x 7 mm

Fig. 3/4
37-682-02-07
40 x 7 mm

Fig. 5/6
37-682-03-07
40 x 7 mm

Fig. 7/8
37-682-04-07
40 x 7 mm

Fig. 9/10
37-682-05-07
40 x 7 mm

Fig. 2/5
37-682-06-07
40 x 7 mm

Fomon
37-682-01-07 -
37-682-06-07
20,5 cm / 8 1/8"

Nasenhäkchen

Nasal Hooklets
Ganchitos nasales
Crochets nasaux
Uncini nasali

Rhinologie

Rhinology
Rinología
Rhinologie
Rinologia

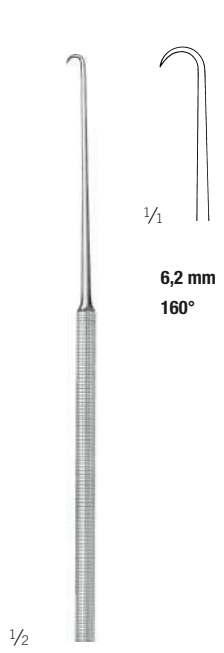
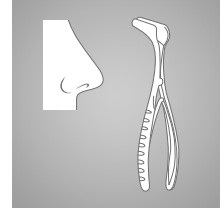

1/2
6,2 mm
160°

Joseph
37-684-15-07
15,5 cm / 6 1/8"
Schleimhauthäkchen, scharf
Mucosa Hooklet, sharp
Ganchito para mucosa, agudo
Crochet pour la muqueuse, pointu
Uncino per mucosa, acuto

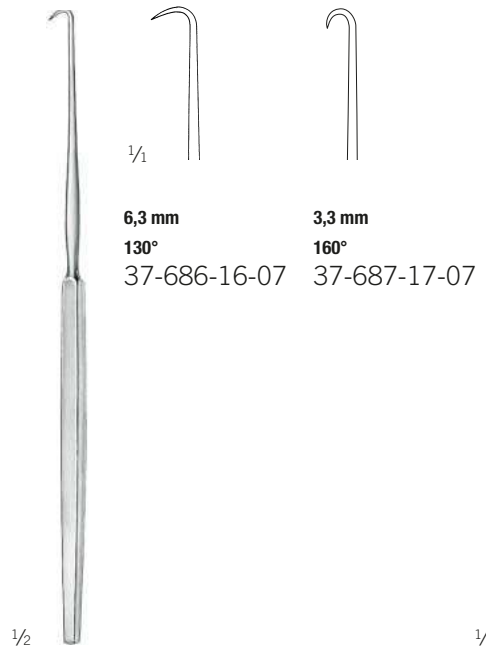

1/2
6,3 mm
130°
37-686-16-07
3,3 mm
160°
37-687-17-07

Cottle
37-686-16-07 - 37-687-17-07
17 cm / 6 1/8"
scharf
sharp
agudo
pointu
acuto

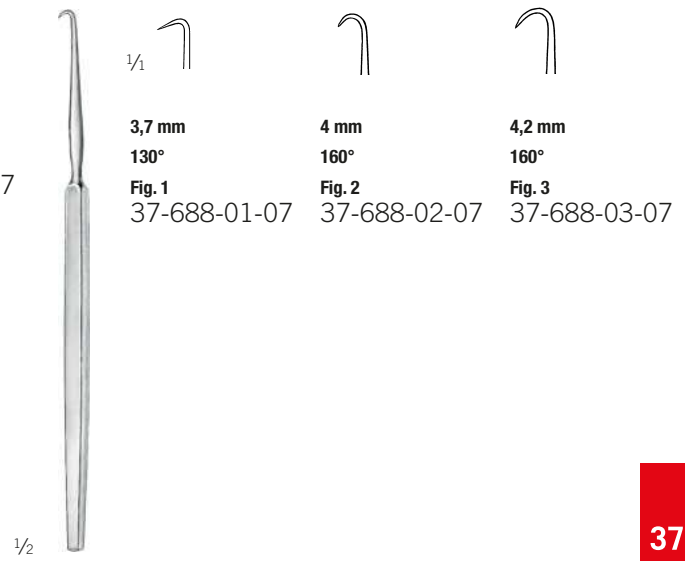

1/2
3,7 mm
130°
Fig. 1
37-688-01-07
4 mm
160°
Fig. 2
37-688-02-07
4,2 mm
160°
Fig. 3
37-688-03-07

Cottle
37-688-01-07 - 37-688-03-07
14,5 cm / 5 9/16"
scharf
sharp
agudo
pointu
acuto



1/2
Ø 2 mm
160°

Lange
37-692-22-07
23 cm / 9"
Nasenflügelhäkchen, Knopfende
Alar Hooklet, button end
Ganchito para alas de nariz, botonado
Crochet pour les ailes du nez, boutonné
Uncino per le pinne nasali, con fine a bottone



1/2
Ø 1,75 mm
160°

Fomon
37-694-17-07
17 cm / 6 6/8"
Nasenflügelhäkchen, Knopfende
Alar Hooklet, button end
Ganchito para alas de nariz, botonado
Crochet pour les ailes du nez, boutonné
Uncino per le pinne nasali, con fine a bottone

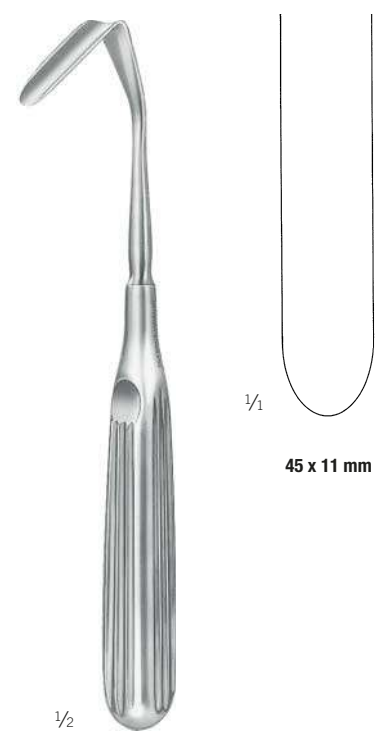

1/2
45 x 11 mm

Aufricht
37-697-19-07
19 cm / 7 4/8"
Nasenhaken
Nasal Retractors
Separadores nasales
Ecarteurs nasaux
Divaricatori nasali

Nasenflügelhäkchen, Schleimhauthäkchen

Alar Hooklets, Mucosa Hooklet

Ganchitos para alas de nariz, Ganchito para mucosa

Crochets pour les ailes du nez, Crochet pour la muqueuse

Uncini per le pinne nasali, Uncino per mucosa



1/2

Kilner
37-698-10-07

8 cm / 3 1/8"

scharf
sharp
agudo
pointu
acuto



1/2

Converse
37-699-11-07

10,5 cm / 4 1/8"

Nasenhaken
Nasal Retractors
Separadores nasales
Ecarteurs nasaux
Divaricatori nasali

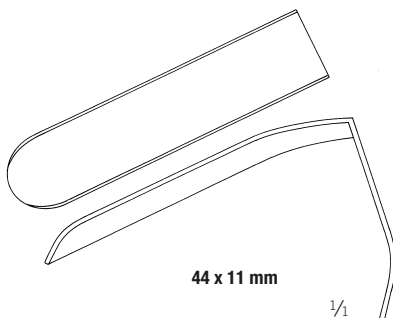

44 x 11 mm

1/4



1/2

Converse
37-700-12-07

11,5 cm / 4 5/8"

scharf
sharp
agudo
pointu
acuto



1/2

Freer
37-702-15-07

15 cm / 5 7/8"

scharf
sharp
agudo
pointu
acuto



1/2

Joseph
37-704-02-07 -
37-704-10-07

16 cm / 6 1/8"

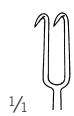

1/4

2 mm
37-704-02-07



5 mm
37-704-05-07



7 mm
37-704-07-07



10 mm
37-704-10-07

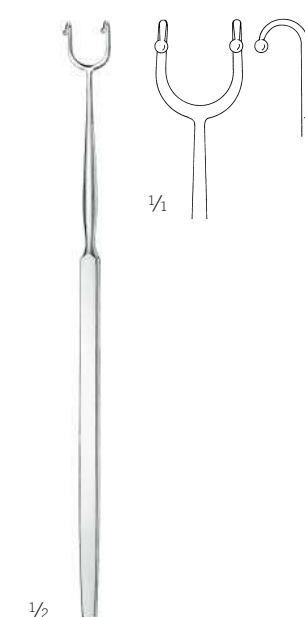

1/2

Fomon
37-706-16-07

16 cm / 6 2/8"

geknöpft
button ended
abotonado
boutonné
a bottone

Nasenflügelhäkchen, Nasenhaken

Alar Hooklets, Nasal Retractors

Ganchitos para alas de nariz, Separadores nasales

Crochets pour les ailes du nez, Ecarteurs nasaux

Uncini per le pinne nasali, Divaricatori nasali

Rhinologie

Rhinology

Rinología

Rhinologie

Rinologia

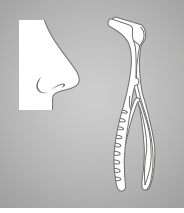

Cottle-Neivert
37-707-20-07
19,5 cm / 7 5/8"

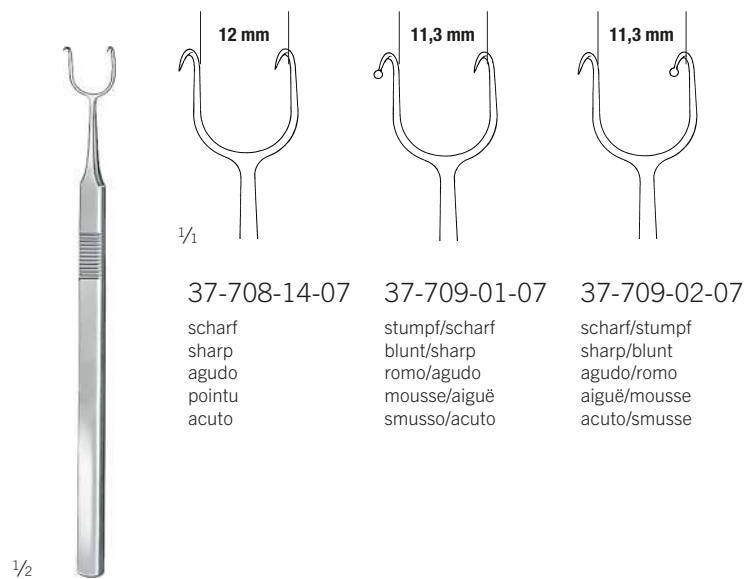

Cottle
37-708-14-07 -
37-709-02-07
14,5 cm / 5 9/8"

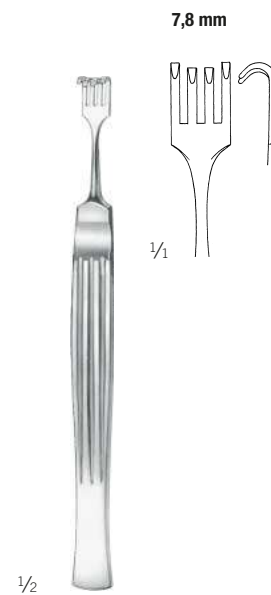

Cottle
37-710-14-07
14 cm / 5 4/8"

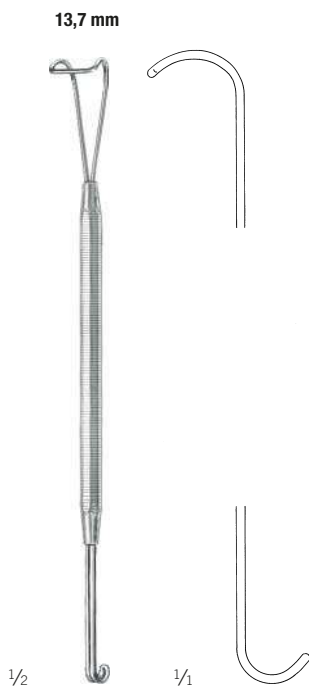

Neivert
37-712-16-07
17 cm / 6 6/8"



Cottle
37-713-15-07
14 cm / 5 4/8"
Sattelhäkchen
Saddle Hook
Separador en forma de silla
Élévateur sous forme de selle
Elevatori in forma di sella



Cottle
37-714-15-07
16 cm / 6 3/8"



Aufricht
37-715-14-07
12 cm / 4 6/8"
stumpf
blunt
romo
mousse
smusso

Blätter
blades
hojas
lames
lame
60 x 6,5 mm

Septumzangen, Septumrichtzangen

Septum Forceps, Septum Straightening Forceps

Pinzas para tabique nasal, Pinzas para enderezar el tabique nasal

Pinces pour la cloison nasale, Pincettes pour le redressement de la cloison nasale

Pinze per il setto nasale, Pinze per raddrizzare il setto nasale



37-724-01-07

gerade
straight
recta
droite
diritta

37-724-02-07

links
left
izquierdo
gauche
sinistra

37-724-03-07

rechts
right
derecho
droit
destra



1/2

Kressner
37-721-20-07
22 cm / 8 5/8"



1/2

Cottle-Walsham
37-724-01-07 -
37-724-03-07
23 cm / 9"



1/2

Asch
37-725-23-07
22,5 cm / 8 7/8"

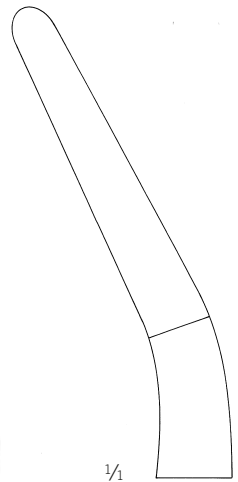

1/1

Hautfasspinzetten, Antrumküretten

Skin Grasping Forceps, Antrum Curettes
 Pinzas para piel, Curetas para el antro
 Pincés pour saisir la peau, Curettes pour l'antro
 Pinze per afferrare la pelle, Curette per antro

Rhinologie

Rhinology
 Rinología
 Rinologie
 Rinologia

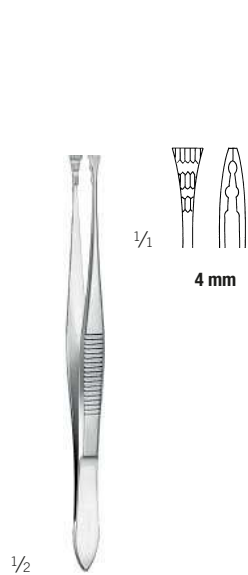
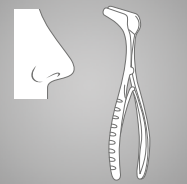

Ogura
 37-728-11-07
 11 cm / 4 3/8"

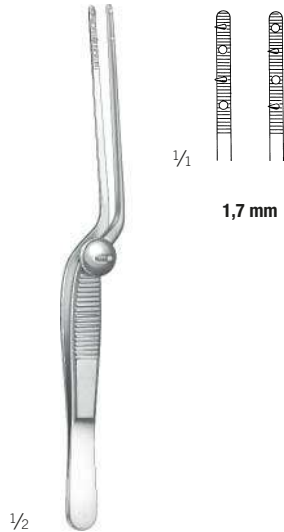

Cottle
 37-731-14-07
 14 cm / 5 1/2"
 mit Zähnen
 with teeth
 con dientes
 avec dents
 con denti

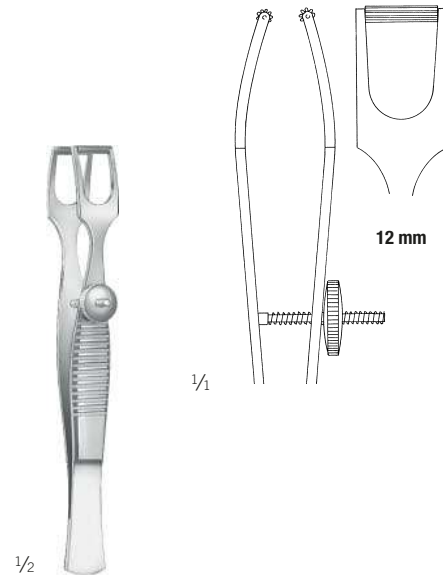

Cottle
 37-732-10-07
 11 cm / 4 3/8"
 Columellapinzette
 Columella Forceps
 Pinza para columela
 Pince à columella
 Pinza per columella

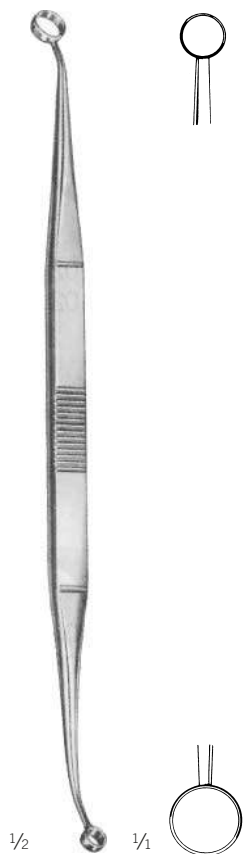

Faulkner
 37-742-21-07
 21 cm / 8 1/8"



Coakley
 37-748-01-07 -
 37-748-06-07
 17 cm / 6 5/8"

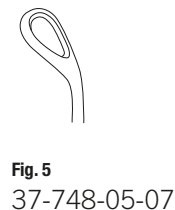
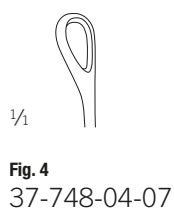
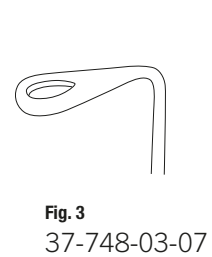
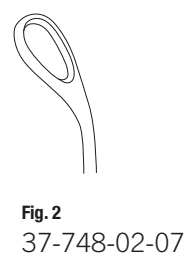
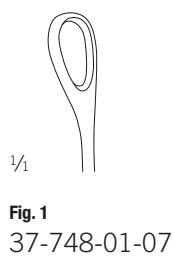

Ringmesser, Saugraspatorium, Sinus-Dilatatoren

Adenoid Currettes, Suction Raspatory, Frontal Sinus Dilators

Cuchillos para adenoides, Legra de succión, Dilatadores para el seno

Couteaux à végétations adénoïdales, Rugine-raspatoire à succion, Dilatateurs pour le sinus frontal

Coltelli per vegetazioni adenoidee, Rasparatorio con aspiratore, Dilatatori per il seno frontale



Fig. 1	37-755-01-07	13 mm
Fig. 2	37-755-02-07	15 mm
Fig. 3	37-755-03-07	17 mm
Fig. 4	37-755-04-07	19 mm
Fig. 5	37-755-05-07	21 mm
Fig. 6	37-755-06-07	23 mm

Beckmann
37-755-01-07 -
37-755-06-07
22 cm / 8 5/8"

1/2



Fig. 1	37-756-01-07	13 mm
Fig. 2	37-756-02-07	15 mm
Fig. 3	37-756-03-07	17 mm
Fig. 4	37-756-04-07	19 mm
Fig. 5	37-756-05-07	21 mm
Fig. 6	37-756-06-07	23 mm

Beckmann
37-756-01-07 -
37-756-06-07
21,5 cm / 8 4/8"

1/2



Ø 3,0 mm

37-814-30-07

1/2

Eicken-Killian
37-814-30-07
14 cm / 5 4/8"

Spülkanüle, mit Luer-Lock
Irrigation Cannula, with Luer-Lock
Sonda irrigadora para seno maxilar, con Luer-Lock
Canule à irrigation, avec Luer-Lock
Cannula per lavaggio, con Luer-Lock

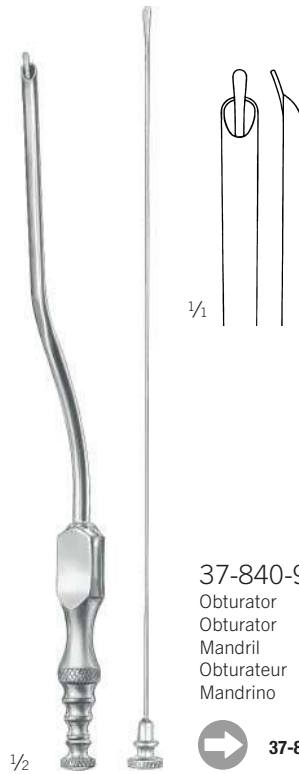

1/1

37-840-90-98
Obturator
Obturator
Mandril
Obturateur
Mandrino

➔ 37-840-20-01

1/2

Guilen
37-840-20-01
19 cm / 7 4/8"



Ø 3 mm

37-842-30-01

Ø 4 mm

37-842-40-01

1/2

Ritter-Halle
37-842-30-01 -
37-842-40-01
14,5 cm / 5 6/8"