

Otologie  
Otology  
Otología  
Otologie  
Otología

# 36



# Mikro-Ohrzängchen

Micro Ear Forceps  
 Micro pinzas auriculares  
 Micro Pince auriculaires  
 Micro Pinze auricolari

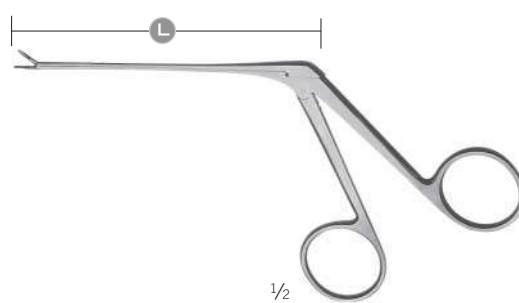
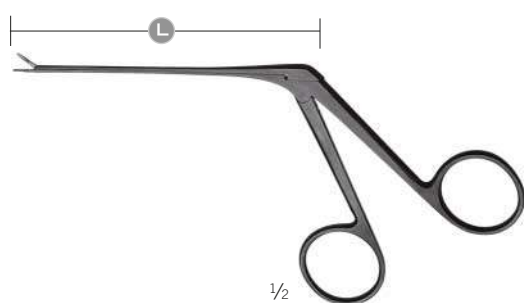
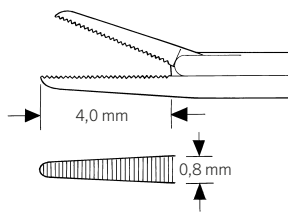
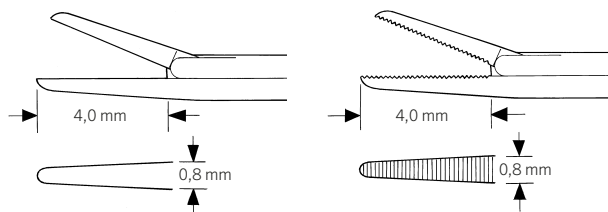

36-001-01-14 -  
 36-001-09-14

36-001-01-07 -  
 36-001-09-07

	gerade, glatt straight, smooth recta, lisa droite, lisse retta, liscia	gerade, gerieft straight, serrated recta, estriada droite, striée retta, con scanalatura	aufgebogen, gerieft bent upwards, serrated curva por arriba, estriada courbée v. le haut, striée curva in alto, con scanalatura	rechts, gerieft right, serrated derecha, estriada droite, striée destra, con scanalatura	links, gerieft left, serrated izquierda, estriada gauche, striée sinistra, con scanalatura
1/1					
L	<b>8 cm</b>	<b>8 cm</b>	<b>8 cm</b>	<b>8 cm</b>	<b>8 cm</b>
SB	36-001-01-14	36-001-06-14	36-001-07-14	36-001-08-14	36-001-09-14
St	36-001-01-07	36-001-06-07	36-001-07-07	36-001-08-07	36-001-09-07

## Mikro-Ohrzängchen

Micro Ear Forceps  
 Micro pinzas auriculares  
 Micro Pince auriculaires  
 Micro Pinze auricolari

## Otologie

Otology  
 Otología  
 Otologie  
 Otologia

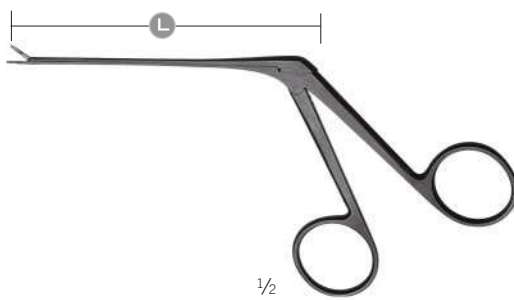
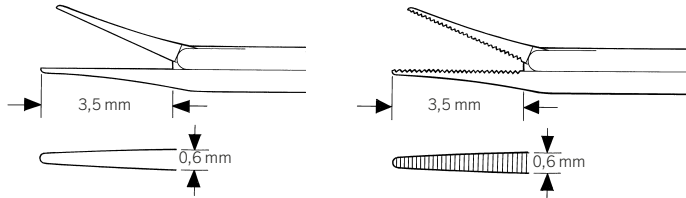

Mini-McGee  
 36-001-11-14 -  
 36-001-16-14

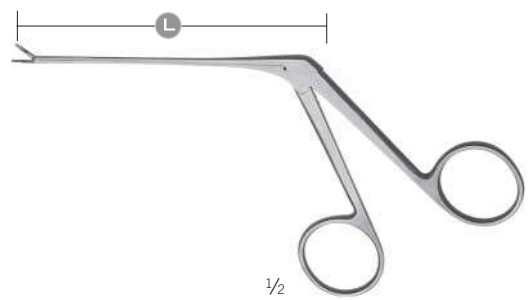

Mini-McGee  
 36-001-11-07 -  
 36-001-16-07

36

	<b>gerade, glatt</b> <b>straight, smooth</b> <b>recta, lisa</b> <b>droite, lisse</b> <b>retta, liscia</b>	<b>gerade, gerieft</b> <b>straight, serrated</b> <b>recta, estriada</b> <b>droite, striée</b> <b>retta, con scanalatura</b>
1/1		
L	<b>8 cm</b>	<b>8 cm</b>
SB	36-001-11-14	36-001-16-14
St	36-001-11-07	36-001-16-07

# Mikro-Ohrzängchen

Micro Ear Forceps  
 Micro pinzas auriculares  
 Micro Pince auriculaires  
 Micro Pinze auricolari

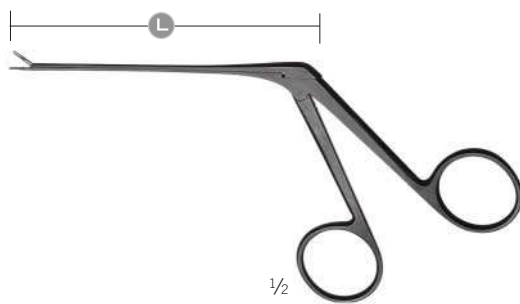
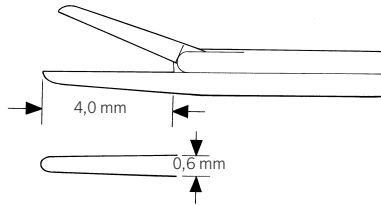

36-001-21-14

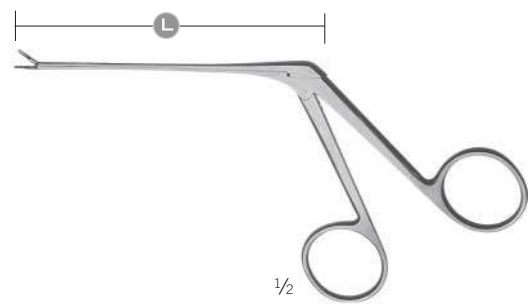

36-001-21-07

	<p><b>gerade, glatt</b>  <b>straight, smooth</b>  <b>recta, lisa</b>  <b>droite, lisse</b>  <b>retta, liscia</b></p>
1/1	
L	<b>8 cm</b>
SB	36-001-21-14
St	36-001-21-07

# Mikro-Ohrzängchen

Micro Ear Forceps  
 Micro pinzas auriculares  
 Micro Pince auriculaires  
 Micro Pinze auricolari

# Otologie

Otology  
 Otología  
 Otologie  
 Otologia

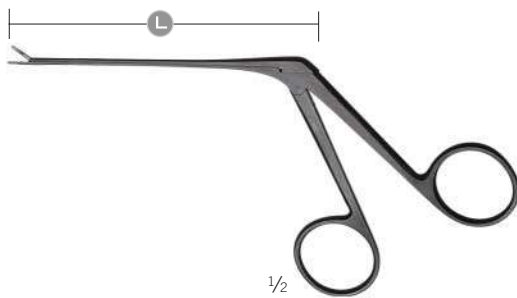
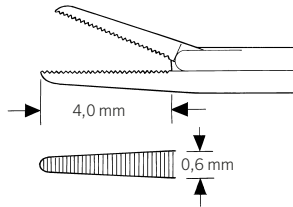
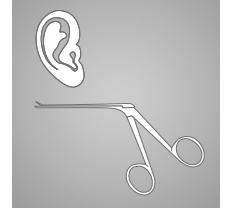

36-001-26-14

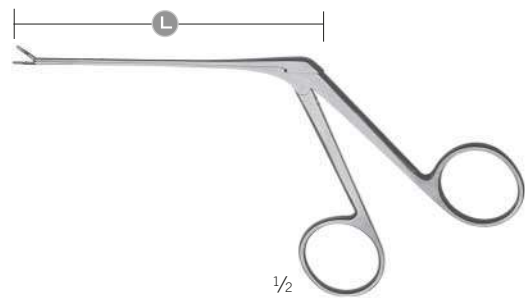

36-001-26-07

36

	gerade, gerieft straight, serrated recta, estriada droite, striée retta, con scanalatura
1/1	
L	8 cm
SB	36-001-26-14
St	36-001-26-07

# Mikro-Ohrzängchen

Micro Ear Forceps  
 Micro pinzas auriculares  
 Micro Pince auriculaires  
 Micro Pinze auricolari

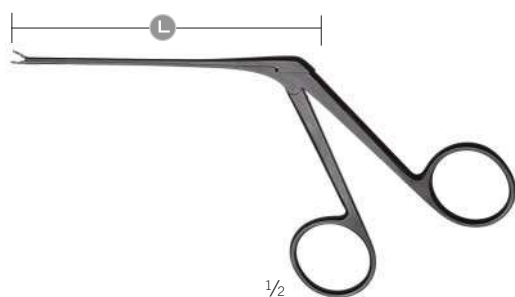
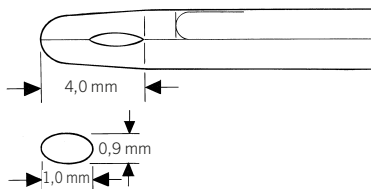

36-003-01-14 -  
 36-003-04-14

Löffel  
 cup  
 cucharilla  
 curette  
 cucchiaino

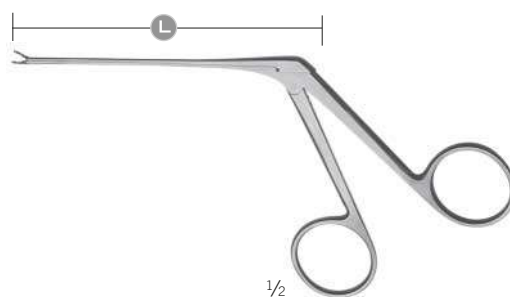

36-003-01-07 -  
 36-003-04-07

Löffel  
 cup  
 cucharilla  
 curette  
 cucchiaino

	gerade straight recta droite retta	aufgebogen bent upwards curva por arriba courbée en haut curva in alto	rechts right derecha droite destra	links left izquierda gauche sinistra
1/1				
L	8 cm	8 cm	8 cm	8 cm
SB	36-003-01-14	36-003-02-14	36-003-03-14	36-003-04-14
St	36-003-01-07	36-003-02-07	36-003-03-07	36-003-04-07

# Mikro-Ohrzängchen

Micro Ear Forceps  
 Micro pinzas auriculares  
 Micro Pince auriculaires  
 Micro Pinze auricolari

# Otologie

Otology  
 Otología  
 Otologie  
 Otologia

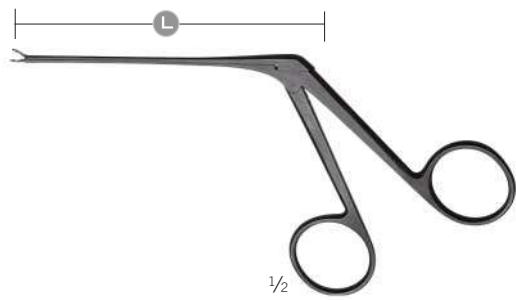
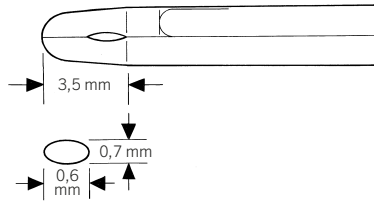
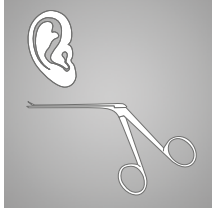

Mini-McGee  
 36-003-11-14 -  
 36-003-14-14

Löffel  
 cup  
 cucharilla  
 curette  
 cucchiaino

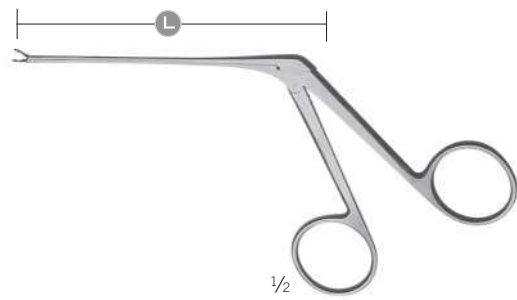

Mini-McGee  
 36-003-11-07 -  
 36-003-14-07

Löffel  
 cup  
 cucharilla  
 curette  
 cucchiaino

36

	gerade straight recta droite retta	aufgebogen bent upwards curva por arriba courbée en haut curva in alto	rechts right derecha droite destra	links left izquierda gauche sinistra
1/1				
L	8 cm	8 cm	8 cm	8 cm
SB	36-003-11-14	36-003-12-14	36-003-13-14	36-003-14-14
St	36-003-11-07	36-003-12-07	36-003-13-07	36-003-14-07

# Mikro-Ohrscherchen

Micro Ear Scissors

Micro tijeras auriculares

Micro Ciseaux auriculaires

Micro Forbici auricolari

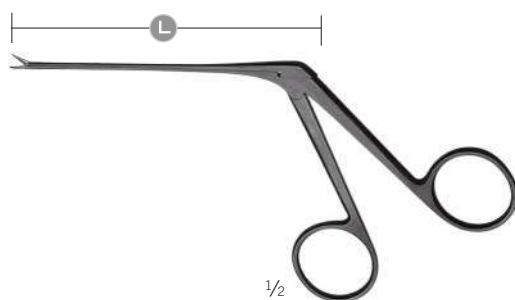
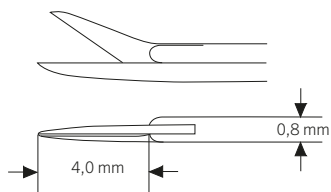

Bellucci  
36-005-01-14 -  
36-005-04-14

sehr fein  
very delicate  
muy fino  
très fin  
strafino

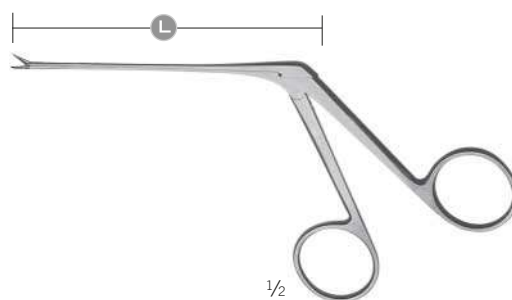

Bellucci  
36-005-01-07 -  
36-005-04-07

sehr fein  
very delicate  
muy fino  
très fin  
strafino

	gerade straight recta droite retta	aufgebogen bent upwards curva por arriba courbée en haut curva in alto	rechts right derecha droite destra	links left izquierda gauche sinistra
1/1				
L	8 cm	8 cm	8 cm	8 cm
SB	36-005-01-14	36-005-02-14	36-005-03-14	36-005-04-14
St	36-005-01-07	36-005-02-07	36-005-03-07	36-005-04-07

## Mikro-Ohrscherchen

Micro Ear Scissors  
 Micro tijeras auriculares  
 Micro Ciseaux auriculaires  
 Micro Forbici auricolari

## Otologie

Otology  
 Otología  
 Otologie  
 Otologia

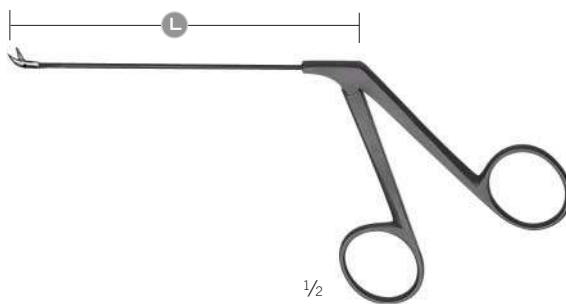
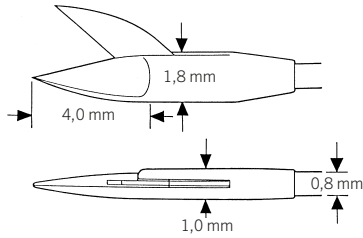

Wullstein  
 36-005-51-14 -  
 36-005-54-14

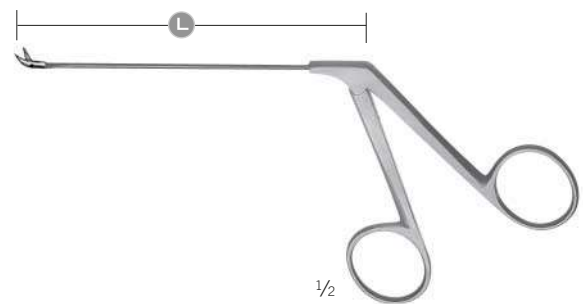

Wullstein  
 36-005-51-07 -  
 36-005-54-07

36

	gerade straight recta droite retta	aufgebogen bent upwards curva por arriba courbée en haut curva in alto	rechts right derecha droite destra	links left izquierda gauche sinistra
1/1				
L	9 cm	9 cm	9 cm	9 cm
SB	36-005-51-14	36-005-52-14	36-005-53-14	36-005-54-14
St	36-005-51-07	36-005-52-07	36-005-53-07	36-005-54-07

## Mikro-Ohrzängchen

Micro Ear Forceps  
 Micro pinzas auriculares  
 Micro Pince auriculaires  
 Micro Pinze auricolari

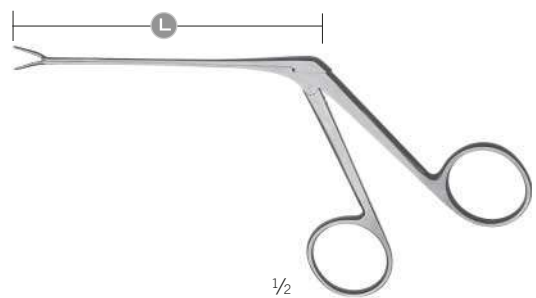
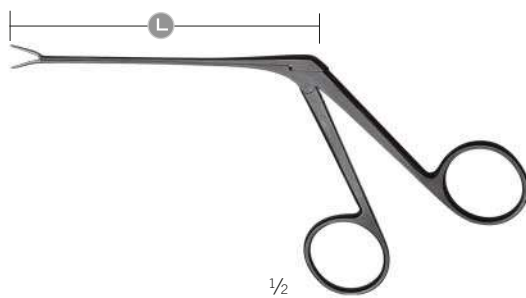
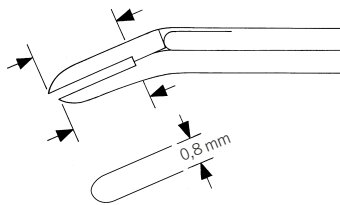

McGee  
 36-010-11-14 -  
 36-010-12-14

Drahtbiegezängchen  
 Wire Bending Forceps  
 Pinza para plegar alambre  
 Pince à plier les fils d'acier  
 Pinza per piegare fili metallici

McGee  
 36-010-11-07 -  
 36-010-12-07

Drahtbiegezängchen  
 Wire Bending Forceps  
 Pinza para plegar alambre  
 Pince à plier les fils d'acier  
 Pinza per piegare fili metallici

	<b>abgewinkelt</b> <b>angled downward</b> <b>acodado abajo</b> <b>angulé vers le bas</b> <b>angolato verso il basso</b>	<b>abgewinkelt</b> <b>angled downward</b> <b>acodado abajo</b> <b>angulé vers le bas</b> <b>angolato verso il basso</b>
1/1	 <b>0,8 x 3,5 mm</b>	 <b>0,8 x 6 mm</b>
L	<b>8 cm</b>	<b>8 cm</b>
SB	36-010-11-14	36-010-12-14
St	36-010-11-07	36-010-12-07

# Mikro-Ohrzängchen

Micro Ear Forceps  
 Micro pinzas auriculares  
 Micro Pince auriculaires  
 Micro Pinze auricolari

# Otologie

Otology  
 Otolología  
 Otologie  
 Otologia

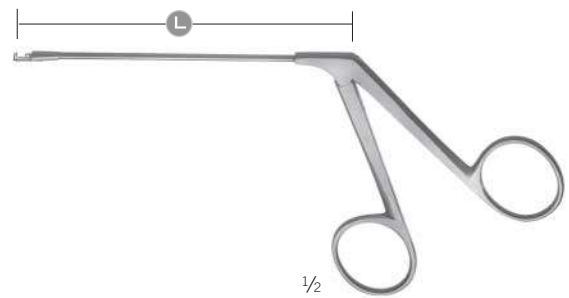
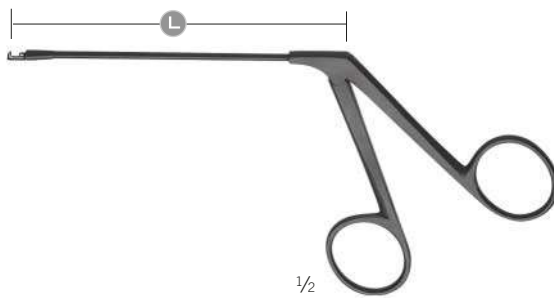
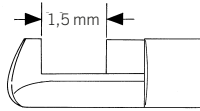
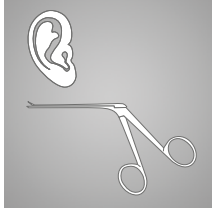

House-Dieter  
 36-011-01-14 -  
 36-011-07-14  
 Hammerkopfzängchen  
 Malleus Nipper  
 Pinza para cabezal del maléolo  
 Pince pour l'os marteau  
 Pinza per testa del martelletto

House-Dieter  
 36-011-01-07 -  
 36-011-07-07  
 Hammerkopfzängchen  
 Malleus Nipper  
 Pinza para cabezal del maléolo  
 Pince pour l'os marteau  
 Pinza per testa del martelletto

	oben schneidend up-cutting corte arriba tranchante en haut tagliente in alto	unten schneidend down-cutting corte abajo tranchante en bas tagliente in basso	rechts schneidend right-cutting corte derecho tranchant à droite tagliente a destra	links schneidend left-cutting corte izquierdo tranchant à gauche tagliente a sinistra
1/1				
L	9 cm	9 cm	9 cm	9 cm
SB	36-011-01-14	36-011-02-14	36-011-06-14	36-011-07-14
St	36-011-01-07	36-011-02-07	36-011-06-07	36-011-07-07

## Mikro-Ohrzängchen

Micro Ear Forceps

Micro pinzas auriculares

Micro Pince auriculaires

Micro Pinze auricolari

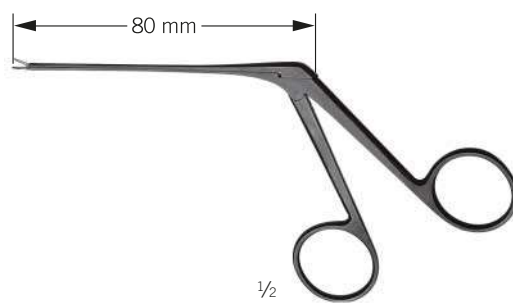
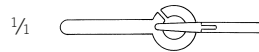

Fuller

36-013-01-14 

Einführungszängchen, für Teflonprothesen  
Introducing Forceps, for teflon prosthesis  
Pinza para introducir, para prótesis de teflon  
Pince pour introduction, pour prothèse en téflon  
Pinza per introduzione, per protesi in teflon

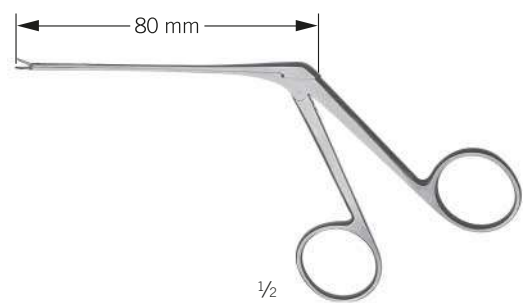

Fuller

36-013-01-07 

Einführungszängchen, für Teflonprothesen  
Introducing Forceps, for teflon prosthesis  
Pinza para introducir, para prótesis de teflon  
Pince pour introduction, pour prothèse en téflon  
Pinza per introduzione, per protesi in teflon

## Mikro-Ohrmesser

Micro Ear Knives

Micro cuchillos auriculares

Micro Couteaux auriculaires

Micro Coltelli

## Otologie

Otology

Otología

Otologie

Otologia



Schuknecht  
36-020-06-07

14,5 cm / 5 9/16"

Sichelmesser  
Sickle Knife  
Cuchillo de hoz  
Synéchiotome  
Coltello falcato  
come sinechia



Wullstein  
36-020-11-07

15,5 cm / 6 1/8"

Sichelmesser  
Sickle Knife  
Cuchillo de hoz  
Synéchiotome  
Coltello falcato  
come sinechia



Tabb  
36-020-16-07

15,5 cm / 6 1/8"

Schleimhautmesser  
Mucosa Knife  
Cuchillo para mucosa  
Couteau pour muqueuse  
Bisturi per mucosa



Plester  
36-020-21-07

15 cm / 5 7/8"

Lappenmesser  
Flap Knife  
Cuchillo para lóbulos  
Couteau lobaire  
Coltello per lobi



1/2

Rosen  
36-022-01-07 -  
36-022-07-07

15 cm / 5 7/8"

36-022-01-07	Fig. 1	Ø 3,0 mm	
36-022-02-07	Fig. 2	Ø 2,8 mm	
36-022-03-07	Fig. 3	Ø 2,6 mm	
36-022-04-07	Fig. 4	Ø 2,0 mm	
36-022-05-07	Fig. 5	Ø 1,6 mm	
36-022-06-07	Fig. 6	Ø 1,4 mm	
36-022-07-07	Fig. 7	Ø 1,0 mm	

## Mikro-Ohrhäkchen, Mikro-Ohrnadeln

Micro Ear Hooks, Micro Ear Needles

Micro ganchitos auriculares, Micro agujas auriculares

Micro Crochets auriculaires, Micro Aiguilles auriculaires

Micro Uncini auricolari, Micro Aghi auricolari

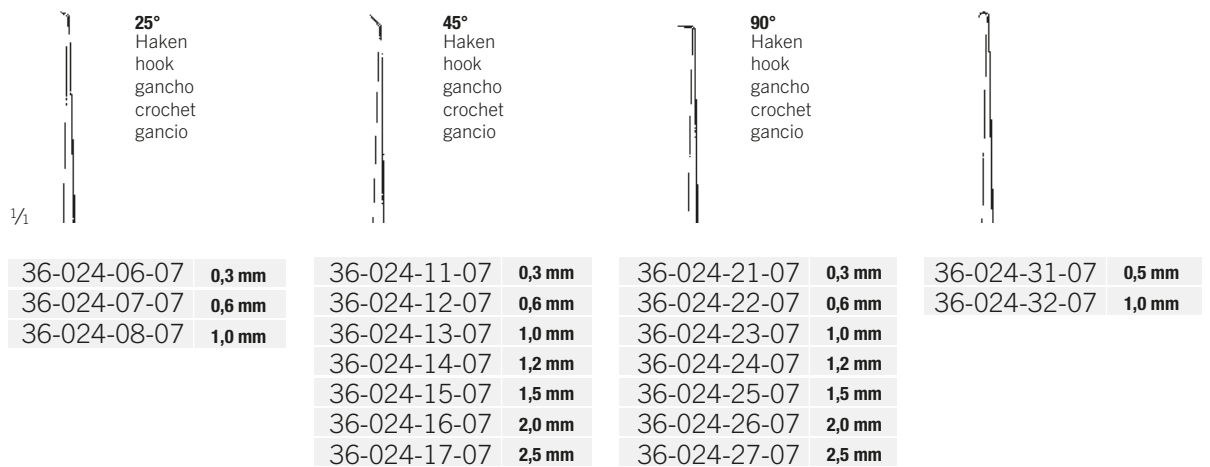
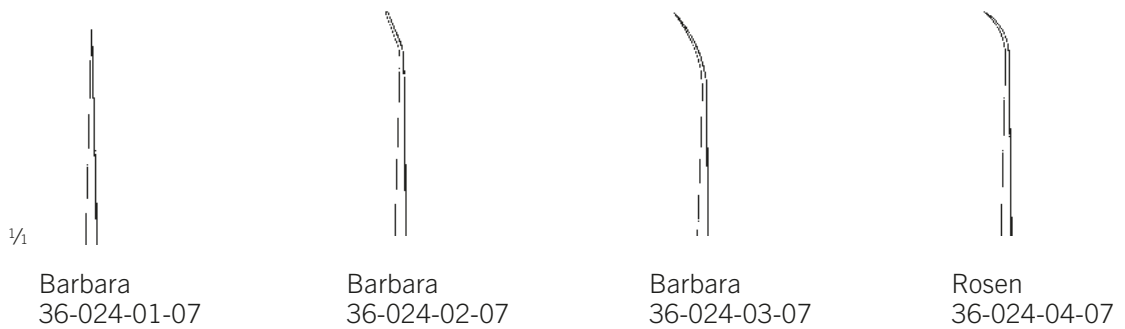

36-024-01-07 -  
36-024-32-07  
16 cm / 6 2/8"

## Mikro-Ohrhäkchen, Mikro-Ohrnadeln

Micro Ear Hooks, Micro Ear Needles

Micro ganchitos auriculares, Micro agujas auriculares

Micro Crochets auriculaires, Micro Aiguilles auriculaires

Micro Uncini auricolari, Micro Aghi auricolari

## Otologie

Otology

Otología

Otologie

Otologia



1/1

aufgewinkelt  
bent upwards  
angulado hacia arriba  
coudé en haut  
angolato in alto  
**90°**

abgewinkelt  
angled  
angulada  
coudée  
angolata  
**90°**



aufgebogen  
bent upwards  
angulado hacia arriba  
coudé en haut  
angolato in alto



abgewinkelt  
angled  
angulada  
coudée  
angolata

McGee

McGee

36-025-01-07	0,3 mm
36-025-02-07	0,6 mm
36-025-03-07	1,0 mm

36-025-06-07	0,3 mm
36-025-07-07	0,6 mm
36-025-08-07	1,0 mm

36-027-01-07	0,5 mm
36-027-02-07	1,0 mm

36-027-11-07	0,5 mm
36-027-12-07	1,0 mm

für Fußplatte  
for footplate  
para la platina estapediense  
pour la platine de l'étrier  
per la piedistallo

für Fußplatte  
for footplate  
para la platina estapediense  
pour la platine de l'étrier  
per la piedistallo

1/2

36-025-01-07 -  
36-027-12-07

15,5 cm / 6 1/8"



1/2

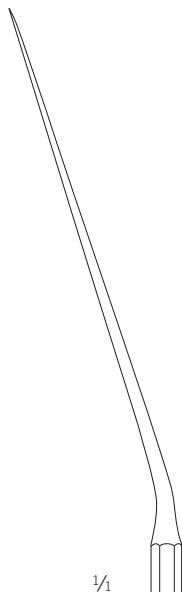

1/1

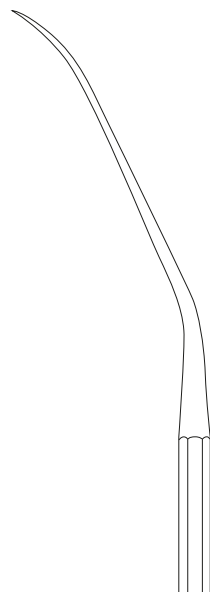

Barbara  
36-029-01-07 -  
36-029-06-07

15,5 cm / 6 1/8"

36-029-01-07

36-029-06-07

## Mikro-Ohrhäkchen, Mikro-Dissektoren

Micro Ear Hooks, Micro Dissectors

Micro ganchitos auriculares, Micro disecadores

Micro Crochets auriculaires, Micro Dissecteurs

Micro Uncini auricolari, Micro Dissettori

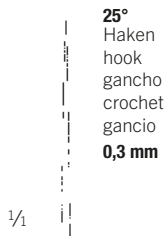

36-030-06-07



36-030-07-07



Shambaugh  
36-030-08-07



36-030-11-07

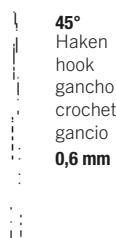

36-030-12-07



Shambaugh  
36-030-13-07



Shea  
36-030-20-07

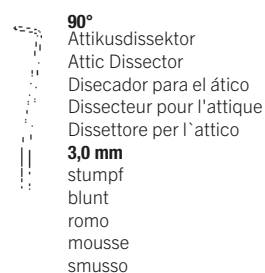

Austin  
36-030-30-07

36-030-06-07 -  
36-030-30-07  
15 cm / 5 7/8"



36-036-01-07

15 cm / 5 7/8"

nach rechts abgewinkelt  
angled to right  
angulada por derecha  
coudée vers droite  
angulata a destra



36-036-02-07

15 cm / 5 7/8"

nach links abgewinkelt  
angled to left  
angulada por izquierda  
coudée vers gauche  
angulata a sinistra



36-036-05-07

15,5 cm / 6 1/8"

nach rechts abgewinkelt  
angled to right  
angulada por derecha  
coudée vers droite  
angulata a destra



36-036-06-07

15,5 cm / 6 1/8"

nach links abgewinkelt  
angled to left  
angulada por izquierda  
coudée vers gauche  
angulata a sinistra



1,2 mm

Fisch  
36-036-01-07 -  
36-036-06-07

Rosen  
36-036-23-07  
15 cm / 5 7/8"

Mikro-Ohrspasatorium  
Micro Ear Periosteal Elevator  
Micro Legra auricular  
Micro Rugine-Raspatoire auriculaire  
Micro Raspatore auricolare

## Mikro-Küretten, Mikro-Messsonden

Micro Curettes, Micro Measuring Rods  
 Micro cucharillas, Micro Sondas para medir  
 Micro Curettes, Micro Sondes pour mesurer  
 Micro cucchiari, Micro Sonde per misurare

## Otologie

Otology  
 Otología  
 Otologie  
 Otologia



36-038-01-07

Markierung bis  
 Marking up to  
 Manchar hasta  
 Marquage jusque  
 Marcatura fino a  
**3,5 mm**



36-038-02-07

Markierung bis  
 Marking up to  
 Manchar hasta  
 Marquage jusque  
 Marcatura fino a  
**4,0 mm**



36-038-03-07

Markierung bis  
 Marking up to  
 Manchar hasta  
 Marquage jusque  
 Marcatura fino a  
**4,5 mm**

House

36-038-01-07 -  
 36-038-03-07

15,5 cm / 6 1/8"

36



Ø 1,0 mm

36-044-01-07



Ø 1,5 mm

36-044-02-07



Ø 1,0 mm

36-044-03-07

Ø 1,2 mm

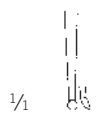

1/4

Ø 1,8 mm



Ø 1,2 mm



1/4

House

36-044-01-07 -  
 36-044-03-07

14,5 cm / 5 7/8"

## Ohrspekula

Ear Specula

Espéculos auriculares

Spéculums auriculaires

Specoli auricolari

St



1/2

0

1

2

3

4

Fig. 0	Fig. 1	Fig. 2	Fig. 3	Fig. 4
Ø 3,0 mm	Ø 4,0 mm	Ø 5,0 mm	Ø 6,0 mm	Ø 7,5 mm
36-112-10-01	36-112-11-01	36-112-12-01	36-112-13-01	36-112-14-01

Hartmann

36-112-03-01 -

36-115-04-01

3,6 cm / 1 3/8"

Fig. 0 - 2	Fig. 2 - 4	Fig. 1 - 4
36-112-03-01	36-114-03-01	36-115-04-01
Ohrspekula, Satz, Ear Specula, set Espéculos auriculares, juego Spéculums auriculaires, jeu Specoli auricolari, set  für Kinder for children para niños pour enfants per bambini	Ohrspekula, Satz, Ear Specula, set Espéculos auriculares, juego Spéculums auriculaires, jeu Specoli auricolari, set  für Erwachsene for adults para adultos pour adultes per adulti	Ohrspekula, Satz, Ear Specula, set Espéculos auriculares, juego Spéculums auriculaires, jeu Specoli auricolari, set  für Erwachsene for adults para adultos pour adultes per adulti

St



1/2

1/2

1

2

3

4

Fig. 1	Fig. 2	Fig. 3	Fig. 4
Ø 4,0 mm	Ø 5,0 mm	Ø 6,0 mm	Ø 7,5 mm
36-118-11-01	36-118-12-01	36-118-13-01	36-118-14-01

Toynbee

36-118-03-01 -

36-119-04-01

3,6 cm / 1 3/8"

Fig. 2 - 4	Fig. 1 - 4
36-118-03-01	36-119-04-01
Ohrspekula, Satz, Ear Specula, set Espéculos auriculares, juego Spéculums auriculaires, jeu Specoli auricolari, set  für Erwachsene for adults para adultos pour adultes per adulti	Ohrspekula, Satz, Ear Specula, set Espéculos auriculares, juego Spéculums auriculaires, jeu Specoli auricolari, set  für Erwachsene for adults para adultos pour adultes per adulti

## Ohrspekula

Ear Specula  
Espéculos auriculares  
Spéculums auriculaires  
Specoli auricolari

## Otologie

Otology  
Otología  
Otologie  
Otologia



St  
18/8



1/2



Fig. 1	Fig. 2	Fig. 3	Fig. 4	Fig. 5	Fig. 6	Fig. 7
Ø 5,5 mm	Ø 6,5 mm	Ø 7,5 mm	Ø 8,5 mm	Ø 9,5 mm	Ø 10,5 mm	Ø 11,5 mm
36-134-01-07	36-134-02-07	36-134-03-07	36-134-04-07	36-134-05-07	36-134-06-07	36-134-07-07

## Farrior

36-134-01-07 -

36-134-07-07

3,6 cm / 1 3/8"

rund  
round  
redondo  
ronde  
rotondo



1/2

## 36-148-12-01

Ohrspekulaständer  
Ear Specula Storage Rack  
Soporte para espéculos auriculares  
Support pour spéculums auriculaires  
Supporto per specoli auricolari

# Stimmgabeln

Tuning Forks

Diapasónes

Diapasons

Diapason



1/2

French  
36-170-07-04

C<sub>2</sub> 16



1/2

French  
36-172-08-04

C<sub>1</sub> 32



1/2

Hartmann  
36-174-09-04

C 64



1/2

Hartmann  
36-175-10-04

C 128



1/2

Hartmann  
36-177-11-04

C<sup>1</sup> 256

# Stimmgabeln

Tuning Forks  
Diapasónes  
Diapasons  
Diapason

# Otologie

Otology  
Otología  
Otologie  
Otologia



1/2

Martin  
36-180-10-04   
**C 128**



1/2

Martin  
36-182-11-04   
**C 256**



1/2

Martin-Alloy  
36-184-12-04   
**C 512**



1/2

Martin-Alloy  
36-186-13-04   
**C 1024**



1/2

Martin-Alloy  
36-188-14-04   
**C 2048**

36



1/2

Hartmann  
36-189-10-04  
**C 128**



1/2

Hartmann  
36-192-11-04  
**C¹ 256**



1/2

Hartmann  
36-194-12-04  
**C² 512**



1/2

Hartmann  
36-196-13-04  
**C³ 1024**



1/2

Hartmann  
36-198-14-04  
**C⁴ 2048**



1/2

Hartmann  
36-200-15-04  
**C⁵ 4096**

# Stimmgabeln

Tuning Forks

Diapasónes

Diapasons

Diapason



36-216-90-98

Fuss, allein  
Socket, only  
Pedestal, suelto  
Socle, seul  
Zoccolo, solo

Lucae  
36-210-10-04  
**C 128**

Lucae  
36-212-11-04  
**C1 256**

Lucae  
36-214-12-04  
**C2 512**

Lucae  
36-216-13-04  
**C3 1024**

Lucae  
36-218-14-04  
**C4 2048**

Lucae  
36-220-15-04  
**C5 4096**

1/2



1/1

36-221-91-98

Fuss, allein  
Socket, only  
Pedestal, suelto  
Socle, seul  
Zoccolo, solo

1/2

Lucae  
36-221-10-04 - 36-221-91-98

**C 128**

verschiebbar bis h  
moveable up to h  
regulable hasta h  
réglable jusqu'à h  
regolabile fino a h

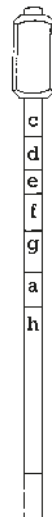

1/1

1/2

Hartmann  
36-222-10-04

**C 128**

verschiebbar bis h  
moveable up to h  
regulable hasta h  
réglable jusqu'à h  
regolabile fino a h



1/2

36-223-90-98

Fuss, allein  
Socket, only  
Pedestal, suelto  
Socle, seul  
Zoccolo, solo

Hartmann  
36-223-11-04 - 36-223-90-98

**C1 256**

## Stimmgabeln

Tuning Forks  
Diapasones  
Diapasons  
Diapason

## Otologie

Otology  
Otología  
Otologie  
Otologia



36-224-90-98

Dämpfer  
Dampfer  
Sordina  
Curseur  
Sordina  
weiße Skala  
white scale  
balanza blanca  
l'échelle graduée blanche  
scala bianca



36-224-10-04

36-224-91-98

Dämpfer  
Dampfer  
Sordina  
Curseur  
Sordina  
schwarze Skala  
black scale  
balanza negra  
l'échelle graduée noire  
scala nera



36-224-10-04

36-224-92-98

Rändelschraube  
Knurled screw  
Tornillo moleteado  
Vis moletée  
testa zigrinata



36-224-10-04

36-224-93-98

Gewichte, C 64  
Weights, C 64  
Pesas, C 64  
Poids, C 64  
Pesi, C 64



36-224-10-04



1/2

1/2

1/2

1/2

Rydel-Seiffert  
36-224-10-04

**C 64 / c 128**

auch für Neurologie  
also for neurology  
también para neurología  
aussi pour la neurologia  
anche per neurologia

Neuro  
36-226-00-04

mit Hammer, Nadelrad, Pinsel und Nadel  
with hammer, pinwheel, brush and needle  
con martillo, rueda con espinas, cepillo y aguja  
avec marteaux, roue aux épines, brosette et aiguille  
con martello, algesimetro, pennello ed ago

König  
36-230-59-04

**A 109**

verschiebbar bis g  
moveable up to g  
regulable hasta g  
réglable jusqu'à g  
regolabile fino a g

36-234-90-98

Bakelitfuß  
Bakelit base  
Base de Bakelit  
Base de Bakelit  
Base di Bakelit



36-234-61-04



36-234-61-04

**a<sup>1</sup> 440**

# Ohrkatheter, Polypenschnürer

Ear Catheters, Polypus Snares  
 Sondas auriculares, Polipótomos  
 Sondes auriculaires, Serre-noeuds  
 Sonde auricolari, Serranodi



Fig. 1	Fig. 2	Fig. 3
Ø 3,0 mm	Ø 3,5 mm	Ø 4,0 mm
36-321-01-01	36-321-02-01	36-321-03-01

Hartmann  
 36-321-01-01 -  
 36-321-03-01  
 15 cm / 5 7/8"

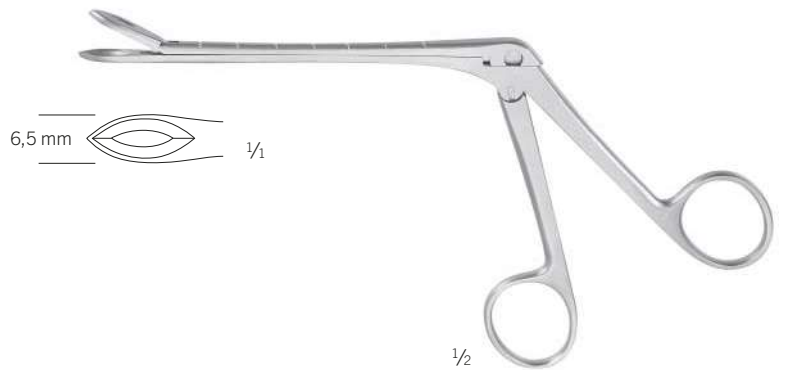

36-316-11-07  
 Schaftlänge  
 shaft length  
 longitud del vástago  
 longueur de la tige  
 lunghezza dell'asta  
**110 mm**



Krause  
 36-351-16-07  
 18,5 cm / 7 2/8"  
 offenes Ende  
 open tip  
 punta abierta  
 pointe ouverte  
 punta aperta



Krause-Voss  
 36-353-16-07  
 18,5 cm / 7 2/8"  
 geschlossenes Ende  
 closed tip  
 punta cerrada  
 pointe fermée  
 punt chiusa

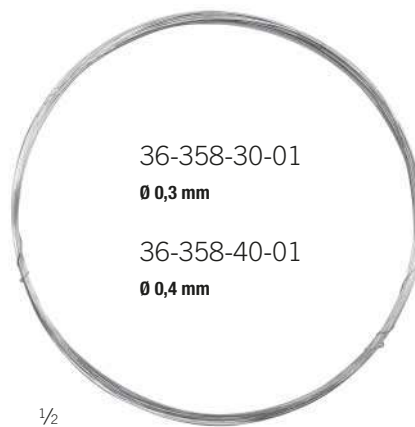

36-358-30-01  
**Ø 0,3 mm**  
 36-358-40-01  
**Ø 0,4 mm**  
 36-351-16-07,  
 36-353-16-07  
 Schnürdraht, Rolle mit 10 m  
 Snare Wire, coil of 10 m  
 Alambre, rollo de 10 m  
 Serre-noeuds, en rouleaux de 10 m  
 Filo in acciaio, rotolo di 10 m

## Ohrpinzetten

Ear Forceps  
Pinzas auriculares  
Pincas auriculaires  
Pinze auricolari

## Otologie

Otology  
Otología  
Otologie  
Otologia

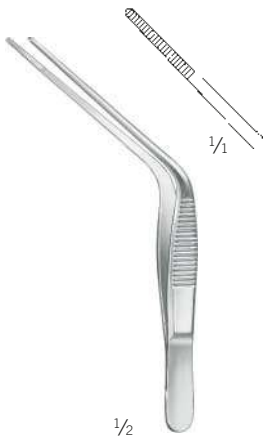

Tröltsch (Wilde)  
36-371-11-07  
10,5 cm / 4 1/8"



Tröltsch (Wilde)  
36-375-12-07  
11 cm / 4 3/8"

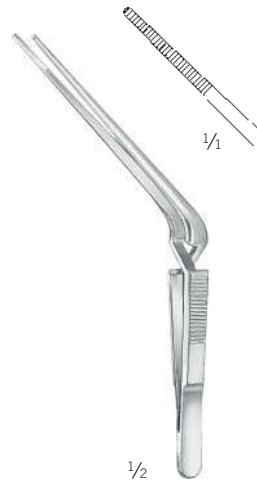

Tröltsch (Wilde)  
36-381-13-07  
12,5 cm / 4 7/8"

36



Grünwald  
36-391-14-07  
14,5 cm / 5 7/8"



Jansen  
36-395-16-07  
16 cm / 6 2/8"  
36-395-20-07  
21,5 cm / 8 4/8"

## Ohrpolypenzangen

Ear Polypus Forceps

Pinzas para pólipos auriculares

Pinces pour polypes auriculaires

Pinze per polipi auricolari

1/1 



Hartmann  
36-405-12-07

feines Modell	Schaftlänge
delicate pattern	shaft length
modelo delicado	longitud del vástago
modèle fin	longueur de la tige
modello fino	lunghezza dell'asta

**65 mm**

1/1 



Hartmann  
36-407-14-07

normales Modell	Schaftlänge
regular model	shaft length
modelo regular	longitud del vástago
modèle normal	longueur de la tige
modello normale	lunghezza dell'asta

**65 mm**

1/1 



Buck  
36-416-11-07

11,5 cm / 4 1/8"

Fremdkörperzängchen
Foreign Body Lever
Elevador para cuerpos extraños
Pince pour polypes auriculaires
Pinza per corpi estranei

# Ohrpolypenzangen

Ear Polypus Forceps  
 Pinzas para pólipos auriculares  
 Pincas pour polypes auriculaires  
 Pinze per polipi auricolari

# Otologie

Otology  
 Otología  
 Otologie  
 Otologia

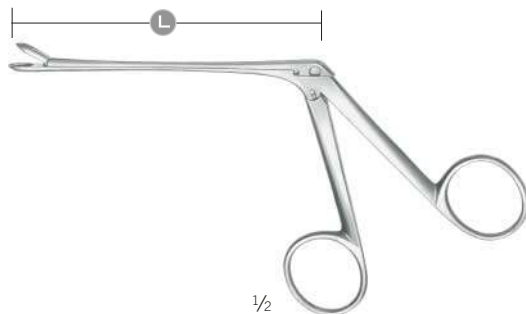
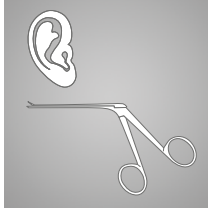

36-425-08-07 -  
 36-456-08-07

	<b>Hartmann-Wullstein</b>	<b>Hartmann-Wullstein</b>
1/1		
<b>L</b>	<b>8,5 cm</b>	<b>8,5 cm</b>
	36-425-08-07	36-427-08-07

	<b>Hartmann</b>	<b>Hartmann</b>
1/1		
<b>L</b>	<b>8,5 cm</b>	<b>14 cm</b>
	36-430-08-07	36-430-14-07

	<b>Hartmann-Herzfeld</b>	<b>Hartmann-Herzfeld</b>	<b>Hartmann-Herzfeld</b>
1/1			
	○ Ø 2,0 mm	○ Ø 2,5 mm	○ Ø 3,0 mm
<b>L</b>	<b>8,5 cm</b>	<b>8,5 cm</b>	<b>8,5 cm</b>
	36-442-81-07	36-442-82-07	36-442-83-07

	<b>Hartmann-Wullstein</b>	<b>Strümpel</b>	<b>Hartmann-Hoffmann</b>
1/1			
	○ Ø 3,0 mm		
<b>L</b>	<b>8,5 cm</b>	<b>8,5 cm</b>	<b>8,5 cm</b>
	36-445-08-07	36-448-08-07	36-456-08-07

## Ohr-Knochenstanzen

Mastoid Rongeurs

Pinzas cortantes para huesos

Ostéotomes emporte-pièces

Pinze osteotomi



1/2

Citelli  
36-461-17-07

<b>Maulbreite</b> Jaw width Anchura de la boca Largeur de mors Larghezza della bocca		<b>aufgewinkelt</b> angled upward acodado arrib angulé vers le haut angolato verso l'alto
	1/1	
	L	<b>7,5 cm</b>
<b>3 mm</b>		36-461-17-07

## Ohr-Knochenstanzen

Mastoid Rongeurs  
 Pinzas cortantes para huesos  
 Ostéotomes emporte-pièces  
 Pinze osteotomi

## Otologie

Otology  
 Otología  
 Otologie  
 Otologia

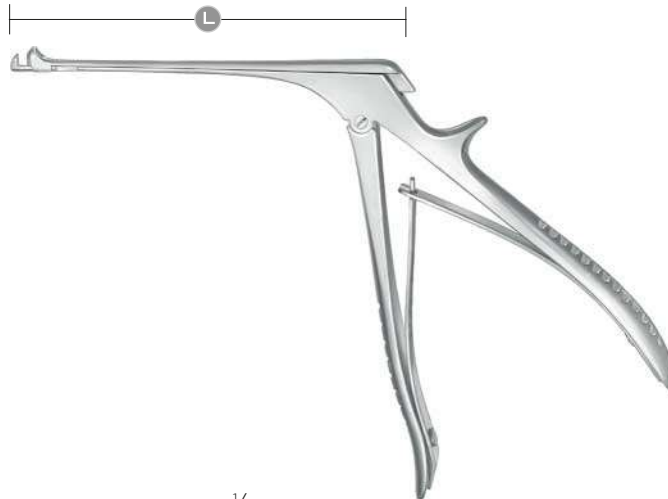
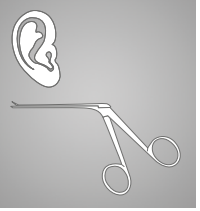

1/2

Beyer  
 36-463-19-07 -  
 36-466-14-07

36

<b>Maulbreite</b> <b>Jaw width</b> <b>Anchura de la boca</b> <b>Largeur de mors</b> <b>Larghezza della bocca</b>		<b>aufgewinkelt</b> <b>angled upward</b> <b>acodado arrib</b> <b>angulé vers le haut</b> <b>angolato verso l'alto</b>
	1/1	
	L	<b>9,5 cm</b>
1 mm		36-466-14-07
2 mm		36-463-19-07

# Ohrküretten

Ear Curettes  
Curetas auriculares  
Curettes auriculaires  
Curette auricolari

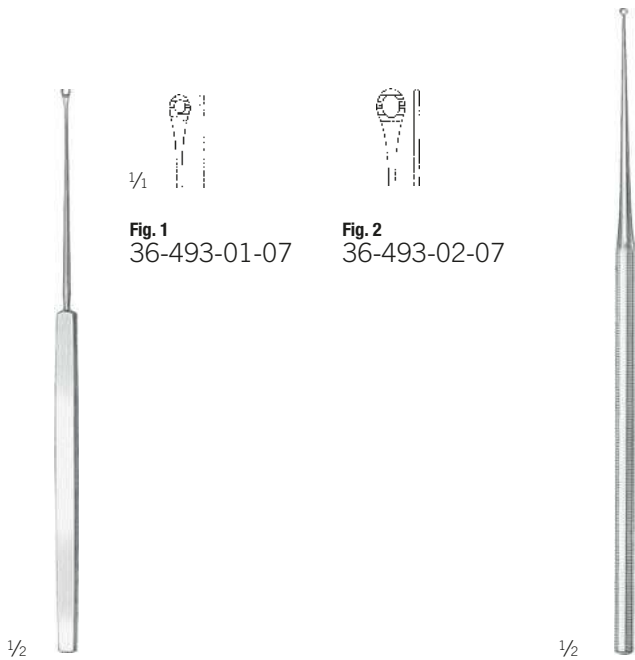

**Fig. 1**  
36-493-01-07

**Fig. 2**  
36-493-02-07

Shapleigh  
36-493-01-07 -  
36-493-02-07  
15 cm / 5 7/8"

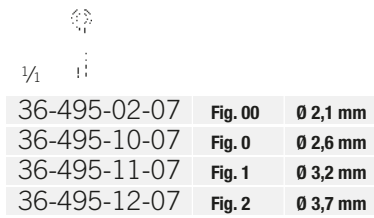

36-495-02-07	<b>Fig. 00</b>	<b>Ø 2,1 mm</b>
36-495-10-07	<b>Fig. 0</b>	<b>Ø 2,6 mm</b>
36-495-11-07	<b>Fig. 1</b>	<b>Ø 3,2 mm</b>
36-495-12-07	<b>Fig. 2</b>	<b>Ø 3,7 mm</b>

Buck  
36-495-02-07 -  
36-495-12-07  
17 cm / 6 5/8"  
stumpf  
blunt  
romo  
mousse  
smusso



Buck  
36-497-01-07 -  
36-498-14-07  
15 cm / 6 5/8"

stumpf blunt romo mousse smusso		
36-497-01-07	<b>Fig. 000</b>	<b>Ø 1,8 mm</b>
36-497-02-07	<b>Fig. 00</b>	<b>Ø 2,1 mm</b>
36-497-10-07	<b>Fig. 0</b>	<b>Ø 2,6 mm</b>
36-497-11-07	<b>Fig. 1</b>	<b>Ø 3,2 mm</b>
36-497-12-07	<b>Fig. 2</b>	<b>Ø 3,7 mm</b>
36-497-13-07	<b>Fig. 3</b>	<b>Ø 4,1 mm</b>
36-497-14-07	<b>Fig. 4</b>	<b>Ø 4,4 mm</b>

scharf sharp agudo pointu acuto		
36-498-01-07	<b>Fig. 000</b>	<b>Ø 1,8 mm</b>
36-498-02-07	<b>Fig. 00</b>	<b>Ø 2,1 mm</b>
36-498-10-07	<b>Fig. 0</b>	<b>Ø 2,6 mm</b>
36-498-11-07	<b>Fig. 1</b>	<b>Ø 3,2 mm</b>
36-498-12-07	<b>Fig. 2</b>	<b>Ø 3,7 mm</b>
36-498-13-07	<b>Fig. 3</b>	<b>Ø 4,1 mm</b>
36-498-14-07	<b>Fig. 4</b>	<b>Ø 4,4 mm</b>

# Ohrlöffel, Fremdkörperinstrumente

Ear Scoop, Foreign Body Instruments

Cucharilla auricular, Instrumentos para cuerpos extraños

Curette auriculaire, Instruments pour corps étrangers

Curetta auricolare, Strumenti per corpi estranei

# Otologie

Otology

Otología

Otologie

Otologia

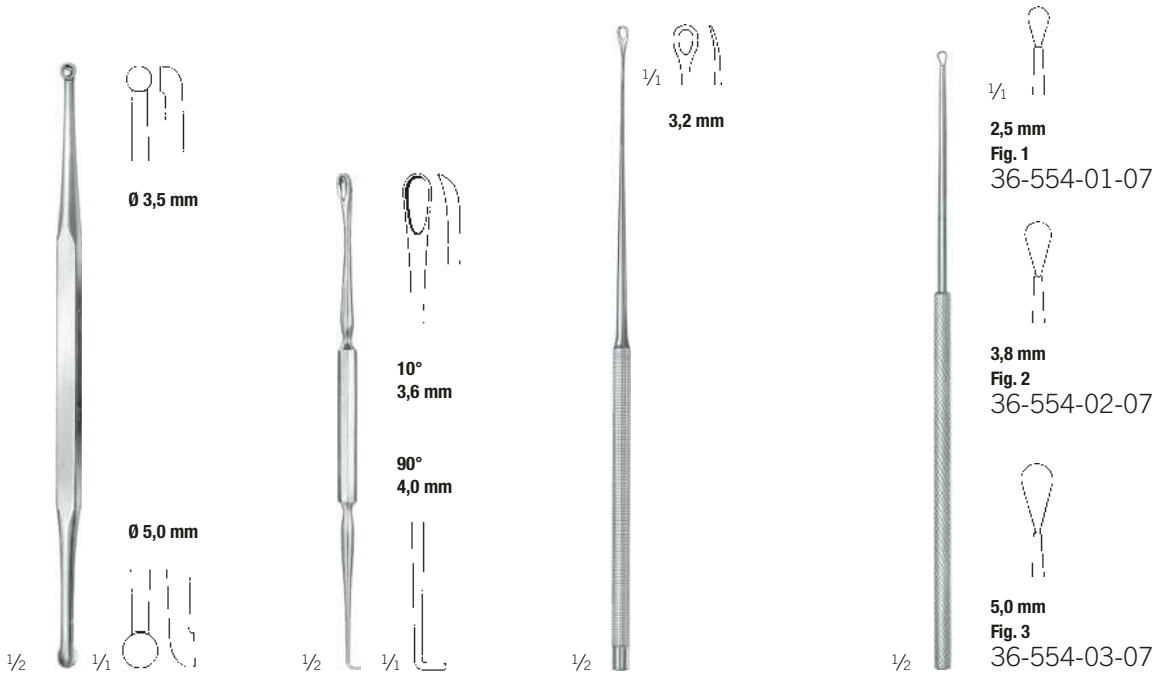
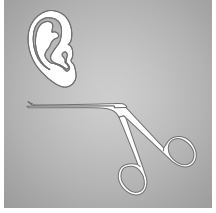

**Jansen**  
36-532-15-07  
16 cm / 6 2/8"  
scharf  
sharp  
agudo  
pointu  
acuto

**Gross**  
36-543-12-07  
13 cm / 5 1/8"  
stumpf  
blunt  
romo  
mousse  
smusso

**Weber-Loch**  
36-551-01-07  
17 cm / 6 5/8"  
stumpf  
blunt  
romo  
mousse  
smusso

**Billeau**  
36-554-01-07 -  
36-554-03-07  
16,5 cm / 6 1/8"

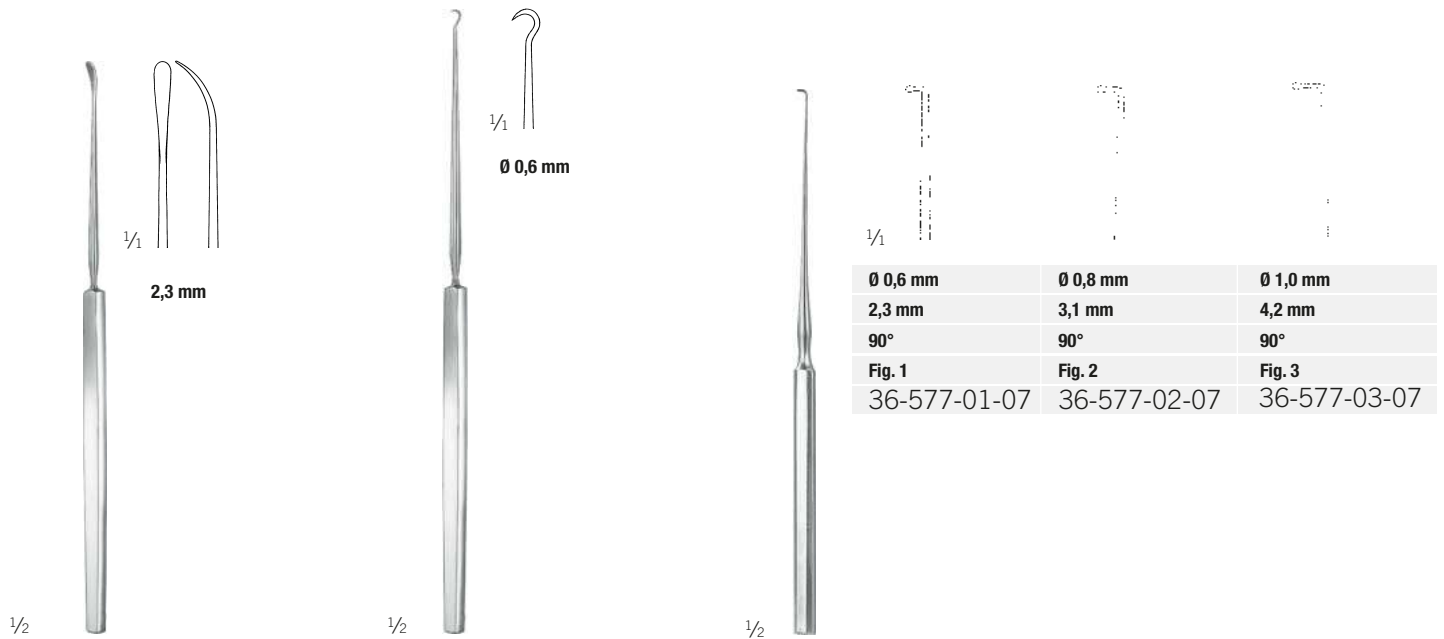

**Zaufal**  
36-563-16-07  
15 cm / 5 7/8"  
Fremdkörperhebel  
Foreign Body Lever  
Elevador para cuerpos extraños  
Anse auriculaire  
Leva per corpi estranei

**Hartmann**  
36-570-16-07  
16 cm / 6 2/8"  
Ohrhäkchen  
Ear Hooklet  
Ganchito auricular  
Levier pour corps étrangers  
Uncino auricolare

**Lucae**  
36-577-01-07 -  
36-577-03-07  
14 cm / 5 4/8"

Ø 0,6 mm	Ø 0,8 mm	Ø 1,0 mm
2,3 mm	3,1 mm	4,2 mm
90°	90°	90°
Fig. 1	Fig. 2	Fig. 3
36-577-01-07	36-577-02-07	36-577-03-07

# Ohrhäkchen, Trommelfellnadeln

Ear Hooklet, Tympanum Needles

Ganchito auricular, Agujas para tímpano

Levier pour corps étrangers, Instruments pour corps étrangers

Uncino auricolare, Strumenti per corpi estranei

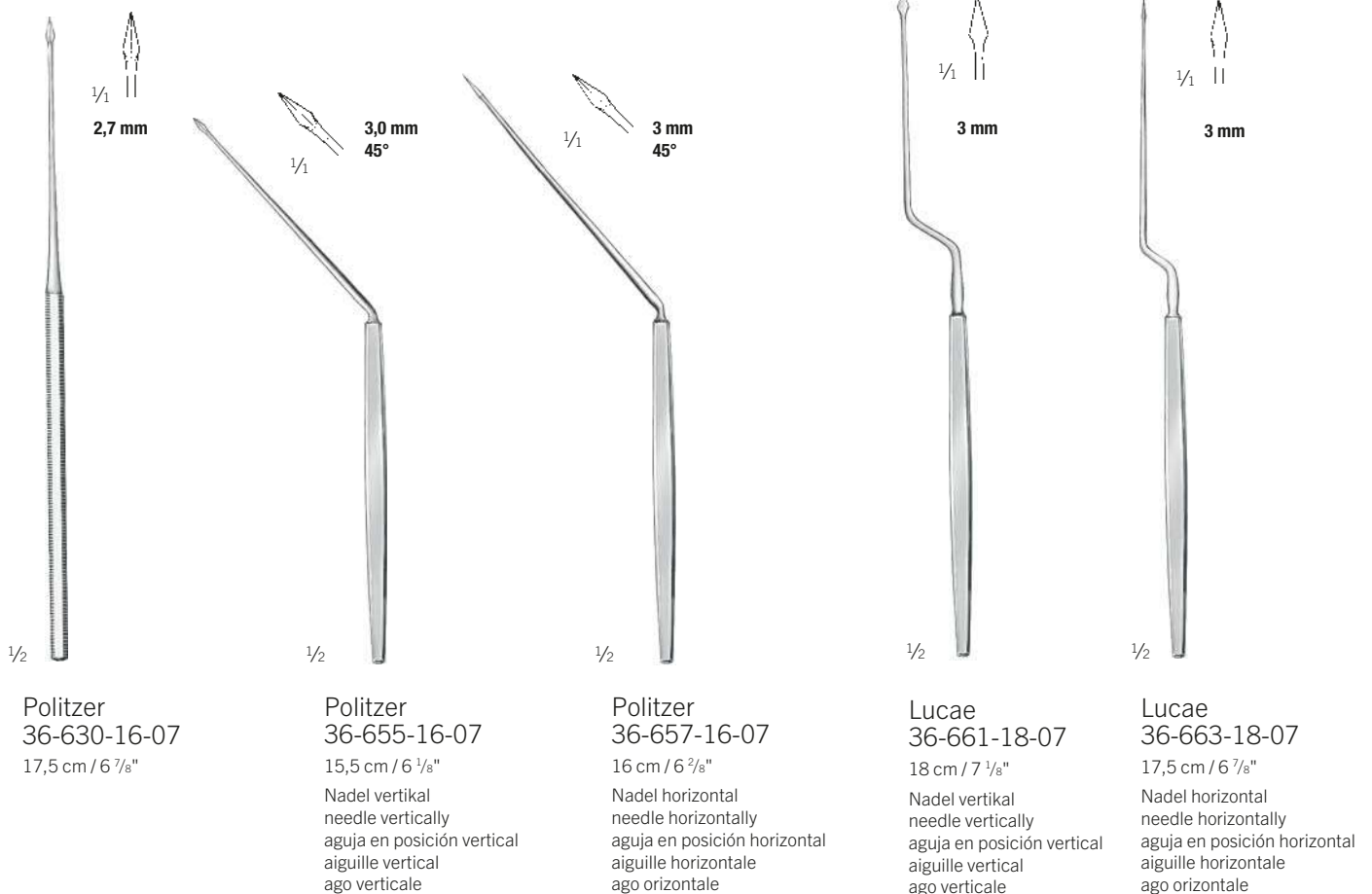



## Nasenspekula

Nasal Specula  
Espéculos nasales  
Spéculums nasaux  
Specoli nasali



1/2

Goldsmith (Thudichum)

36-817-01-01 -

36-817-03-01

6,5 cm / 2 1/8"

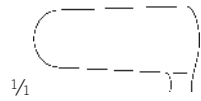

1/1

**Fig. 1**  
36-817-01-01

Blätter  
blades  
hojas  
lames  
lame

**18,5 x 9,5 mm**

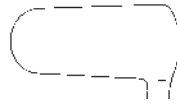

**Fig. 2**  
36-817-02-01

Blätter  
blades  
hojas  
lames  
lame

**21 x 10,5 mm**

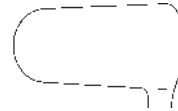

**Fig. 3**  
36-817-03-01

Blätter  
blades  
hojas  
lames  
lame

**21 x 11,5 mm**



1/2

Hartmann-Halle

36-845-01-07 -

36-845-03-07

16 cm / 6 2/8"

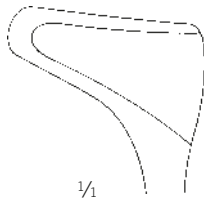

1/1

**Fig. 1**  
36-845-01-07

Blätter  
blades  
hojas  
lames  
lame

**27 mm**

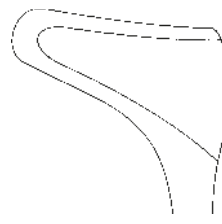

**Fig. 2**  
36-845-02-07

Blätter  
blades  
hojas  
lames  
lame

**31 mm**

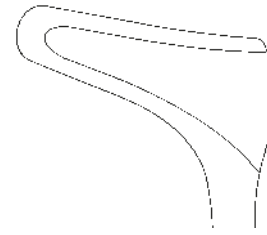

**Fig. 3**  
36-845-03-07

Blätter  
blades  
hojas  
lames  
lame

**35 mm**

# Nasenspekula

Nasal Specula  
Espéculos nasales  
Spéculums nasaux  
Specoli nasali

# Otologie

Otology  
Otología  
Otologie  
Otologie



1/1  
Blätter  
blades  
hojas  
lames  
lame  
**17 mm**

Martin  
36-848-13-07  
13 cm / 5 1/8"



1/1  
Blätter  
blades  
hojas  
lames  
lame  
**17 mm**

Martin  
36-849-13-07  
13 cm / 5 1/8"



1/1  
Blätter  
blades  
hojas  
lames  
lame  
**16 mm**

Tieck-Halle  
36-852-13-07  
13 cm / 5 1/8"



1/2  
Killian  
36-856-01-07 -  
36-856-04-07

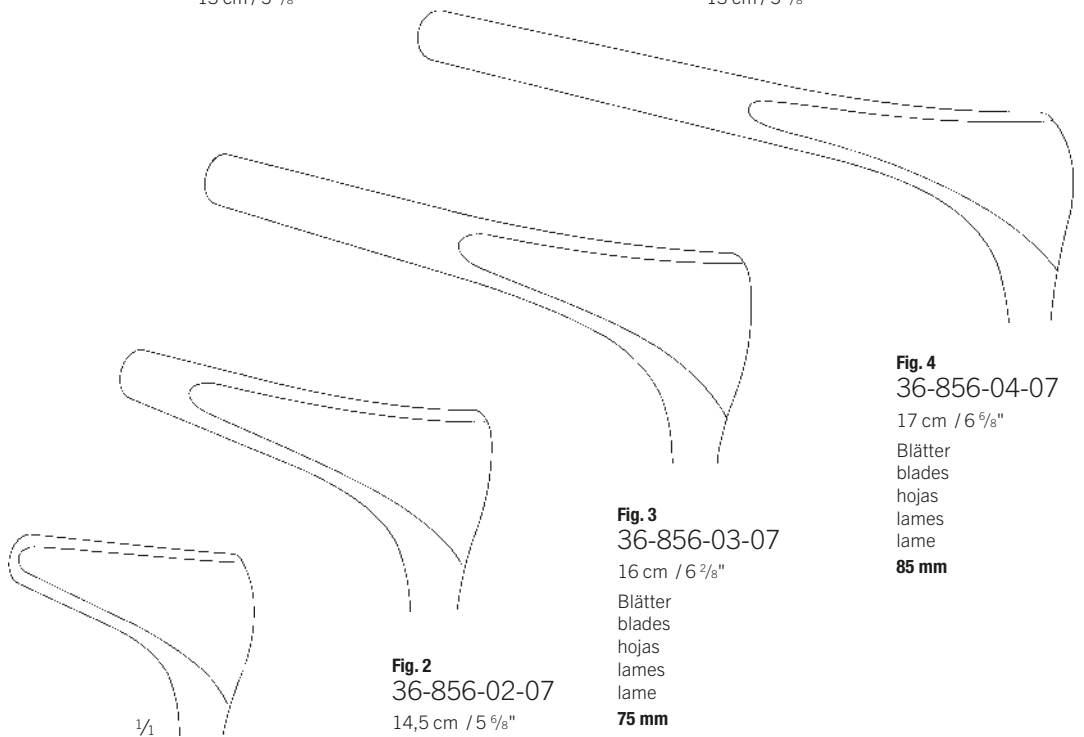

**Fig. 1**  
36-856-01-07  
14 cm / 5 4/8"  
Blätter  
blades  
hojas  
lames  
lame  
**35 mm**

**Fig. 2**  
36-856-02-07  
14,5 cm / 5 6/8"  
Blätter  
blades  
hojas  
lames  
lame  
**50 mm**

**Fig. 3**  
36-856-03-07  
16 cm / 6 2/8"  
Blätter  
blades  
hojas  
lames  
lame  
**75 mm**

**Fig. 4**  
36-856-04-07  
17 cm / 6 6/8"  
Blätter  
blades  
hojas  
lames  
lame  
**85 mm**

# Nasenspekula

Nasal Specula  
 Espéculos nasales  
 Spéculums nasaux  
 Specoli nasali



1/2

Mod. Wien  
 36-858-14-07  
 13,5 cm / 5 3/8"

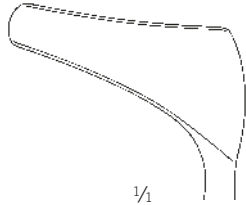

1/1  
 Blätter  
 blades  
 hojas  
 lames  
 lame  
**30 mm**



1/2

Cottle  
 36-859-35-07 -  
 36-859-90-07

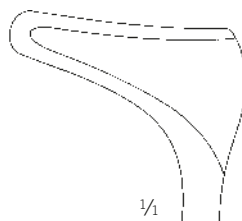

**Fig. 1**  
 36-859-35-07  
 13,5 cm / 5 3/8"  
 Blätter  
 blades  
 hojas  
 lames  
 lame  
**35 mm**

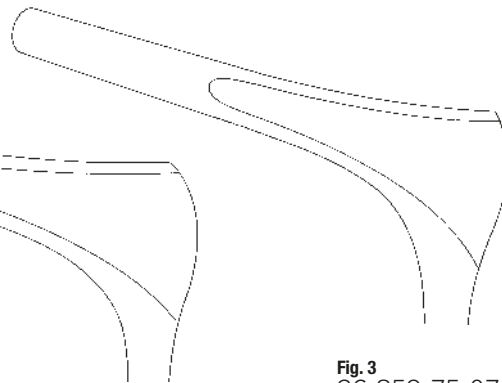

**Fig. 2**  
 36-859-50-07  
 14 cm / 5 4/8"  
 Blätter  
 blades  
 hojas  
 lames  
 lame  
**50 mm**

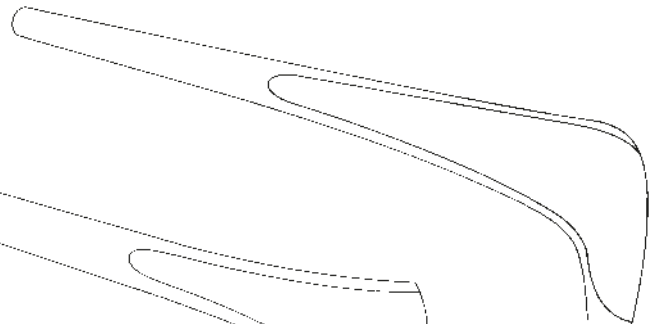

**Fig. 3**  
 36-859-75-07  
 16 cm / 6 2/8"  
 Blätter  
 blades  
 hojas  
 lames  
 lame  
**75 mm**

**Fig. 4**  
 36-859-90-07  
 16 cm / 6 2/8"  
 Blätter  
 blades  
 hojas  
 lames  
 lame  
**85 mm**

## Nasenspekula

Nasal Specula  
Espéculos nasales  
Spéculums nasaux  
Specoli nasali

## Otologie

Otology  
Otología  
Otologie  
Otologia

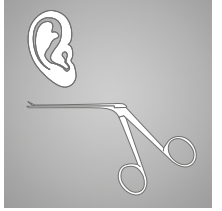

36

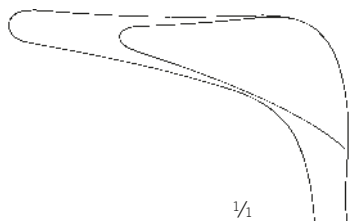

1/1

36-861-45-07

14 cm / 5 4/8"

Blätter  
blades  
hojas  
lames  
lame

45 mm

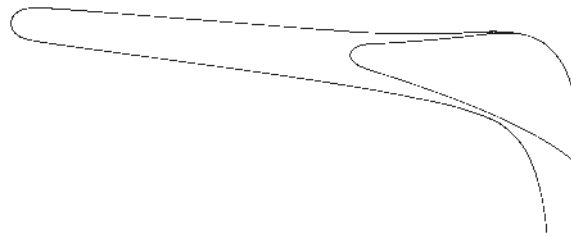

36-861-75-07

15,5 cm / 6 1/8"

Blätter  
blades  
hojas  
lames  
lame

75 mm



1/2

Cottle

36-861-45-07 -  
36-861-75-07

## Polypenschnürer

Polypus Snares

Polipótomos

Serre-noeuds pour polypes

Serranodi per polipi

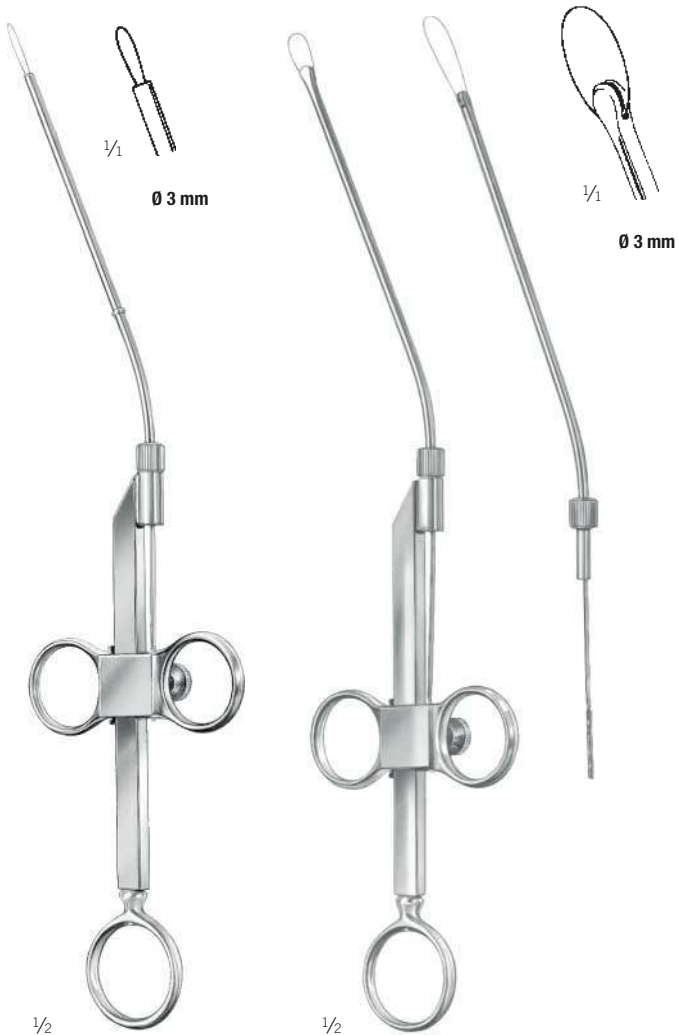

Krause  
36-885-26-07

26 cm / 10 <sup>2</sup>/<sub>8</sub>"

Schaft  
shaft  
vástago  
tige  
asta

Krause-Voss  
36-887-26-07

26 cm / 10 <sup>2</sup>/<sub>8</sub>"

Schaft  
shaft  
vástago  
tige  
asta

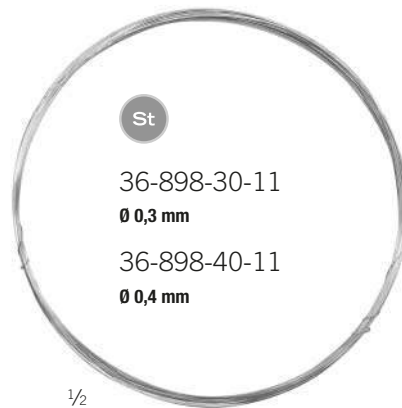

St

36-898-30-11

Ø 0,3 mm

36-898-40-11

Ø 0,4 mm

1/2



St

36-899-12-01

10,5 cm / 4"

Schnürdraht  
Snare Wire  
Asas de alambre  
Anses en fil d'acier  
Filo per allacciare  
Ø 0,3 mm

Bündel mit 12 Stück  
bundle with 12 pieces  
12 piezas atados  
paquet de 12 pièces  
confezione di 12 pezzi

1/2