

Gynäkologie
Gynecology
Ginecología
Gynécologie
Ginecologia

32

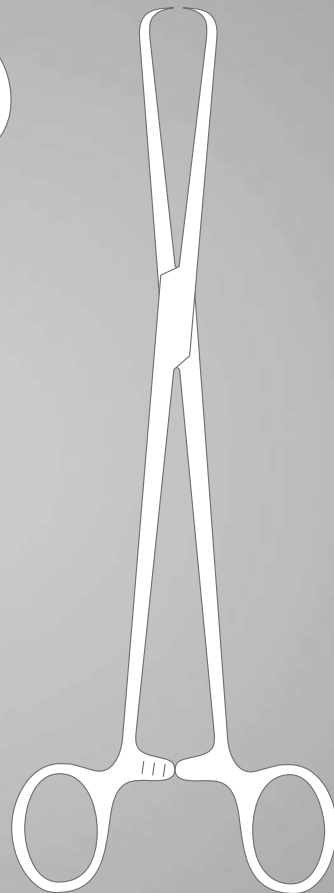
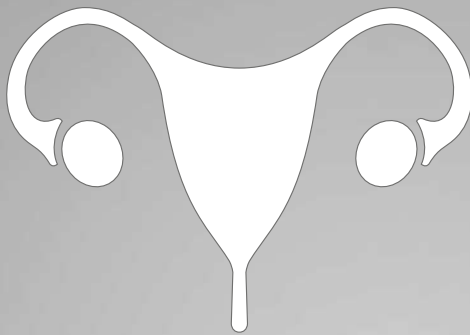

Vaginalspekula

Vaginal Specula
Espéculos vaginales
Spéculums vaginaux
Specoli vaginali



1/2

Cusco

32-110-01-01	75 x 32 mm
32-110-02-01	85 x 37 mm
32-110-03-01	100 x 35 mm



1/2

Cusco

32-112-01-01	75 x 18 mm
--------------	------------



1/2

Cusco

32-114-01-01	90 x 22 mm
32-114-02-01	100 x 25 mm
32-114-03-01	105 x 27 mm



1/2

Cusco

32-116-01-01	75 x 34 mm
32-116-02-01	85 x 37 mm
32-116-03-01	100 x 37 mm



1/2

Collin

32-120-01-01	85 x 30 mm
32-120-02-01	100 x 35 mm
32-120-03-01	110 x 40 mm

Vaginalspekula

Vaginal Specula
Espéculos vaginales
Spéculums vaginaux
Specoli vaginali

Gynäkologie

Gynecology
Ginecología
Gynécologie
Ginecologia

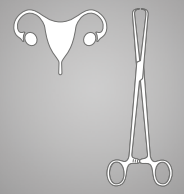

32



1/2

Pederson

32-128-01-01	75 x 13 mm
32-128-02-01	100 x 24 mm
32-128-03-01	120 x 26 mm



1/2

Grave

32-130-01-01	75 x 20 mm
32-130-02-01	95 x 35 mm
32-130-03-01	115 x 35 mm



1/2

Semm

32-132-01-01	100 x 20-25 mm
32-132-02-01	100 x 27-35 mm



1/2

Guttman

32-133-01-07	90 x 35 mm
--------------	------------

Vaginalspekula, Scheidenhalter

Vaginal Specula, Vaginal Retractors

Espéculos vaginales, Valvas vaginales

Spéculum vaginaux, Valves vaginales

Specoli vaginali, Valve vaginali



1/2

Sims

32-160-01-01	65 x 25 mm / 70 x 30 mm
32-160-02-01	70 x 30 mm / 80 x 35 mm
32-160-03-01	85 x 35 mm / 90 x 40 mm



1/2

Jackson

32-165-01-07	75 x 38 mm
32-165-02-07	90 x 38 mm
32-165-03-07	100 x 38 mm

Vaginalspekula, Scheidenhalter

Vaginal Specula, Vaginal Retractors
Espéculos vaginales, Valvas vaginales
Spéculums vaginaux, Valves vaginales
Specoli vaginali, Valve vaginali

Gynäkologie

Gynecology
Ginecología
Gynécologie
Ginecologia

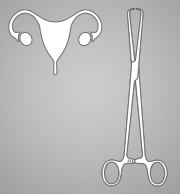

1/2

Kristeller

32-182-01-01	Fig. 1	70 x 27 mm
32-182-02-01	Fig. 2	80 x 30 mm
32-182-03-01	Fig. 3	90 x 36 mm



1/2

Kristeller

32-183-01-01	Fig. 1	75 x 23 mm
32-183-02-01	Fig. 2	85 x 26 mm
32-183-03-01	Fig. 3	100 x 32 mm



1/2

Kristeller

32-185-01-01	Fig. 1	(32-182-01-01 & 32-183-01-01)
32-185-02-01	Fig. 2	(32-182-02-01 & 32-183-02-01)
32-185-03-01	Fig. 3	(32-182-03-01 & 32-183-03-01)

Vaginalspekula, Scheidenhalter

Vaginal Specula, Vaginal Retractors

Espéculos vaginales, Valvas vaginales

Spéculums vaginaux, Valves vaginales

Specoli vaginali, Valve vaginali



½

Kristeller

32-190-01-01	Fig. 1	105 x 18 mm
32-190-02-01	Fig. 2	105 x 21 mm



½

Kristeller

32-191-01-01	Fig. 1	110 x 14 mm
32-191-02-01	Fig. 2	110 x 17 mm



½

Kristeller

32-195-01-01	Fig. 1	(32-190-01-01 & 32-191-01-01)
32-195-02-01	Fig. 2	(32-190-02-01 & 32-191-02-01)

Vaginalspekula, Scheidenhalter

Vaginal Specula, Vaginal Retractors
 Espéculos vaginales, Valvas vaginales
 Spéculums vaginaux, Valves vaginales
 Specoli vaginali, Valve vaginali

Gynäkologie

Gynecology
 Ginecología
 Gynécologie
 Ginecologia

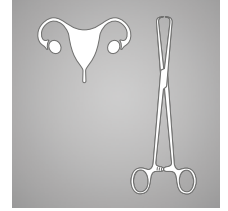

flaches Spekulum
 flat speculum
 espéculo plano
 spéculum plat
 specolo piatto



1/2

Kristeller

32-196-01-01	Fig. 1	105 x 26 mm
32-196-02-01	Fig. 2	105 x 28 mm
32-196-03-01	Fig. 3	105 x 33 mm



1/2

Kristeller

32-197-01-01	Fig. 1	115 x 22 mm
32-197-02-01	Fig. 2	115 x 24 mm
32-197-03-01	Fig. 3	115 x 29 mm



1/2

Kristeller

32-199-01-01	Fig. 1	(32-196-01-01 & 32-197-01-01)
32-199-02-01	Fig. 2	(32-196-02-01 & 32-197-02-01)
32-199-03-01	Fig. 3	(32-196-03-01 & 32-197-03-01)

Vaginalspekula, Scheidenhalter

Vaginal Specula, Vaginal Retractors

Espéculos vaginales, Valvas vaginales

Spéculums vaginaux, Valves vaginales

Specoli vaginali, Valve vaginali

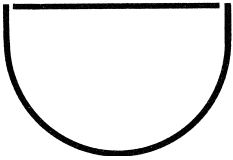

tiefes Spekulum
deep speculum
espéculo profundo
spéculum profond
specolo profondo



1/2

Kristeller

32-202-01-01	Fig. 1	110 x 28 mm
32-202-02-01	Fig. 2	110 x 30 mm
32-202-03-01	Fig. 3	110 x 36 mm



1/2

Kristeller

32-203-01-01	Fig. 1	115 x 23 mm
32-203-02-01	Fig. 2	115 x 26 mm
32-203-03-01	Fig. 3	115 x 32 mm



1/2

Kristeller

32-205-01-01	Fig. 1	(32-202-01-01 & 32-203-01-01)
32-205-02-01	Fig. 2	(32-202-02-01 & 32-203-02-01)
32-205-03-01	Fig. 3	(32-202-03-01 & 32-203-03-01)

Vaginalspekula, Scheidenhalter

Vaginal Specula, Vaginal Retractors
Espéculos vaginales, Valvas vaginales
Spéculums vaginaux, Valves vaginales
Specoli vaginali, Valve vaginali

Gynäkologie

Gynecology
Ginecología
Gynécologie
Ginecologia

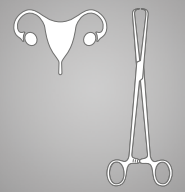

1/2

Kallmorgen

32-232-01-01	Fig. 1	70 x 40 mm
32-232-02-01	Fig. 2	90 x 40 mm



1/2

Kallmorgen

32-233-01-01	Fig. 1	70 x 37 mm
32-233-02-01	Fig. 2	90 x 37 mm



1/2

Kallmorgen

32-235-01-01	Fig. 1	(32-232-01-01 & 32-233-01-01)
32-235-02-01	Fig. 2	(32-232-02-01 & 32-233-02-01)

Vaginalspekula, Scheidenhalter

Vaginal Specula, Vaginal Retractors

Espéculos vaginales, Valvas vaginales

Spéculum vaginaux, Valves vaginales

Specoli vaginali, Valve vaginali



1/2

Doyen

32-249-01-01	58 x 35 mm
32-249-02-01	88 x 35 mm
32-249-03-01	118 x 35 mm

32-250-01-01	60 x 47 mm
32-250-02-01	95 x 47 mm
32-250-03-01	120 x 47 mm
32-250-04-01	165 x 47 mm

32-251-01-01	55 x 60 mm
32-251-02-01	85 x 60 mm
32-251-03-01	115 x 60 mm

32-252-01-01	160 x 60 mm
32-252-02-01	200 x 60 mm

Vaginalspekula, Scheidenhalter

Vaginal Specula, Vaginal Retractors
Espéculos vaginales, Valvas vaginales
Spéculums vaginaux, Valves vaginales
Specoli vaginali, Valve vaginali

Gynäkologie

Gynecology
Ginecología
Gynécologie
Ginecologia

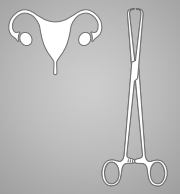

Scherbak

Blatt, allein
Specula Blade, only
Valva vaginal, suelta
Valve vaginale, seule
Valve vaginale, sola

1/1

80 x 30 mm
32-302-01-01

➔ 32-302-14-07

85 x 35 mm
32-302-02-01

➔ 32-302-14-07

90 x 40 mm
32-302-03-01

➔ 32-302-14-07

32



Scherbak

Blatt, allein
Specula Blade, only
Valva vaginal, suelta
Valve vaginale, seule
Valve vaginale, sola

58 x 40 - 60 mm
32-302-04-01

➔ 32-302-14-07

70 x 45 - 70 mm
32-302-05-01

➔ 32-302-14-07

➔ Handgriff siehe Seite 610
Handle see page 610
Mango consulte la página 610
Manche voir page 610
Manico vedi pagina 610

Vaginalspekula

Vaginal Specula
Espéculos vaginales
Spéculums vaginaux
Specoli vaginali

Scherbak

32-302-00-01

Satz komplett mit Griff, Gewicht (400 g) und 5 Blättern
complete set with handle, weight (400 g) and 5 blades
juego completo con mango, peso (400 g) y 5 valvas
jeu complet avec manche, poids (400 g) et 5 valves
Set completo con manico, peso (400 g) e 5 valve



Blätter siehe Seite 609
Blades see page 609
Valve consulte la página 609
Valves voir page 609
Valvi vedi pagina 609



1/2

Scherbak

32-302-14-07

20 cm / 7 7/8"

Griff zum Vaginalspekulum
Handle for Vaginal Speculum
Mango para espéculo vaginal
Manche pour spéculum vaginal
Manico per specolo vaginale



1/3

Scherbak

32-302-12-01

13 cm / 5" / 800 g

Gewicht zum Vaginalspekulum
Weight for Vaginal Speculum
Peso para espéculo vaginal
Poids pour spéculum vaginal
Peso per specolo vaginale



1/3

Scherbak

32-302-10-01

10,5 cm / 4" / 400 g

Gewicht zum Vaginalspekulum
Weight for Vaginal Speculum
Peso para espéculo vaginal
Poids pour spéculum vaginal
Peso per specolo vaginale

Vaginalspekula

Vaginal Specula
Espéculos vaginales
Spéculums vaginaux
Specoli vaginali

Gynäkologie

Gynecology
Ginecología
Gynécologie
Ginecologia

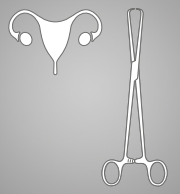

32



1/1

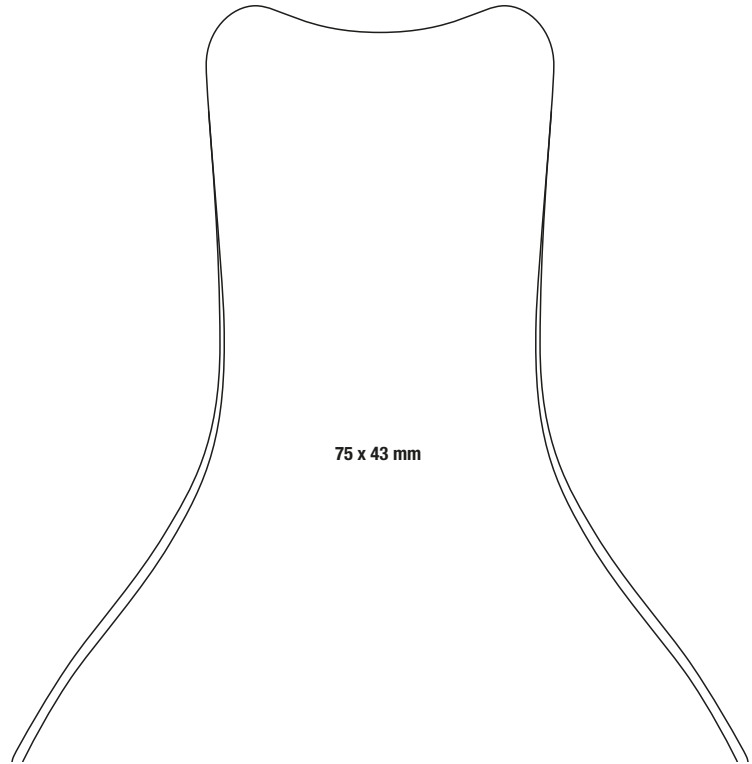

75 x 43 mm

32-310-90-98

Gewicht allein
Weight only
Peso suelta
Poids seul
Peso solo

1 Kg

1/2

Auvar
32-310-22-01
23,5 cm / 9 2/8"

komplett, mit abnehmbarem Gewicht
complete, with detachable weight
completo, con peso desmontable
complet, avec poids démontable
completo, con peso smontabile

Vaginalspekula, Scheidenhalter

Vaginal Specula, Vaginal Retractors

Espécules vaginales, Valvas vaginales

Spéculums vaginaux, Valves vaginales

Specoli vaginali, Valve vaginali



Weissbarth
32-314-24-02

21 cm / 8 2/8"

komplett, mit abnehmbarem Auffangsieb
complete, with detachable strainer
completo, con tamiz desmontable
complet, avec tamis démontable
completo, con crivello smontabile

32-314-99-02

Auffangsieb
Strainer for Vaginal Speculum
Tamiz para espéculo vaginal
Tamis pour spéculum vaginal
Crivello per specola vaginale



32-314-24-02



Breisky
32-323-20-07 -
32-325-40-07

32-323-20-07	100 x 20 mm	29,5 cm / 11 5/8"
32-323-25-07	100 x 25 mm	29,5 cm / 11 5/8"
32-323-30-07	100 x 30 mm	29,5 cm / 11 5/8"
32-323-35-07	100 x 35 mm	29,5 cm / 11 5/8"
32-323-40-07	100 x 40 mm	29,5 cm / 11 5/8"

32-324-20-07	130 x 20 mm	32 cm / 12 5/8"
32-324-25-07	130 x 25 mm	32 cm / 12 5/8"
32-324-30-07	130 x 30 mm	32 cm / 12 5/8"
32-324-35-07	130 x 35 mm	32 cm / 12 5/8"
32-324-40-07	130 x 40 mm	32 cm / 12 5/8"

32-325-40-07	160 x 40 mm	35 cm / 13 6/8"
--------------	-------------	-----------------



Doyen
32-342-24-01
25 cm / 9 7/8"

Endospekula

Endocervical Specula
Espéculos endocervicales
Endospéculums
Endospecoli

Gynäkologie

Gynecology
Ginecología
Gynécologie
Ginecologia

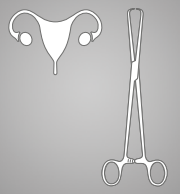

1/2

Kogan
32-381-24-07
24,5 cm / 9 5/8"



1/2

Kogan
32-383-24-07
24,5 cm / 9 5/8"

Uterusdilatatoren

Uterine Dilators
Dilatadores uterinos
Dilateurs du col de l'utérus
Dilatatori uterini

mm Ø		
1,0	32-400-01-01	
1,5		32-401-01-01
2,0	32-400-02-01	
2,5		32-401-02-01
3,0	32-400-03-01	
3,5		32-401-03-01
4,0	32-400-04-01	
4,5		32-401-04-01
5,0	32-400-05-01	
5,5		32-401-05-01
6,0	32-400-06-01	
6,5		32-401-06-01
7,0	32-400-07-01	
7,5		32-401-07-01
8,0	32-400-08-01	
8,5		32-401-08-01
9,0	32-400-09-01	
9,5		32-401-09-01
10,0	32-400-10-01	
10,5		32-401-10-01
11,0	32-400-11-01	
11,5		32-401-11-01
12,0	32-400-12-01	
12,5		32-401-12-01
13,0	32-400-13-01	
13,5		32-401-13-01
14,0	32-400-14-01	
14,5		32-401-14-01
15,0	32-400-15-01	
15,5		32-401-15-01
16,0	32-400-16-01	
16,5		32-401-16-01
17,0	32-400-17-01	
17,5		32-401-17-01
18,0	32-400-18-01	
19,0	32-400-19-01	
20,0	32-400-20-01	
21,0	32-400-21-01	
22,0	32-400-22-01	
23,0	32-400-23-01	
24,0	32-400-24-01	
25,0	32-400-25-01	
26,0	32-400-26-01	



1/2

Hegar
32-400-01-01 -
32-401-17-01
18,5 cm / 7 2/8"

32-400-80-01

Satz mit 14 Stück (ganze Größen) von 4,0 bis 17,0 mm **ohne Etui**
set of 14 pieces (full sizes) from 4,0 to 17,0 mm **without case**
juego de 14 piezas (tamaños enteros) de 4,0 a 17,0 mm **sin caja**
jeu de 14 pièces (taille entière) de 4,0 jusqu'à 17,0 mm **sans boîte**
serie di 14 pezzi (grandezza intera) da 4,0 fino a 17,0 mm **senza scatola**

32-400-90-01

Satz mit 26 Stück (ganze Größen) von 1,0 bis 26,0 mm **ohne Etui**
set of 26 pieces (full sizes) from 1,0 to 26,0 mm **without case**
juego de 26 piezas (tamaños enteros) de 1,0 a 26,0 mm **sin caja**
jeu de 26 pièces (taille entière) de 1,0 jusqu'à 26,0 mm **sans boîte**
serie di 26 pezzi (grandezza intera) da 1,0 fino a 26,0 mm **senza scatola**

Uterusdilatoren

Uterine Dilators
Dilatadores uterinos
Dilatateurs du col de l'utérus
Dilatatori uterini

Gynäkologie

Gynecology
Ginecología
Gynécologie
Ginecologia

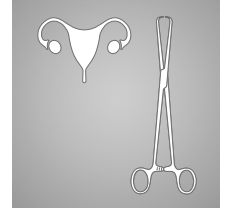

mm Ø	
1,0 / 2,0	32-430-02-01
3,0 / 4,0	32-430-04-01
5,0 / 6,0	32-430-06-01
7,0 / 8,0	32-430-08-01
9,0 / 10,0	32-430-10-01
11,0 / 12,0	32-430-12-01
13,0 / 14,0	32-430-14-01
15,0 / 16,0	32-430-16-01
17,0 / 18,0	32-430-18-01
19,0 / 20,0	32-430-20-01
21,0 / 22,0	32-430-22-01
23,0 / 24,0	32-430-24-01
25,0 / 26,0	32-430-26-01

1/2

Hegar
32-430-02-01 -
32-430-26-01
20 cm / 7 7/8"

32-430-80-01

Satz mit 8 Stück von 3,0 / 4,0 bis 17,0 / 18,0 mm **ohne Etui**
set of 8 pieces from 3,0 / 4,0 to 17,0 / 18,0 mm **without case**
juego de 8 piezas de 3,0 / 4,0 a 17,0 / 18,0 mm **sin caja**
jeu de 8 pièces de 3,0 / 4,0 jusqu'à 17,0 / 18,0 mm **sans boîte**
serie di 8 pezzi da 3,0 / 4,0 fino a 17,0 / 18,0 mm **senza scatola**

Uterusdilatoren

Uterine Dilators

Dilatadores uterinos

Dilatateurs du col de l'utérus

Dilatatori uterini



Hegar

32-430-82-01

Satz mit 8 Stück von 3,0 / 4,0 bis 17,0 / 18,0 mm in
auskochbarer Stoffrolltasche

set of 8 pieces from 3,0 / 4,0 to 17,0 / 18,0 mm
in boilable canvas roll

juego de 8 piezas de 3,0 / 4,0 a 17,0 / 18,0 mm en
bolsa de tela esterilizable por ebullición

jeu de 8 pièces de 3,0 / 4,0 jusqu'à 17,0 / 18,0 mm
en pochette en treillis stérilisable par ébullition

serie di 8 pezzi di 3,0 / 4,0 jusqu'à 17,0 / 18,0 mm
in busta di tela sterilizzabile

Uterusdilatoren

Uterine Dilators
Dilatadores uterinos
Dilatateurs du col de l'utérus
Dilatatori uterini

Gynäkologie

Gynecology
Ginecología
Gynécologie
Ginecologia

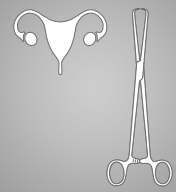

32



1/2

Hank

32-460-10-01 -
32-460-20-01

26,5 cm / 10 ³/₈"

amerikanische Skala
American scale
escala americana
échelle américaine
scala americana

	Fig.	mm Ø
32-460-10-01	9 / 10	4,5 / 5,0
32-460-12-01	11 / 12	5,5 / 6,0
32-460-14-01	13 / 14	6,5 / 7,0
32-460-16-01	15 / 16	7,5 / 8,0
32-460-18-01	17 / 18	8,5 / 9,0
32-460-20-01	19 / 20	9,5 / 10,0



Hank

32-460-82-01

Satz mit 6 Stück in auskochbarer
Stoffrolltasche

set of 6 piezas in boilable canvas roll

juego de 6 piezas en bolsa de tela
esterilizable por ebullición

jeu de 6 pièces en pochette en treillis
stérilisable par ébullition

serie di 6 pezzi in busta di tela
sterilizzabile

Uterussonden, Uterusdepressor

Uterine Sounds, Uterine Depressor

Histerómetros, Depresor uterino

Hystéromètres, Dépresseur utérin

Isterometri, Depressore uterino

Cr

Ø 4 mm



1/2

Sims
32-583-32-01
33 cm / 13"
starr
rigid
rigido
rigide
rigido

Ø 4 mm



1/2

Sims
32-584-32-02
33 cm / 13"
biegsam
malleable
maleable
malléable
malleabile

Ø 4 mm



1/2

Valleix
32-593-25-01
25,5 cm / 10"



1/2

Braun
32-595-26-07
27 cm / 10 5/8"

Hakenzangen, Amniotom

Uterine Tenaculum Forceps, Amniotome

Pinza para cuello uterino, Amniótomo

Pince pour le col de l'utérus, Amniotome

Pinza per il collo dell'utero, Amniotomo

Gynäkologie

Gynecology

Ginecología

Gynécologie

Ginecologia

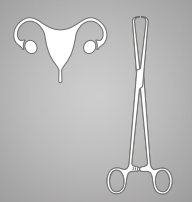

1/2

Schröder
32-622-25-07
25,5 cm / 10"



1/2

Braun
32-628-25-07
26 cm / 10 3/8"



1/2

Duplay
32-645-28-07
28 cm / 11"



1/2

Beacham
32-659-26-07
26 cm / 10 2/8"

Hakenzangen

Uterine Tenaculum Forceps

Pinza para cuello uterino

Pince pour le col de l'utérus

Pinza per il collo dell'utero

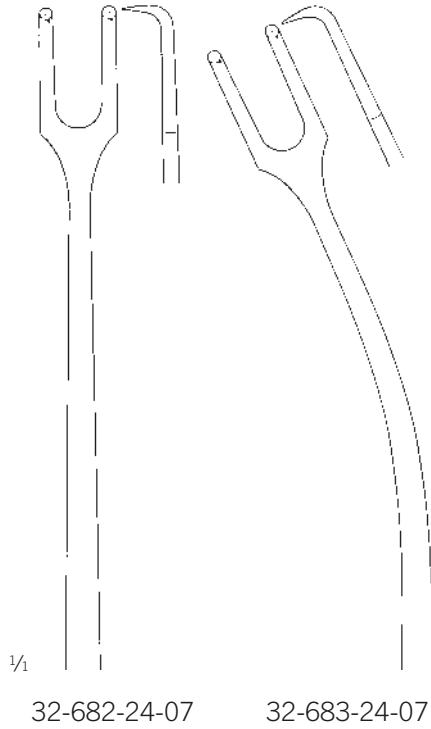

Skene
32-663-24-07
24 cm / 9 4/8"



Schröder
32-682-24-07 -
32-683-24-07
25 cm / 9 7/8"



Teale
32-697-23-07
23 cm / 9"



Hakenzangen

Uterine Tenaculum Forceps
Pinza para cuello uterino
Pince pour le col de l'utérus
Pinza per il collo dell'utero

Gynäkologie

Gynecology
Ginecología
Gynécologie
Ginecologia

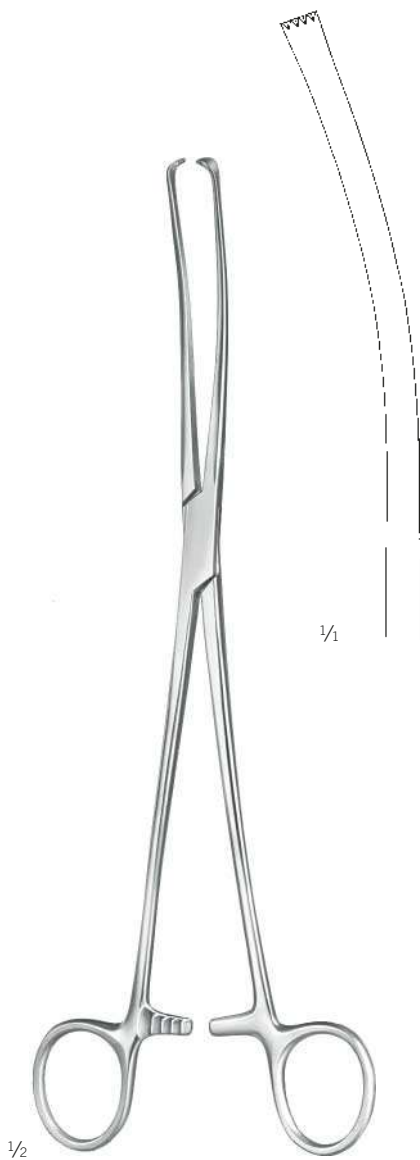
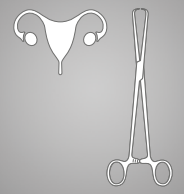

Iowa
32-699-26-07
26 cm / 10 2/8"



5:6



Museux
32-702-24-07 -
32-706-24-07
24 cm / 9 4/8"



2:2



Jacobs
32-728-21-07
21 cm / 8 2/8"



2:2

Hakenzangen

Uterine Tenaculum Forceps

Pinza para cuello uterino

Pince pour le col de l'utérus

Pinza per il collo dell'utero



32-734-26-07

26,5 cm / 10 ³/₈"



4:4

Braun
32-738-16-07

16 cm / 6 ²/₈"



4:4

Czerny
32-740-21-07

21 cm / 8 ²/₈"



4:4

Uterus-Polypenzangen

Uterine Polypus Forceps
Pinzas para pólipos uterinos
Pincas à polypes utérins
Pinze per polipi uterini

Gynäkologie

Gynecology
Ginecología
Gynécologie
Ginecologia

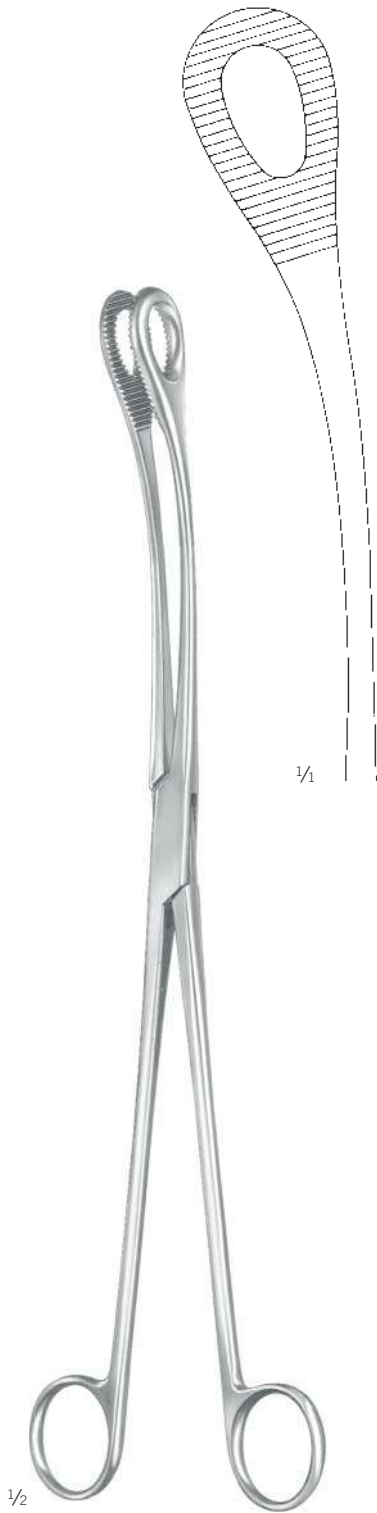
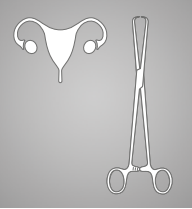

Kelly
32-741-32-07
31,5 cm / 12 3/8"

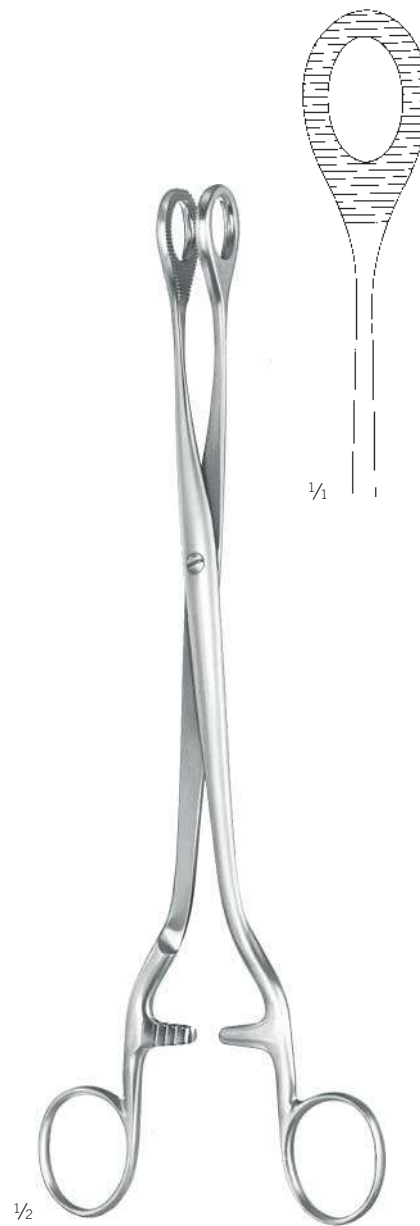

Noto
32-744-27-07
27 cm / 10 5/8"



Heywood-Smith
32-745-25-07
26 cm / 10 2/8"

Myomheber, Myommesser

Myoma Screws, Myoma Knife

Tirabuzones para fibroma, Cuchillo para fibroma

Tracteurs pour fibromes, Evideur de fibromes

Tiramiomi, Bisturi per fibromi



Doyen
32-758-17-07
17 cm / 6 5/8"



Doyen
32-760-17-07
15 cm / 5 7/8"

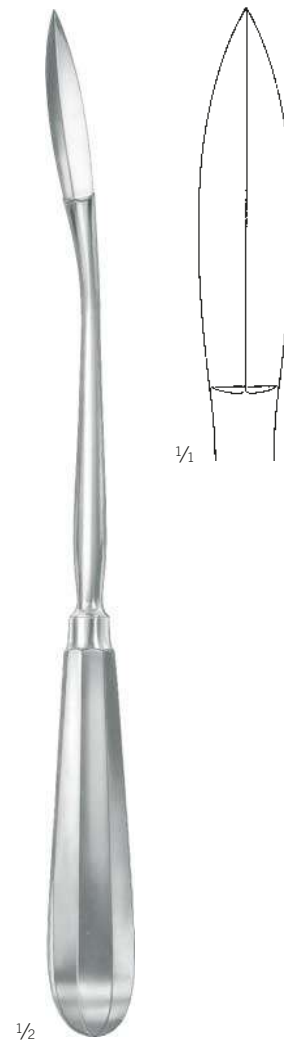

Segond
32-762-27-07
28 cm / 11 "

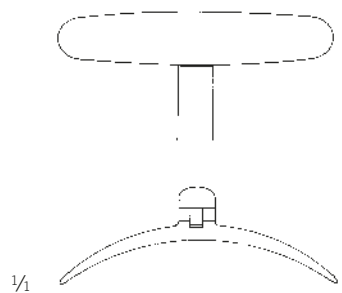
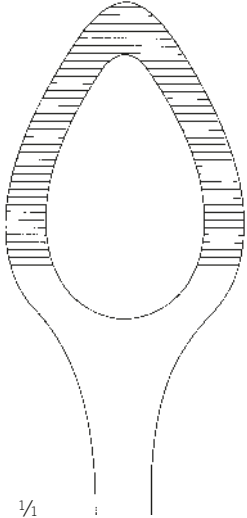
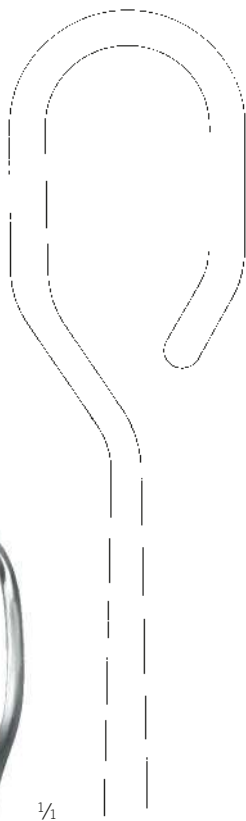
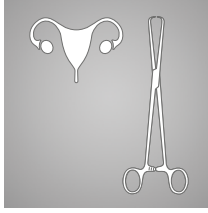

$\frac{1}{2}$
Dartigues
 32-773-27-07
 27 cm / 10 $\frac{5}{8}$ "

$\frac{1}{2}$
Somer
 32-779-23-07
 22,5 cm / 8 $\frac{7}{8}$ "

$\frac{1}{2}$
Collin
 32-793-25-07
 26 cm / 10 $\frac{2}{8}$ "

Fistelhaken

Fistula Hooks

Ganchos para fístulas

Crochets pour fistules

Uncini per fistole



Emmett
32-804-03-07
23 cm / 9 "



Simon
32-806-22-07
21,5 cm / 8 4/8 "

Saugküretten, Biopsieküretten

Suction Curettes

Curetas aspiradoras

Curettes à aspiration

Curette d'aspirazione

Gynäkologie

Gynecology

Ginecología

Gynécologie

Ginecologia

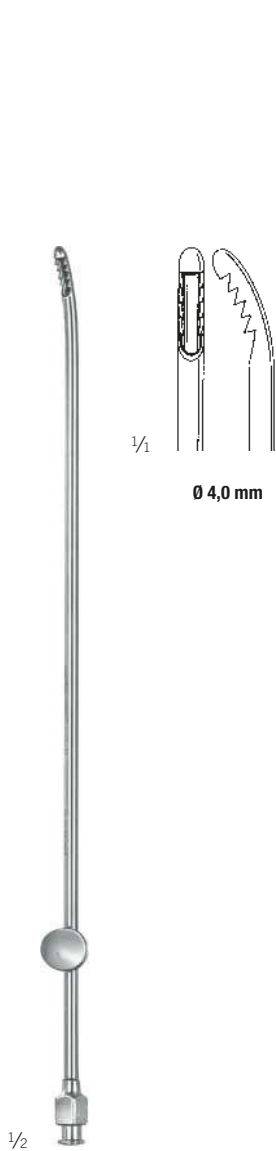
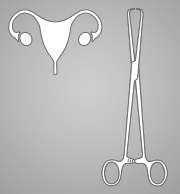

Novak
32-825-23-01
24,5 cm / 9 5/8"

mit Luer-Lock Ansatz
with Luer-Lock connection
con conexión Luer-Lock
avec connection Luer-Lock
con raccordo Luer-Lock



Kevorkian
32-827-30-07
30 cm / 11 5/8"



Mod. München
32-829-27-07
27 cm / 10 5/8"

Probeexzisionszangen

Uterine Biopsy Forceps

Pinzas para biopsia

Pinces pour biopsie

Pinze per biopsia



Gellhorn
32-841-23-07
24 cm / 9 4/8"



Faure
32-843-21-07
21 cm / 8 3/8"



Schubert
32-846-21-07 -
32-846-28-07

Probeexzisionszangen

Uterine Biopsy Forceps

Pinzas para biopsia

Pinces pour biopsie

Pinze per biopsia

Gynäkologie

Gynecology

Ginecología

Gynécologie

Ginecologia

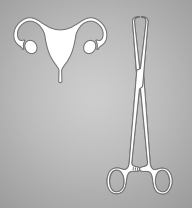

1/2

Thoms-Gaylor
32-851-22-07 -
32-851-24-07



1/1



Ø 5,6 mm
32-851-22-07
21 cm / 8 2/8"



Ø 5,6 mm
32-851-24-07
24 cm / 9 4/8"

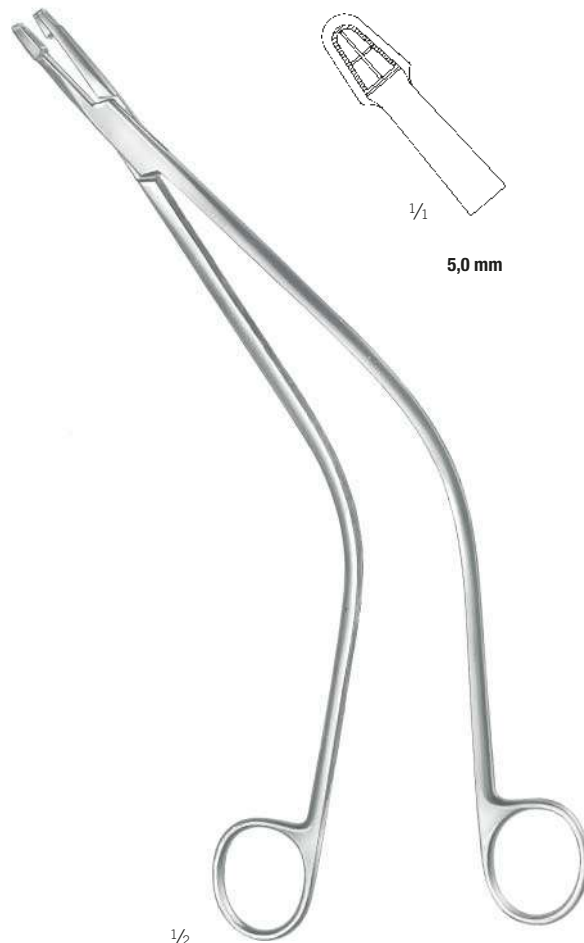

1/2

Schubert
32-853-26-07
24 cm / 9 4/8"

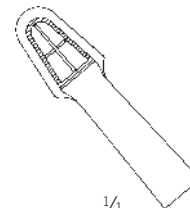

1/1

5,0 mm

Probeexzisionszangen

Uterine Biopsy Forceps

Pinzas para biopsia

Pinces pour biopsie

Pinze per biopsia



$\frac{1}{2}$

Van Doren
32-855-24-07
27 cm / 10 $\frac{5}{8}$ "



$\frac{1}{2}$

Van Doren
32-855-25-07
25,5 cm / 10 "

Probeexzisionszangen

Uterine Biopsy Forceps

Pinzas para biopsia

Pinces pour biopsie

Pinze per biopsia

Gynäkologie

Gynecology

Ginecología

Gynécologie

Ginecologia

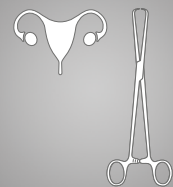

Alexander

32-857-28-07

retrograder Schnitt, Maul nach links gebogen, geeignet für Kolposkopie
retrograde cutting, jaws curved to left, suitable als in colposcopy
corte retrograde, boca curva hacia izquierda, utilizable en colposcopia
coupe retrograde, mors courbé vers gauche, approprié pour colposcopie
filo retrogrado, morso curvato verso, adatto per colposcopia

Schaftlänge
shaft length
longitud del vástago
longueur de la tige
lunghezza dell'asta

195 mm

Maul 5,1 mm breit
jaw 5,1 mm wide
boca 5,1 mm de ancho
mors largeur 5,1 mm
morso larghezza 5,1 mm

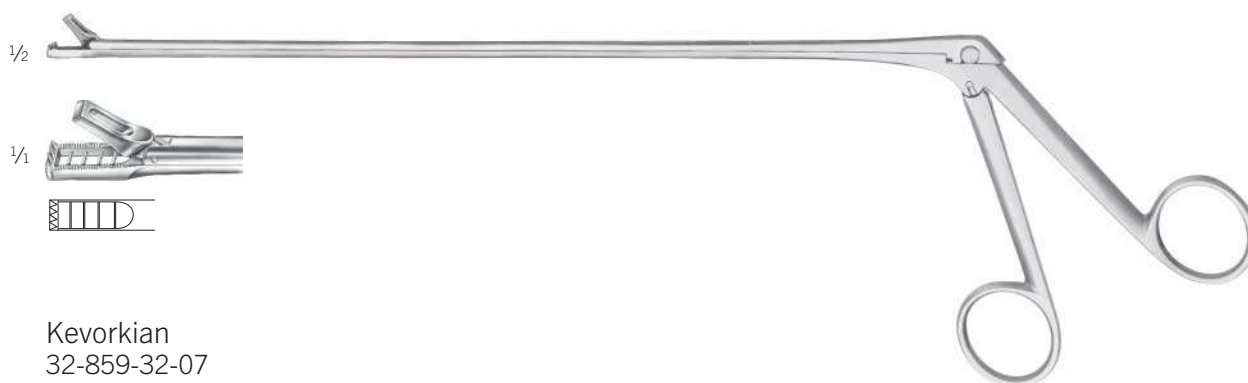

Kevorkian

32-859-32-07

Schaftlänge
shaft length
longitud del vástago
longueur de la tige
lunghezza dell'asta

250 mm

Maul 3 mm breit
jaw 3 mm wide
boca 3 mm de ancho
mors largeur 3 mm
morso larghezza 3 mm

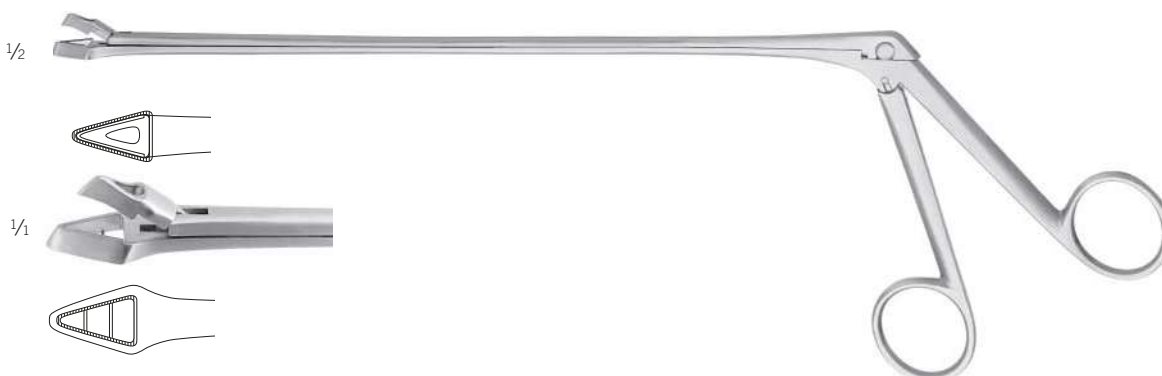

Schumacher

32-861-02-07

Schaftlänge
shaft length
longitud del vástago
longueur de la tige
lunghezza dell'asta

225 mm

Maul 5,4 mm breit
jaw 5,4 mm wide
boca 5,4 mm de ancho
mors largeur 5,4 mm
morso larghezza 5,4 mm

Probeexzisionszangen, IUP-Fasszangen

Uterine Biopsy Forceps, IUP Grasping Forceps

Pinzas para biopsia, Pinzas para coger DIU

Pinces pour biopsie, Pinces pour DIU

Pinze per biopsia, Pinze per DIU

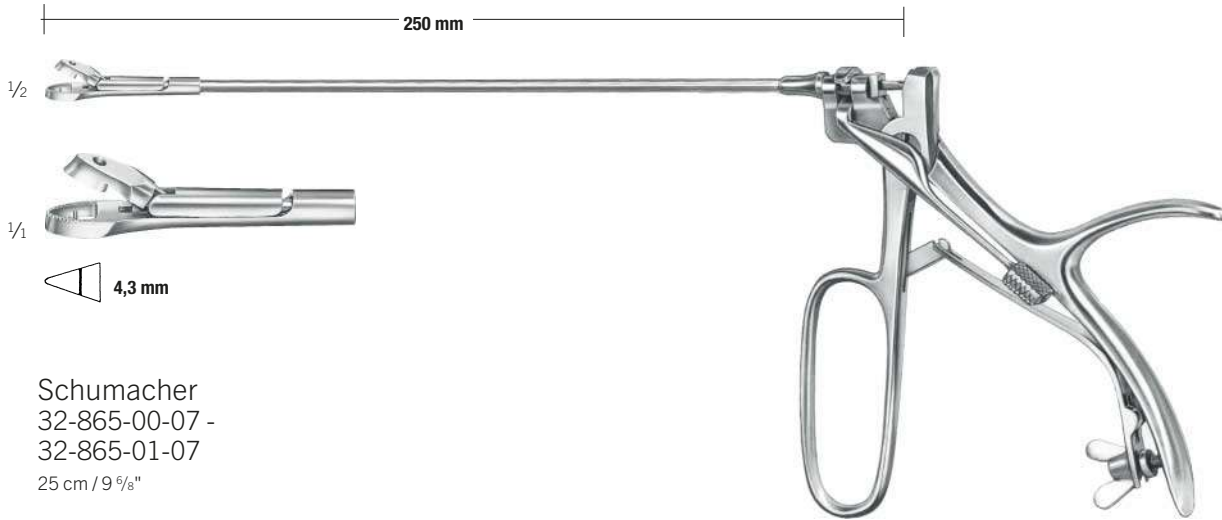

Schumacher
32-865-00-07 -
32-865-01-07
25 cm / 9 7/8"

32-865-00-07

Set, komplett, bestehend aus:
Set, complete, consisting of:
Juego, completo, formado por:
Jeu, complet, composé de:
Serie completa, consistente in:

39-581-01-07

39-584-20-07

32-865-01-07

Verlängerungsrohr
Interchangeable tube
Tubo de extension
Tube rallonge
Tubo allunghi

39-584-20-07 **22 cm**

39-584-30-07 **32 cm**

39-584-40-07 **41 cm**

Handgriff
Handle
Mango
Manche
Manico

39-581-01-07

Aufsatz
Tip
Punta
Embout
Punta

32-865-01-07

Weitere Aufsätze siehe Seite 732 ff
Further tips see page 732 ff
Más pinzas miren página 732 ff
Autres embouts voir page 732 ff
Altri pinzi vedi pagina 732 ff

➔ 39-600-01-07 -
39-647-01-07

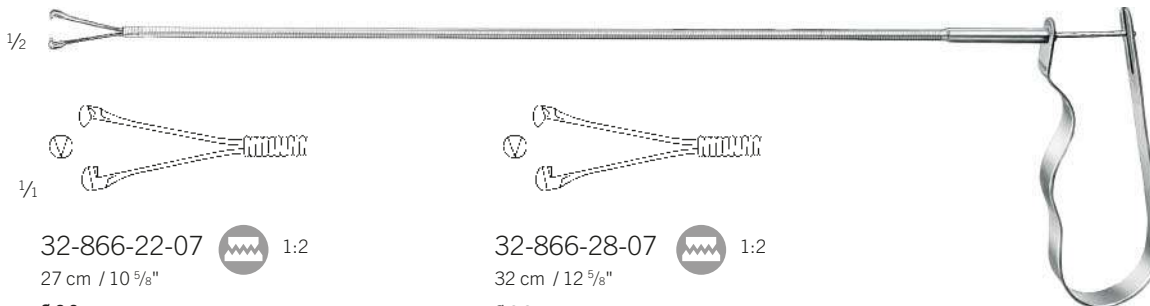

32-866-22-07  1:2
27 cm / 10 5/8"

Ø 3,0 mm
Schaftlänge
shaft length
longitud del vástago
longueur de la tige
lunghezza dell'asta

225 mm

flexibler Schaft
flexible shaft
vástago flexible
tige flexible
asta flessibile

32-866-28-07  1:2
32 cm / 12 5/8"

Ø 3,0 mm
Schaftlänge
shaft length
longitud del vástago
longueur de la tige
lunghezza dell'asta

270 mm

flexibler Schaft
flexible shaft
vástago flexible
tige flexible
asta flessibile

Uteruslöffel, Uterusküretten

Uterine Scoops, Uterine Curettes
 Cucharillas uterinas, Curetas uterinas
 Curettes utérines, Curettes utérines
 Curette uterine, Curette uterine

Gynäkologie

Gynecology
 Ginecología
 Gynécologie
 Ginecologia

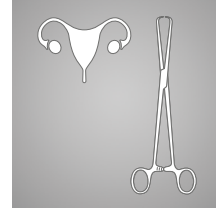

Fig. 1
 32-900-01-07
 23 cm / 9"
 10 x 7 mm



Fig. 2
 32-900-02-07
 23,5 cm / 9 3/8"
 12 x 8 mm

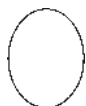

Fig. 3
 32-900-03-07
 24 cm / 9 1/2"
 13 x 10 mm



Fig. 4
 32-900-04-07
 24 cm / 9 1/2"
 16 x 12 mm

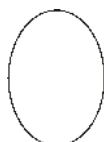

Fig. 5
 32-900-05-07
 24 cm / 9 1/2"
 18 x 13 mm

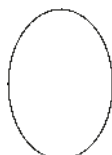

Fig. 6
 32-900-06-07
 24 cm / 9 1/2"
 20 x 15 mm



Fig. 1
 32-906-01-07
 10 x 7 mm



Fig. 2
 32-906-02-07
 12 x 8 mm



Fig. 3
 32-906-03-07
 13 x 10 mm



Fig. 4
 32-906-04-07
 16 x 12 mm



Fig. 5
 32-906-05-07
 18 x 13 mm

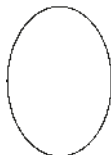

Fig. 6
 32-906-06-07
 20 x 15 mm



13 mm
 stumpf
 blunt
 romo
 mousse
 smusso



Simon
 32-900-01-07 -
 32-900-06-07
 scharf, fest
 sharp, rigid
 cortante, rígido
 tranchante, rigide
 tagliente, rigido



Schröder
 32-906-01-07 -
 32-906-06-07
 30 cm / 11 5/8"
 scharf, fest
 sharp, rigid
 cortante, rígido
 tranchante, rigide
 tagliente, rigido



Blake
 32-919-00-07
 27,5 cm / 10 7/8"

8 mm
 scharf
 sharp
 cortante
 tranchante
 taglient

Uterusküretten

Uterine Curettes
Curetas uterinas
Curettes utérines
Curette uterine



Recamier

32-920-05-07 -
32-920-40-07

Recamier

32-921-05-07 -
32-921-40-07

Sims

32-926-05-07 -
32-926-40-07

Sims

32-927-05-07 -
32-927-40-07

Fig.	Breite width anchura largeur larghezza	scharf, fest sharp, rigid cortante, rígido tranchante, rigide tagliente, rigido	scharf, biegsam sharp, malleable cortante, maleable tranchante, malléable tagliente, malleabile
00	5 mm	32-920-05-07	32-921-05-07
0	6 mm	32-920-06-07	32-921-06-07
1	7 mm	32-920-07-07	32-921-07-07
2	8 mm	32-920-08-07	32-921-08-07
3	9 mm	32-920-09-07	32-921-09-07
4	11 mm	32-920-11-07	32-921-11-07
5	12 mm	32-920-12-07	32-921-12-07
6	14 mm	32-920-14-07	32-921-14-07
7	15 mm	32-920-15-07	32-921-15-07
8	16 mm	32-920-16-07	32-921-16-07
9	19 mm	32-920-19-07	32-921-19-07
10	20 mm	32-920-20-07	32-921-20-07
11	21 mm	32-920-21-07	32-921-21-07
12	23 mm	32-920-23-07	32-921-23-07
13	25 mm	32-920-25-07	32-921-25-07
14	30 mm	32-920-30-07	32-921-30-07
15	35 mm	32-920-35-07	32-921-35-07
16	40 mm	32-920-40-07	32-921-40-07

Fig.	Breite width anchura largeur larghezza	stumpf, fest blunt, rigid romo, rígido mousse, rigide smusso, rigido	stumpf, biegsam blunt, malleable romo, maleable mousse, malléable smusso, malleabile
00	5 mm	32-926-05-07	32-927-05-07
0	6 mm	32-926-06-07	32-927-06-07
1	7 mm	32-926-07-07	32-927-07-07
2	8 mm	32-926-08-07	32-927-08-07
3	9 mm	32-926-09-07	32-927-09-07
4	11 mm	32-926-11-07	32-927-11-07
5	12 mm	32-926-12-07	32-927-12-07
6	14 mm	32-926-14-07	32-927-14-07
7	15 mm	32-926-15-07	32-927-15-07
8	16 mm	32-926-16-07	32-927-16-07
9	19 mm	32-926-19-07	32-927-19-07
10	20 mm	32-926-20-07	32-927-20-07
11	21 mm	32-926-21-07	32-927-21-07
12	23 mm	32-926-23-07	32-927-23-07
13	25 mm	32-926-25-07	32-927-25-07
14	30 mm	32-926-30-07	32-927-30-07
15	35 mm	32-926-35-07	32-927-35-07
16	40 mm	32-926-40-07	32-927-40-07

Uterusküretten

Uterine Curettes
Curetas uterinas
Curettes utérines
Curette uterine

Gynäkologie

Gynecology
Ginecología
Gynécologie
Ginecologia

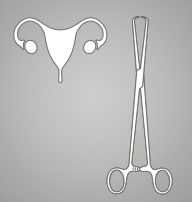

Uterusküretten, Absaugküretten

Uterine Curettes, Suction Curettes

Curetas uterinas, Curetas aspiradoras

Curettes utérines, Curettes d'aspiration

Curette uterine, Curette per aspirazione

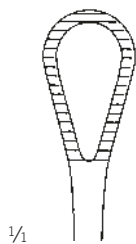

1/1

10 mm
32-924-10-07

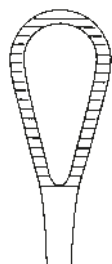

12 mm
32-924-12-07

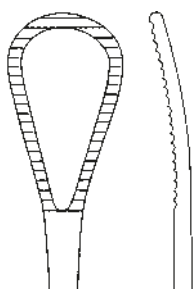

14 mm
32-924-14-07



1/2

Greene
32-924-10-07 -
32-924-14-07
28 cm / 11 "



1/1

Ø 3,0 mm
32-989-03-01



Ø 4,5 mm
32-989-04-01



Ø 6,0 mm
32-989-06-01



Ø 8,0 mm
32-989-08-01



Ø 10 mm
32-989-10-01



Ø 12 mm
32-989-12-01



1/2

32-989-03-01 -
32-989-14-01
29 cm / 11 3/8"

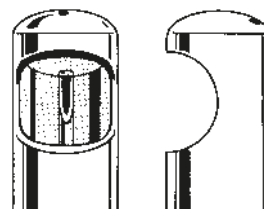

Ø 14 mm
32-989-14-01



1/2

32-989-50-01
11 cm / 4 3/8"
Kupplungsstück
Coupling Piece
Pieza de acoplamiento
Pièce de raccordement
Pezzo di collegamento