

Naht
Suture
Sutura
Suture
Sutura

20

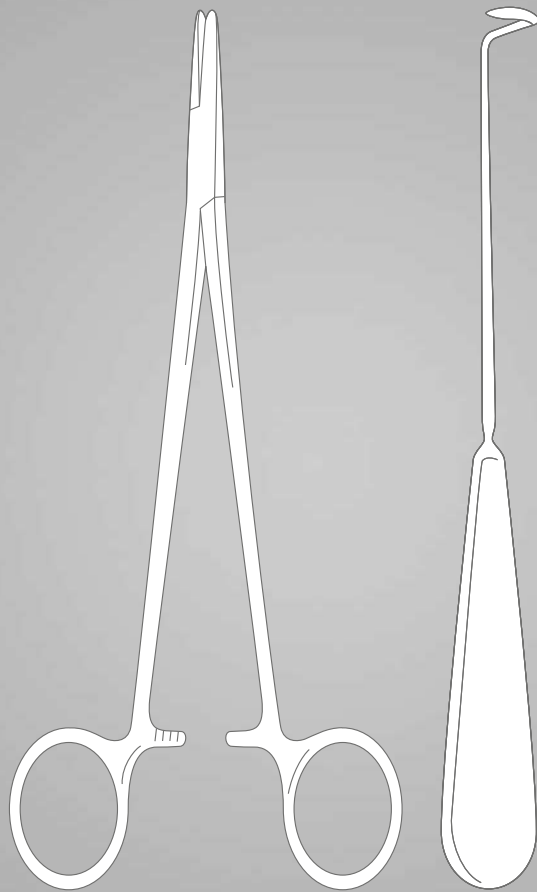

Chirurgische Nadeln

Surgical Needles

Agujas quirúrgicas

Aiguilles chirurgicales

Aghi chirurgici

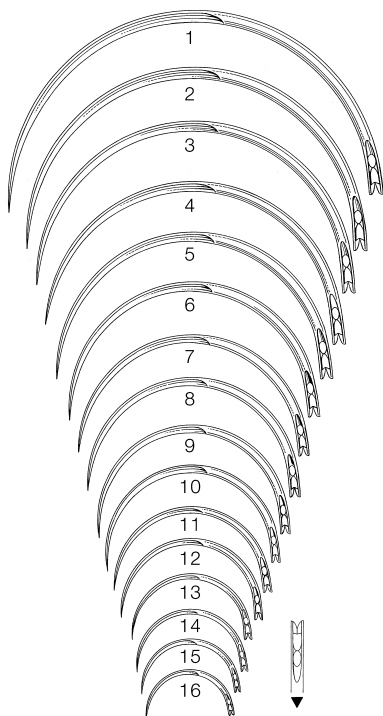

| | Fig. |
|--------------|------|
| 20-123-01-04 | 1 |
| 20-123-02-04 | 2 |
| 20-123-03-04 | 3 |
| 20-123-04-04 | 4 |
| 20-123-05-04 | 5 |
| 20-123-06-04 | 6 |
| 20-123-07-04 | 7 |
| 20-123-08-04 | 8 |
| 20-123-09-04 | 9 |
| 20-123-10-04 | 10 |
| 20-123-11-04 | 11 |
| 20-123-12-04 | 12 |
| 20-123-13-04 | 13 |
| 20-123-14-04 | 14 |
| 20-123-15-04 | 15 |
| 20-123-16-04 | 16 |

gebogen 1/2 Kreis, VE = 12 Stück
curved, 1/2 circle, SU = 12/pack
curvas 1/2 círculo, UV = 12 piezas
courbes 1/2 cercle, UC = 12 untiés
curvi 1/2 circolo, UV = 12 pezzi

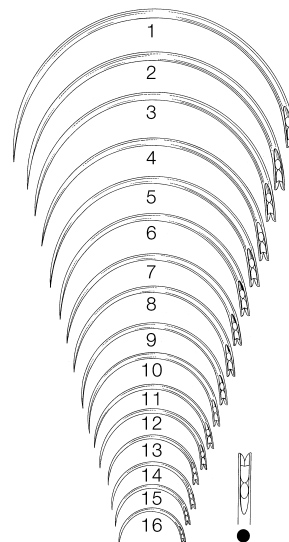

| | Fig. |
|--------------|------|
| 20-127-01-04 | 1 |
| 20-127-02-04 | 2 |
| 20-127-03-04 | 3 |
| 20-127-04-04 | 4 |
| 20-127-05-04 | 5 |
| 20-127-06-04 | 6 |
| 20-127-07-04 | 7 |
| 20-127-08-04 | 8 |
| 20-127-09-04 | 9 |
| 20-127-10-04 | 10 |
| 20-127-11-04 | 11 |
| 20-127-12-04 | 12 |
| 20-127-13-04 | 13 |
| 20-127-14-04 | 14 |
| 20-127-15-04 | 15 |
| 20-127-16-04 | 16 |

gebogen 1/2 Kreis, VE = 12 Stück
curved, 1/2 circle, SU = 12/pack
curvas 1/2 círculo, UV = 12 piezas
courbes 1/2 cercle, UC = 12 untiés
curvi 1/2 circolo, UV = 12 pezzi

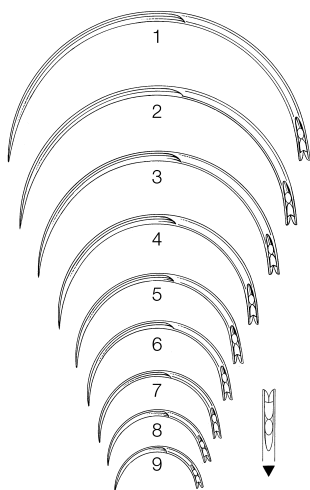

| | Fig. |
|--------------|------|
| 20-133-01-04 | 1 |
| 20-133-02-04 | 2 |
| 20-133-03-04 | 3 |
| 20-133-04-04 | 4 |
| 20-133-05-04 | 5 |
| 20-133-06-04 | 6 |
| 20-133-07-04 | 7 |
| 20-133-08-04 | 8 |
| 20-133-09-04 | 9 |

gebogen 1/2 Kreis, VE = 12 Stück
curved, 1/2 circle, SU = 12/pack
curvas 1/2 círculo, UV = 12 piezas
courbes 1/2 cercle, UC = 12 untiés
curvi 1/2 circolo, UV = 12 pezzi

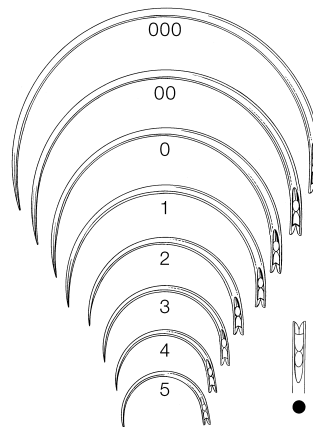

| | Fig. |
|--------------|------|
| 20-154-10-04 | 0 |
| 20-154-20-04 | 00 |
| 20-154-30-04 | 000 |
| 20-155-01-04 | 1 |
| 20-155-02-04 | 2 |
| 20-155-03-04 | 3 |
| 20-155-04-04 | 4 |
| 20-155-05-04 | 5 |

gebogen 1/2 Kreis, VE = 12 Stück
curved, 1/2 circle, SU = 12/pack
curvas 1/2 círculo, UV = 12 piezas
courbes 1/2 cercle, UC = 12 untiés
curvi 1/2 circolo, UV = 12 pezzi

Chirurgische Nadeln

Surgical Needles

Agujas quirúrgicas

Aiguilles chirurgicales

Aghi chirurgici

Naht

Suture

Sutura

Suture

Sutura

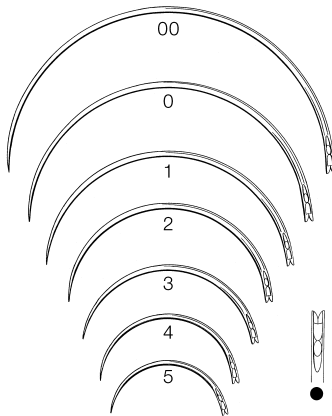
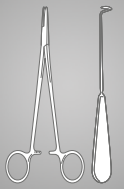

| | Fig. |
|--------------|------|
| 20-175-10-04 | 0 |
| 20-175-20-04 | 00 |
| 20-176-01-04 | 1 |
| 20-176-02-04 | 2 |
| 20-176-03-04 | 3 |
| 20-176-04-04 | 4 |
| 20-176-05-04 | 5 |

gebogen 1/2 Kreis, VE = 12 Stück
curved, 1/2 circle, SU = 12/pack
curvas 1/2 círculo, UV = 12 piezas
courbes 1/2 cercle, UC = 12 untiés
curvi 1/2 circolo, UV = 12 pezzi

Mikro-Nadelhalter

Micro Needle Holders

Micro Porta-agujas

Micro porte-aiguilles

Micro Portaghi



1/1



1/2

20-002-15-07 -
20-019-18-09

| | | mit Sperre with lock con trinquete avec cran d'arrêt con arresto | mit Sperre with lock con trinquete avec cran d'arrêt con arresto | ohne Sperre w/o lock sin trinquete sans cran d'arrêt senza arresto | ohne Sperre w/o lock sin trinquete sans cran d'arrêt senza arresto |
|----------------|----|--|--|--|--|
| | Ø | 0.40 mm | 0.40 mm | 0.40 mm | 0.40 mm |
| 15 cm / 5 7/8" | St | 20-002-15-07 | 20-003-15-07 | 20-004-15-07 | 20-005-15-07 |
| | Ti | 20-016-15-09 | 20-017-15-09 | 20-018-15-09 | 20-019-15-09 |
| 18 cm / 7 1/8" | St | 20-002-18-07 | 20-003-18-07 | 20-004-18-07 | 20-005-18-07 |
| | Ti | 20-016-18-09 | 20-017-18-09 | 20-018-18-09 | 20-019-18-09 |



1/1



1/2

20-010-15-07 -
20-023-23-09

| | | mit Sperre with lock con trinquete avec cran d'arrêt con arresto | mit Sperre with lock con trinquete avec cran d'arrêt con arresto | ohne Sperre w/o lock sin trinquete sans cran d'arrêt senza arresto | ohne Sperre w/o lock sin trinquete sans cran d'arrêt senza arresto |
|----------------|----|--|--|--|--|
| | Ø | 0.80 mm | 0.80 mm | 0.80 mm | 0.80 mm |
| 15 cm / 5 7/8" | St | 20-010-15-07 | 20-011-15-07 | 20-012-15-07 | 20-013-15-07 |
| | Ti | 20-020-15-09 | 20-021-15-09 | 20-022-15-09 | 20-023-15-09 |
| 18 cm / 7 1/8" | St | 20-010-18-07 | 20-011-18-07 | 20-012-18-07 | 20-013-18-07 |
| | Ti | 20-020-18-09 | 20-021-18-09 | 20-022-18-09 | 20-023-18-09 |
| 21 cm / 8 2/8" | St | 20-010-21-07 | 20-011-21-07 | 20-012-21-07 | 20-013-21-07 |
| | Ti | 20-020-21-09 | 20-021-21-09 | 20-022-21-09 | 20-023-21-09 |
| 23 cm / 9" | St | 20-010-23-07 | 20-011-23-07 | 20-012-23-07 | 20-013-23-07 |
| | Ti | 20-020-23-09 | 20-021-23-09 | 20-022-23-09 | 20-023-23-09 |

Mikro-Nadelhalter

Micro Needle Holders
 Micro Porta-agujas
 Micro porte-aiguilles
 Micro Portaghi

Naht

Suture
 Sutura
 Sutura
 Sutura

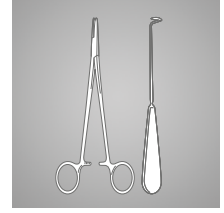

1/1



1/2

20-030-15-07 -
 20-033-23-09

| | | mit Sperre with lock con trinquete avec cran d'arrêt con arresto | mit Sperre with lock con trinquete avec cran d'arrêt con arresto | ohne Sperre w/o lock sin trinquete sans cran d'arrêt senza arresto | ohne Sperre w/o lock sin trinquete sans cran d'arrêt senza arresto |
|----------------|----|--|--|--|--|
| | Ø | 1.2 mm | 1.2 mm | 1.2 mm | 1.2 mm |
| 15 cm / 5 7/8" | St | 20-030-15-07 | 20-031-15-07 | 20-032-15-07 | 20-033-15-07 |
| | Ti | 20-030-15-09 | 20-031-15-09 | 20-032-15-09 | 20-033-15-09 |
| 18 cm / 7 1/8" | St | 20-030-18-07 | 20-031-18-07 | 20-032-18-07 | 20-033-18-07 |
| | Ti | 20-030-18-09 | 20-031-18-09 | 20-032-18-09 | 20-033-18-09 |
| 21 cm / 8 2/8" | St | 20-030-21-07 | 20-031-21-07 | 20-032-21-07 | 20-033-21-07 |
| | Ti | 20-030-21-09 | 20-031-21-09 | 20-032-21-09 | 20-033-21-09 |
| 23 cm / 9" | St | 20-030-23-07 | 20-031-23-07 | 20-032-23-07 | 20-033-23-07 |
| | Ti | 20-030-23-09 | 20-031-23-09 | 20-032-23-09 | 20-033-23-09 |



1/1



1/2

20-048-18-07 -
 20-051-18-07

18 cm / 7 1/8"

| | | mit Sperre with lock con trinquete avec cran d'arrêt con arresto | mit Sperre with lock con trinquete avec cran d'arrêt con arresto | ohne Sperre without lock sin trinquete sans cran d'arrêt senza arresto | ohne Sperre without lock sin trinquete sans cran d'arrêt senza arresto |
|----------------|----|--|--|--|--|
| 18 cm / 7 1/8" | St | 20-048-18-07 | 20-049-18-07 | 20-050-18-07 | 20-051-18-07 |

Mikro-Nadelhalter

Micro Needle Holders

Micro Porta-agujas

Micro porte-aiguilles

Micro Portaghi



1/2



20-298-10-07
10,5 cm / 4 1/8"

20-298-11-07
11,5 cm / 4 5/8"



20-299-10-07
10,5 cm / 4 1/8"

20-299-11-07
11,5 cm / 4 5/8"

Barraquer-Troutman
20-298-10-07 -
20-299-11-07



1/2

1/1



| | | ohne Sperre w/o ratchet sin trinquete sans cran d'arrêt senza arresto | mit Sperre with ratchet con trinquete avec cran d'arrêt con arresto |
|-------------------------|----|---|---|
| 11,5 cm / 4 5/8" | St | 20-300-11-07 | — |
| 13,5 cm / 5 3/8" | St | 20-300-13-07 | 20-300-14-07 |

Barraquer
20-300-11-07 -
20-300-14-07

Mikro-Nadelhalter

Micro Needle Holders
Micro Porta-agujas
Micro porte-aiguilles
Micro Portaghi

Naht

Sutura
Sutura
Sutura
Sutura

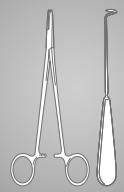

Barraquer
20-301-13-07

13,5 cm / 5 3/8"

sehr feines Maul
very delicate jaw
boca muy delicada
mors très fin
morso strafino



Castroviejo-Fino
20-302-01-07

13 cm / 5 1/8"

sehr feines Maul
very delicate jaw
boca muy delicada
mors très fin
morso strafino



Castroviejo-Fino
20-303-01-07

13 cm / 5 1/8"

sehr feines Maul
very delicate jaw
boca muy delicada
mors très fin
morso strafino



Castroviejo-Fino
20-304-01-07

13 cm / 5 1/8"

sehr feines Maul, mit Sperre
very delicate jaw, with lock
boca muy delicada, con cierre
mors très fin, avec serrure
morso strafino, con fermo



Castroviejo-Fino
20-305-01-07

13 cm / 5 1/8"

sehr feines Maul, mit Sperre
very delicate jaw, with lock
boca muy delicada, con cierre
mors très fin, avec serrure
morso strafino, con fermo



Castroviejo-Fino
20-303-09-07

9 cm / 3 4/8"



Castroviejo-Fino
20-304-09-07

9 cm / 3 4/8"

Mikro-Nadelhalter

Micro Needle Holders

Micro Porta-agujas

Micro porte-aiguilles

Micro Portaghi

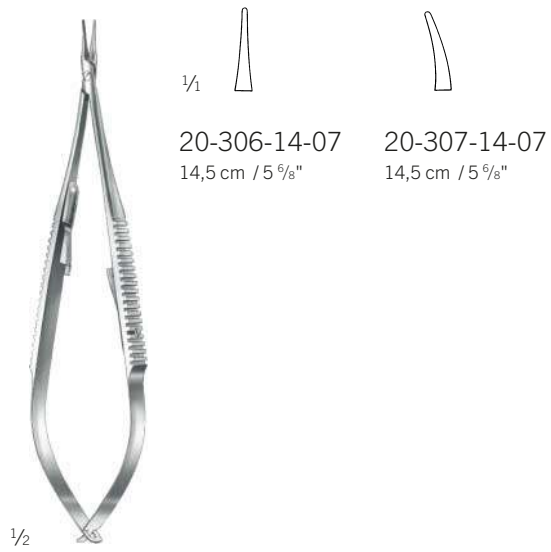

Castroviejo
20-306-14-07 -
20-307-14-07

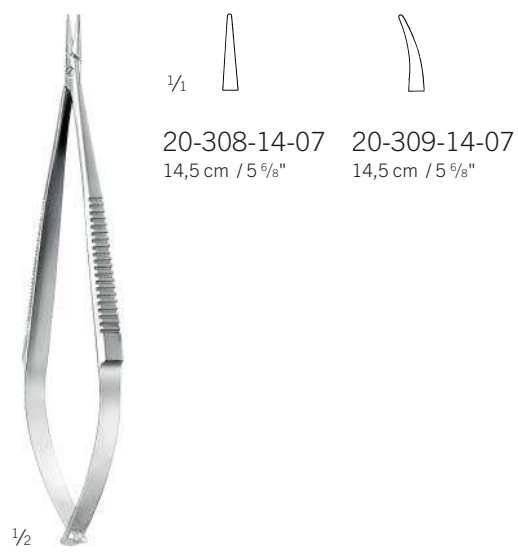

Castroviejo
20-308-14-07 -
20-309-14-07

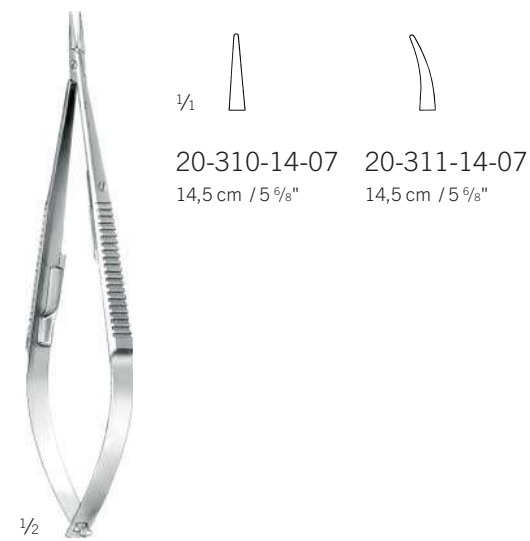

Castroviejo
20-310-14-07 -
20-311-14-07



Castroviejo
20-313-14-07
14,5 cm / 5 6/8"

Nadelhalter

Needle Holders

Porta-agujas

Porte-aiguilles

Portaghi

Naht

Suture

Sutura

Suture

Sutura

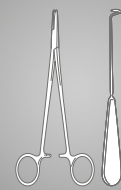

1/1



20-326-12-07

12 cm / 4 7/8"

beide Maulteile gefenstert
both jaws fenestrated
ambas mordazas fenestradas
les deux mors fenêtrés
entrambe le gole a finestra



20-328-12-07

13 cm / 5 1/8"

längsgerieftes Maul
jaw with longitudinal serration
boca con estrías longitudi-
mors avec rainures longitudinales
morso con strie longitudinali



1/1



Collier

20-332-12-07

12,5 cm / 4 7/8"

beide Maulteile durchgehend gefenstert
both jaws totally fenestrated
ambas mordazas completamente fenestradas
les deux mors fenêtrés sur toute leur longueur
entrambe le gole completamente a finestra

Derf

20-326-12-07 -

20-328-12-07

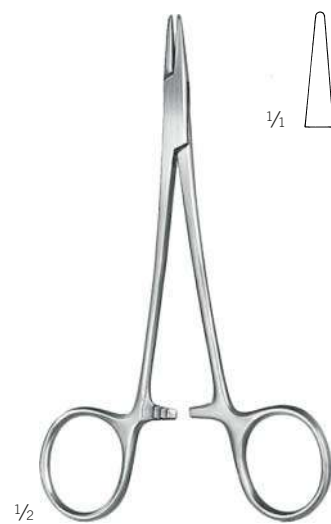

1/1



Webster

20-334-13-07

13 cm / 5 1/8"

glattes Maul
smooth jaw
boca lisa
mors lisse
morso liscio



1/1



Halsey

20-336-13-07

13,5 cm / 5 3/8"

glattes Maul
smooth jaw
boca lisa
mors lisse
morso liscio

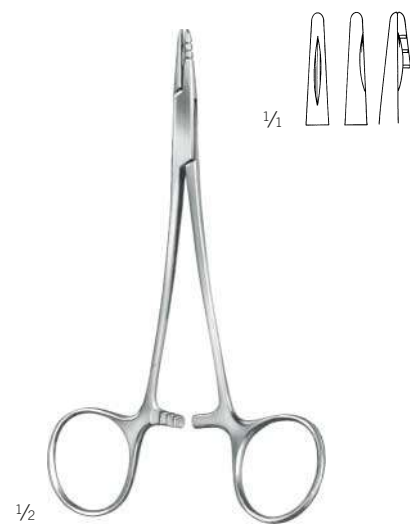

1/1

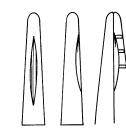

Neivert

20-338-13-07

12,5 cm / 4 7/8"

glattes Maul mit Spezialkehlung
smooth jaw, special groove
boca lisa, especialmente acanalada
mors lisse, avec stries spéciales
morso liscio con scannellatura speciale

Nadelhalter

Needle Holders

Porta-agujas

Porte-aiguilles

Portaghi

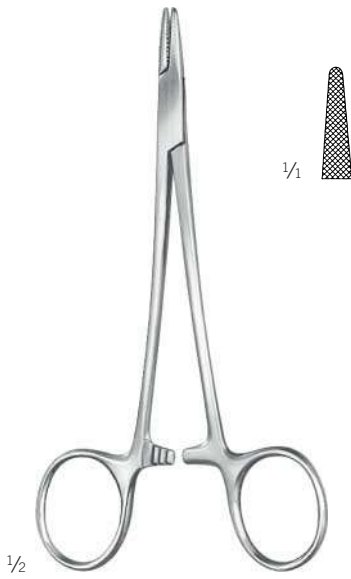

Hegar-Baumgartner
20-340-14-07
14,5 cm / 5 7/8"



Brown
20-344-13-07 -
20-344-18-07
kräftiges Modell
heavy pattern
modelo fuerte
modèle fort
modello forte

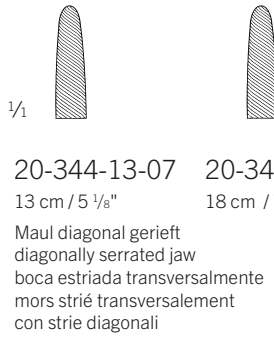

Crile-Murray
20-348-15-07
15 cm / 5 7/8"
schlankes Modell
slender pattern
modelo delgado
modèle gracile
modello delicato



Crile-Wood
20-350-15-07
15 cm / 5 7/8"



Adson
20-360-18-07
18,5 cm / 7 3/8"
beide Maulteile durchgehend gefenestert
both jaws fenestrated throughout
ambas mordazas completamente fenestradas
les deux mors fenêtrés sur toute leur longueur
entrambe le gole completamente a finestra



Metzenbaum
20-364-18-07
18,5 cm / 7 3/8"
ein Maulteil gekehlt und gefenestert
one grooved and fenestrated jaw
un lado de la boca acanalado y fenestrado
un côté de mors strié et fenêtré
una parte del morso scannellata e fenestrata

Nadelhalter

Needle Holders
Porta-agujas
Porte-aiguilles
Portaghi

Naht

Suture
Sutura
Suture
Sutura

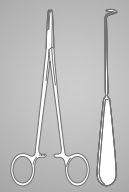

M. G. Hospital
20-384-17-07
18 cm / 7 1/8"
kräftiges Modell
heavy pattern
modelo fuerte
modèle fort
modello forte



Mayo-Hegar
20-390-14-07 -
20-390-30-07

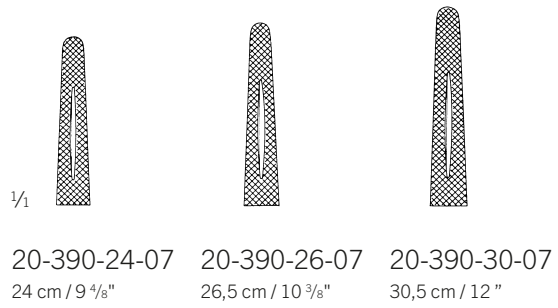
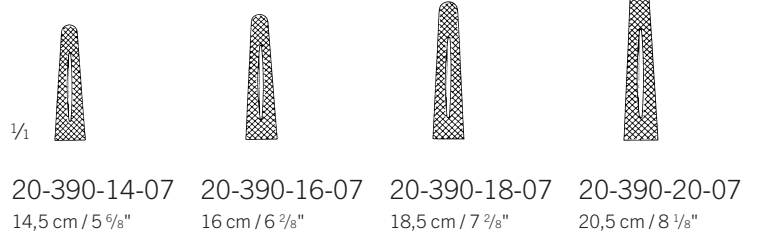

Mayo-Hegar
20-396-16-07 -
20-396-20-07
schlankes Modell
slender pattern
modelo delgado
modèle gracile
modello delicato

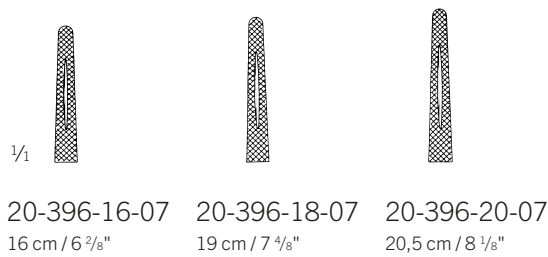

Heaney
20-403-21-07
20,5 cm / 8 1/8"

20

Nadelhalter

Needle Holders

Porta-agujas

Porte-aiguilles

Portaghi



$\frac{1}{2}$

Jameson
20-404-23-07
23 cm / 9"



$\frac{1}{2}$

$\frac{1}{2}$

Masson
20-408-27-07
26,5 cm / 10 $\frac{3}{8}$ "
kräftiges Modell
heavy pattern
modelo fuerte
modèle fort
modello forte



$\frac{1}{2}$

$\frac{1}{2}$

Finochietto
20-415-27-07
26,5 cm / 10 $\frac{3}{8}$ "



Wangenstein
 20-420-27-07
 26,5 cm / 10 3/8"



Johnson
 20-437-27-07
 27 cm / 10 5/8"

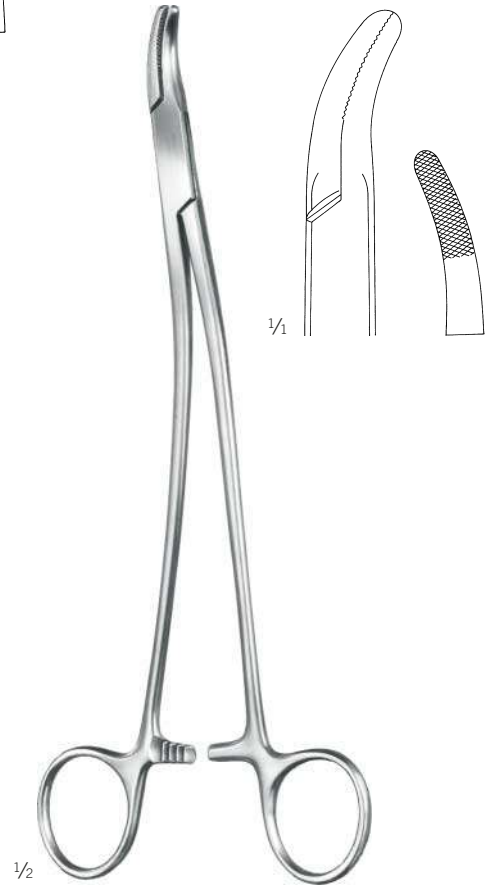

Stratte
 20-451-23-07
 23 cm / 9"

Nadelhalter

Needle Holders

Porta-agujas

Porte-aiguilles

Portaghi

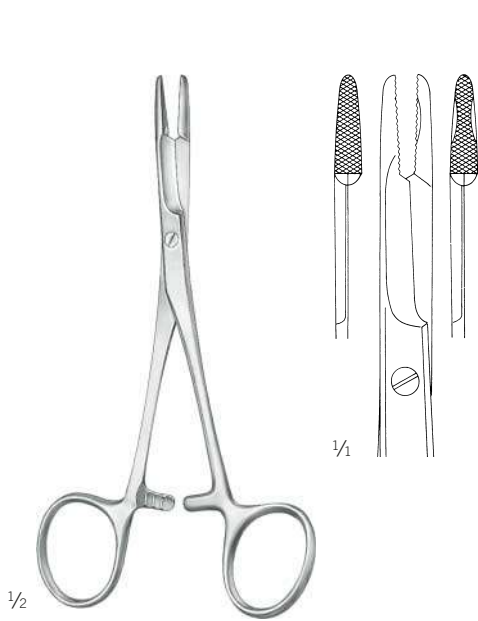

Olsen-Hegar
20-466-14-07
14 cm / 5 1/8"

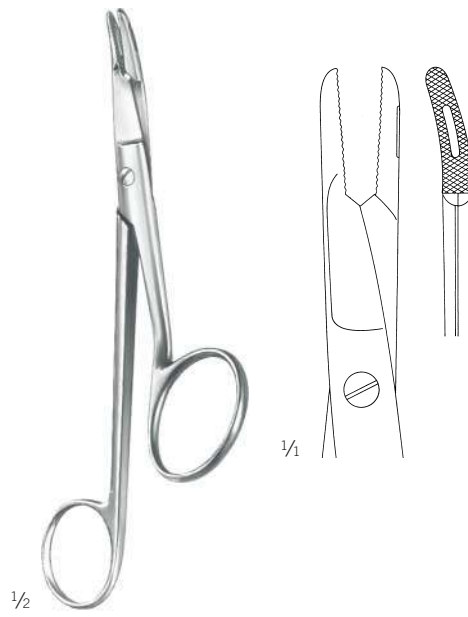

Gillies
20-469-16-07
16 cm / 6 2/8"



Crile
20-500-15-07
15 cm / 5 7/8"

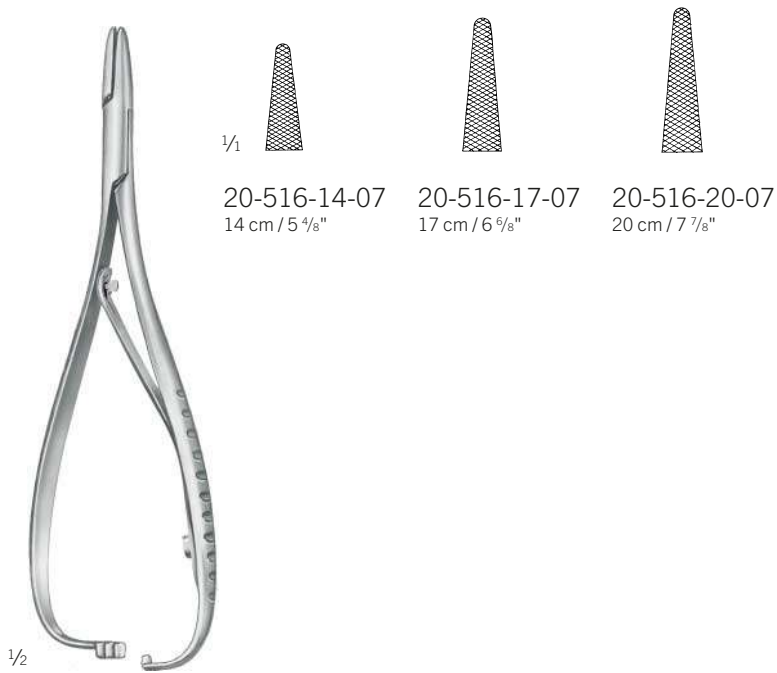

Mathieu
20-516-14-07 -
20-516-20-07

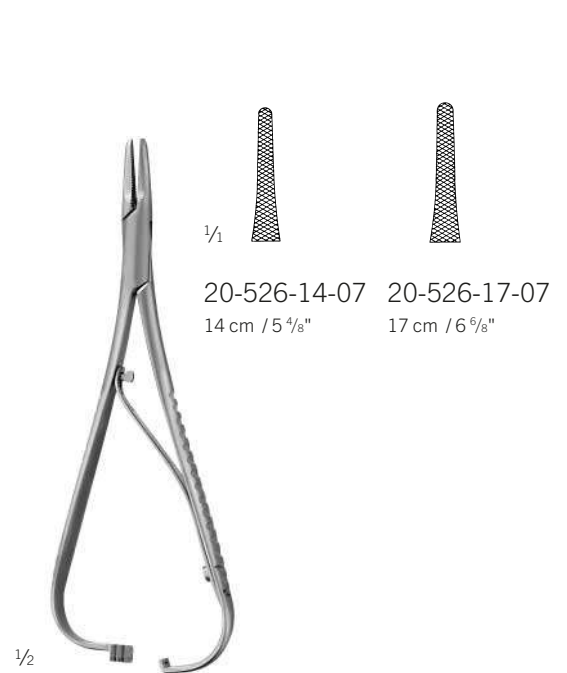

Mathieu
20-526-14-07 -
20-526-17-07
schlankes Modell
slender pattern
modelo delgado
modèle gracile
modello delicato

Mikro-Nadelhalter, Nadelhalter

Micro Needle Holders, Needle Holders

Micro Porta-agujas, Porta-agujas

Micro porte-aiguilles, Porte-aiguilles

Micro Portaghi, Portaghi

Naht

Sutura

Sutura

Sutura

Sutura

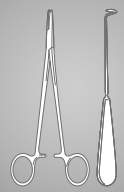

TC GOLD

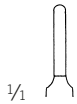

- 6-0 - 12-0
- Smooth

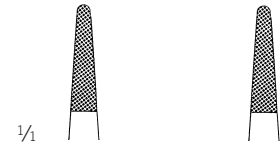

Webster
20-604-13-07
13 cm / 5 1/8"

Crile-Wood
20-604-15-07
15 cm / 5 7/8"

- 4-0 - 6-0
- Mini



mit Durchdrücksperrung auch für Linkshänder geeignet
with automatic release ratchet also for lefthanders
con cremallera automática también para zurdos
avec crémaillère automatique aussi pour gauchers
con cremagliera automatica anche per mancini

Hepp-Scheidel
20-602-18-07
18,5 cm / 7 3/8"

20-604-13-07 -
20-604-15-07



safety-wave

diamond-coated

- 2-0 - 4-0



| | | mit Sperre with ratchet con trinquete avec cran d'arrêt con arresto | mit Sperre with ratchet con trinquete avec cran d'arrêt con arresto | ohne Sperre w/o ratchet sin trinquete sans cran d'arrêt senza arresto | ohne Sperre w/o ratchet sin trinquete sans cran d'arrêt senza arresto |
|----------------|----|---|---|---|---|
| | Ø | 2.0 mm | 2.0 mm | 2.0 mm | 2.0 mm |
| 15 cm / 5 7/8" | St | 20-606-15-07 | 20-605-15-07 | 20-608-15-07 | 20-607-15-07 |
| 18 cm / 7 1/8" | St | 20-606-18-07 | 20-605-18-07 | 20-608-18-07 | 20-607-18-07 |
| 21 cm / 8 2/8" | St | 20-606-21-07 | 20-605-21-07 | 20-608-21-07 | 20-607-21-07 |
| 23 cm / 9" | St | 20-606-23-07 | 20-605-23-07 | 20-608-23-07 | 20-607-23-07 |

TC GOLD

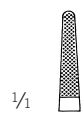

- 5-0 - 8-0
- Micro



Jaboma
20-610-18-07
18 cm / 7 1/8"

20

20-605-15-07 -
20-608-23-07

Mikro-Nadelhalter, Nadelhalter

Micro Needle Holders, Needle Holders

Micro Porta-agujas, Porta-agujas

Micro porte-aiguilles, Porte-aiguilles

Micro Portaghi, Portaghi



2-0 - 5-0



1/1



4-0 - 6-0



Mini

1/2

Par-Style
20-600-11-07
11,5 cm / 4 1/2"



1/2

Heavy Duty
20-613-19-07 -
20-613-23-07

1/1



20-613-19-07
19 cm / 7 4/8"



20-613-23-07
23 cm / 9"

Mikro-Nadelhalter

Micro Needle Holders
Micro Porta-agujas
Micro porte-aiguilles
Micro Portaghi

Naht

Sutura
Sutura
Sutura
Sutura

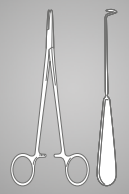

1/2



8-0 - 9-0

1/4



| | | | | | |
|----|---|---|---|---|---|
| | ● | mit Sperre with ratchet con trinquete avec cran d'arrêt con arresto | mit Sperre with ratchet con trinquete avec cran d'arrêt con arresto | ohne Sperre w/o ratchet sin trinquete sans cran d'arrêt senza arresto | ohne Sperre w/o ratchet sin trinquete sans cran d'arrêt senza arresto |
| ∅ | | 0.40 mm | 0.40 mm | 0.40 mm | 0.40 mm |
| St | | 20-614-02-07 | 20-615-01-07 | 20-614-01-07 | 20-615-02-07 |

20-614-01-07 -
20-615-02-07
14,5 cm / 5 7/8"

20



1/2



8-0 - 9-0

1/4



| | | | | | |
|----|---|---|---|---|---|
| | ● | mit Sperre with ratchet con trinquete avec cran d'arrêt con arresto | ohne Sperre w/o ratchet sin trinquete sans cran d'arrêt senza arresto | ohne Sperre w/o ratchet sin trinquete sans cran d'arrêt senza arresto | mit Sperre with ratchet con trinquete avec cran d'arrêt con arresto |
| ∅ | | 0.40 mm | 0.40 mm | 0.40 mm | 0.40 mm |
| St | | 20-614-04-07 | 20-615-04-07 | 20-614-03-07 | 20-615-03-07 |

20-614-03-07 -
20-615-04-07
14,5 cm / 5 7/8"

Mikro-Nadelhalter

Micro Needle Holders

Micro Porta-agujas

Micro porte-aiguilles

Micro Portaghi

TC GOLD



1/2

Castroviejo
20-620-00-07 -
20-621-21-07

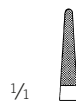

1/4

20-620-00-07

14,5 cm / 5 6/8"



20-620-01-07

14,5 cm / 5 6/8"



20-620-14-07

14,5 cm / 5 6/8"



20-620-18-07

18 cm / 7 1/8"



1/4

20-620-21-07

22 cm / 8 5/8"



20-621-14-07

14,5 cm / 5 6/8"



20-621-18-07

18 cm / 7 1/8"



20-621-21-07

22 cm / 8 5/8"



Mikro-Nadelhalter

Micro Needle Holders
Micro Porta-agujas
Micro porte-aiguilles
Micro Portaghi

Naht

Sutura
Sutura
Sutura
Sutura

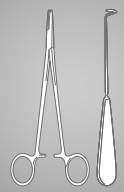

TC GOLD



Castroviejo
20-624-13-07
12,5 cm / 4 7/8"
mit Sperre
with lock
con cierre
avec serrure
con fermo



Barraquer
20-626-13-07
13 cm / 5 1/8"
mit Sperre
with lock
con cierre
avec serrure
con fermo



Barraquer
20-628-13-07
13 cm / 5 1/8"
ohne Sperre
w/o ratchet
sin trinquete
sans cran d'arrêt
senza arresto



Webster
20-630-13-07
13 cm / 5 1/8"



Kilner
20-631-13-07
14,5 cm / 5 6/8"

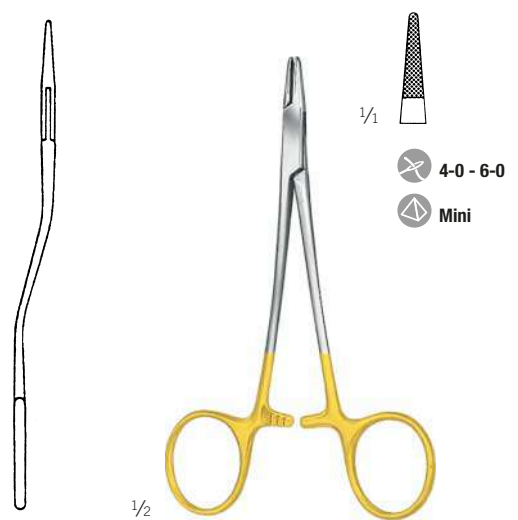

Derf
20-632-12-07
12 cm / 4 6/8"

Nadelhalter

Needle Holders

Porta-agujas

Porte-aiguilles

Portaghi

TC GOLD

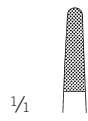

20-634-13-07
13 cm / 5 1/8"



Hegar-Baumgartner
20-634-13-07 -
20-634-14-07

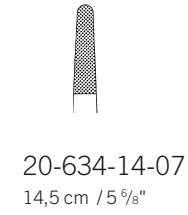

20-634-14-07
14,5 cm / 5 6/8"

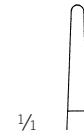

20-636-13-07
13 cm / 5 1/8"



Halsey
20-636-13-07 -
20-637-13-07



20-637-13-07
13 cm / 5 1/8"



Webster
20-637-12-07
12 cm / 4 6/8"

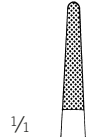

Crile-Wood
20-638-15-07
15 cm / 5 7/8"



Crile-Wood
20-638-20-07
20,5 cm / 8 1/8"

Nadelhalter

Needle Holders

Porta-agujas

Porte-aiguilles

Portaghi

Naht

Sutura

Sutura

Sutura

Sutura

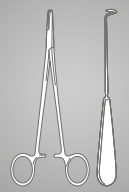

TC GOLD



1/2

Sarot
20-640-18-07 -
20-640-26-07

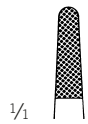

1/1

20-640-18-07
18 cm / 7 1/8"



0-6 - 4-0



Standard



20-640-20-07
20 cm / 7 7/8"



0-6 - 4-0



Standard



20-640-26-07
26 cm / 10 2/8"



0-6 - 4-0



Standard



1/2

Mayo-Hegar
20-642-16-07 -
20-642-30-07



1/1

20-642-16-07
16 cm / 6 2/8"



0-6 - 4-0



Standard



20-642-18-07
18,5 cm / 7 2/8"



0-6 - 4-0



Standard



20-642-20-07
20 cm / 7 7/8"



0-6 - 4-0



Standard

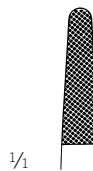

1/1

20-642-24-07
24 cm / 9 4/8"



0-6 - 4-0



Standard



20-642-26-07
26,5 cm / 10 3/8"



0-6 - 4-0



Standard



20-642-30-07
30 cm / 11 6/8"



0-6 - 4-0



Standard

20

Nadelhalter

Needle Holders

Porta-agujas

Porte-aiguilles

Portaghi

TC GOLD



1/2

Heaney
20-643-20-07 -
20-643-26-07



1/16

20-643-20-07
20,5 cm / 8 1/8"

0-6 - 4-0

Standard



20-643-24-07
24 cm / 9 4/8"

0-6 - 4-0

Standard



20-643-26-07
26,5 cm / 10 3/8"

0-6 - 4-0

Standard



1/2

DeBakey
20-646-18-07 -
20-646-31-07

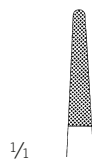

1/16

20-646-18-07
18 cm / 7 1/8"

4-0 - 6-0

Mini



20-646-20-07
20,5 cm / 8 1/8"

4-0 - 6-0

Mini



20-646-23-07
23 cm / 9"

4-0 - 6-0

Mini



1/16

20-646-26-07
26,5 cm / 10 3/8"

4-0 - 6-0

Mini



20-646-31-07
31 cm / 12 2/8"

4-0 - 6-0

Mini



1/2

Masson
20-648-27-07
26,5 cm / 10 3/8"

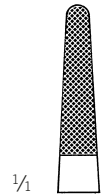

1/16

0-6 - 4-0

Standard

Nadelhalter

Needle Holders
Porta-agujas
Porte-aiguilles
Portaghi

Naht

Suture
Sutura
Suture
Sutura

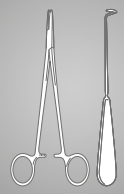

TC GOLD



1/2

Ryder (Martin)
20-650-13-07 -
20-650-26-07

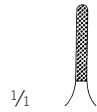

1/1

20-650-13-07
12,5 cm / 4 7/8"



20-650-15-07
15 cm / 5 7/8"



20-650-18-07
18 cm / 7 1/8"

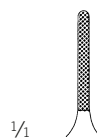

1/1

20-650-20-07
20 cm / 7 7/8"



20-650-23-07
23 cm / 9"



20-650-26-07
26 cm / 10 3/8"



1/1



1/2

Martin
20-652-15-07 -
20-652-20-07

elastisches Modell
elastic tip
modelo elástico
modèle souple
modello molle

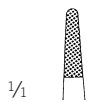

1/1

20-652-15-07
15 cm / 5 7/8"



20-652-17-07
17 cm / 6 5/8"



20-652-20-07
20,5 cm / 8 1/8"



1/2

Finochietto
20-653-27-07
26,5 cm / 10 3/8"
Normalprofil
standard profile
perfil estándar
profil normal
profilo normale

Nadelhalter

Needle Holders

Porta-agujas

Porte-aiguilles

Portaghi

TC GOLD

Ryder-Vascular
 20-654-13-07 -
 20-654-26-07
 schlankes Modell
 delicate pattern
 modelo delgado
 modèle gracile
 modelo gracile

Wangensteen
 20-656-27-07
 27 cm / 10 ⁵/₈"

| Model | Length (cm) | Length (in) | Size | Micro |
|--------------|-------------|----------------------------------|-----------|-------|
| 20-654-13-07 | 12 | 4 ⁶ / ₈ " | 5-0 - 8-0 | Micro |
| 20-654-15-07 | 15,5 | 6 ¹ / ₈ " | 5-0 - 8-0 | Micro |
| 20-654-18-07 | 17,5 | 6 ⁷ / ₈ " | 5-0 - 8-0 | Micro |
| 20-654-20-07 | 20 | 7 ⁷ / ₈ " | 5-0 - 8-0 | Micro |
| 20-654-23-07 | 22,5 | 8 ⁷ / ₈ " | 5-0 - 8-0 | Micro |
| 20-654-26-07 | 26 | 10 ² / ₈ " | 5-0 - 8-0 | Micro |

Legend:
 0-6 - 4-0
 Standard

Nadelhalter

Needle Holders
Porta-agujas
Porte-aiguilles
Portaghi

Naht

Suture
Sutura
Suture
Sutura

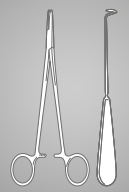

TC GOLD



1/2

Hegar-Vascular
20-658-14-07 -
20-658-23-07

| | | | |
|--------------------------------|----------------------------------|----------------------------------|----------------------------|
| | | | |
| 1/4 | | | |
| 20-658-14-07 14 cm / 5 4/8" | 20-658-18-07 18,5 cm / 7 3/8" | 20-658-20-07 20,5 cm / 8 1/8" | 20-658-23-07 23 cm / 9" |
| 5-0 - 8-0 | 5-0 - 8-0 | 5-0 - 8-0 | 5-0 - 8-0 |
| Micro | Micro | Micro | Micro |

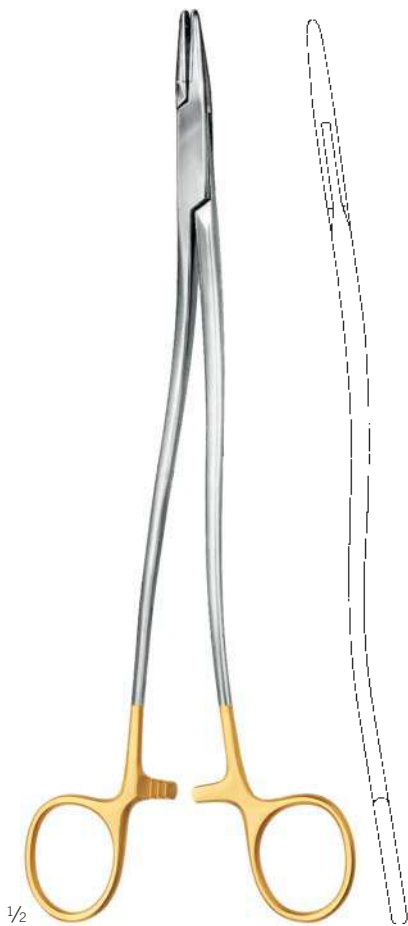

1/2

Bozemann
20-659-20-07 -
20-659-28-07

| | |
|----------------------------------|---------------------------------|
| | |
| 1/4 | |
| 20-659-20-07 20,5 cm / 8 1/8" | 20-659-24-07 24 cm / 9 4/8" |
| 0-6 - 4-0 | 0-6 - 4-0 |
| Standard | Standard |
| | |
| | |
| 20-659-26-07 26 cm / 10 4/8" | 20-659-28-07 30 cm / 11 6/8" |
| 0-6 - 4-0 | 0-6 - 4-0 |
| Standard | Standard |



1/2

Hegar
20-662-20-07 -
20-662-24-07

| | |
|--------------------------------|--------------------------------|
| | |
| 1/4 | |
| 20-662-20-07 20 cm / 7 7/8" | 20-662-24-07 24 cm / 9 4/8" |
| 0-6 - 4-0 | 0-6 - 4-0 |
| Standard | Standard |

20

Nadelhalter

Needle Holders

Porta-agujas

Porte-aiguilles

Portaghi

TC GOLD

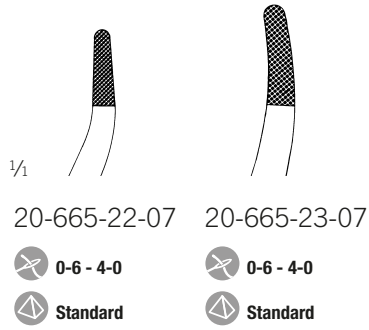
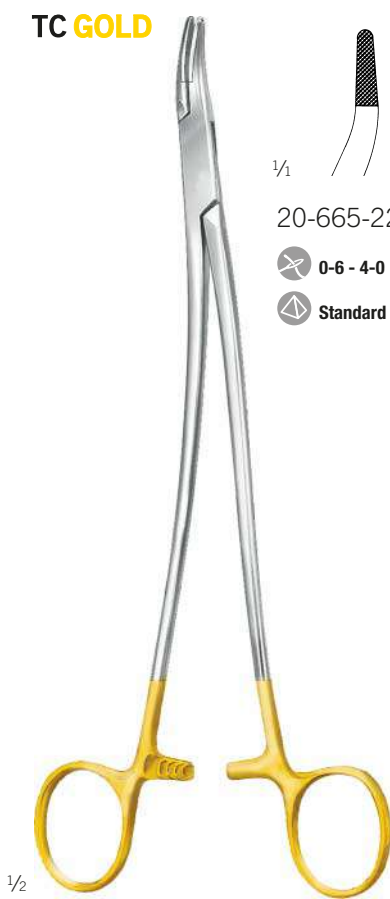

20-665-22-07

20-665-23-07

0-6 - 4-0

0-6 - 4-0

Standard

Standard

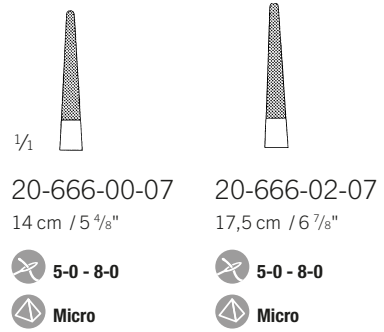

20-666-00-07

20-666-02-07

14 cm / 5 4/8"

17,5 cm / 6 7/8"

5-0 - 8-0

5-0 - 8-0

Micro

Micro

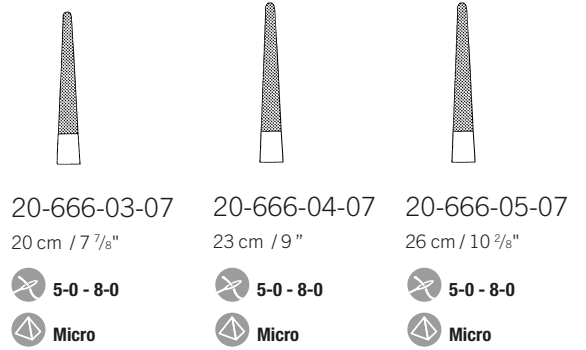

20-666-03-07

20-666-04-07

20-666-05-07

20 cm / 7 7/8"

23 cm / 9"

26 cm / 10 2/8"

5-0 - 8-0

5-0 - 8-0

5-0 - 8-0

Micro

Micro

Micro

Stratte
20-665-22-07 -
20-665-23-07
23 cm / 9"

Microvascular
20-666-00-07 -
20-666-05-07

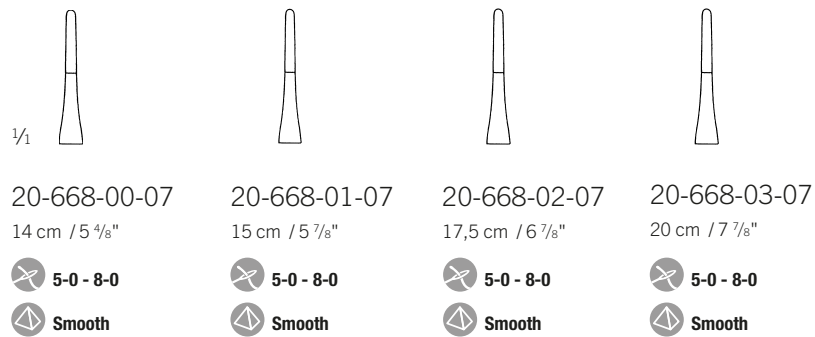

20-668-00-07

20-668-01-07

20-668-02-07

20-668-03-07

14 cm / 5 4/8"

15 cm / 5 7/8"

17,5 cm / 6 7/8"

20 cm / 7 7/8"

5-0 - 8-0

5-0 - 8-0

5-0 - 8-0

5-0 - 8-0

Smooth

Smooth

Smooth

Smooth

Martini
20-668-00-07 -
20-668-03-07

Nadelhalter

Needle Holders

Porta-agujas

Porte-aiguilles

Portaghi

Naht

Suture

Sutura

Suture

Sutura

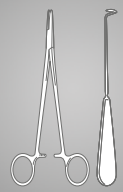

TC GOLD



1/2

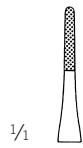

1/4

20-670-00-07

14 cm / 5 4/8"



5-0 - 8-0



Micro

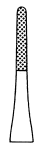

20-670-01-07

15 cm / 5 7/8"



5-0 - 8-0



Micro



20-670-02-07

17,5 cm / 6 7/8"



5-0 - 8-0



Micro



20-670-03-07

20 cm / 7 7/8"



5-0 - 8-0



Micro

Martini
20-670-00-07 -
20-670-03-07

schlankes Modell
delicate pattern
modelo delgado
modèle gracile
modelo gracile



1/2

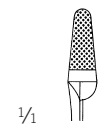

1/4

20-672-14-07

14,5 cm / 5 7/8"



0-6 - 4-0



Standard



20-672-17-07

17 cm / 6 5/8"



0-6 - 4-0



Standard



20-672-18-07

19 cm / 7 4/8"



0-6 - 4-0



Standard

Olsen Hegar
20-672-14-07 -
20-672-18-07

Normalprofil
standard profile
perfil estándar
profil normal
profilo normale

Nadelhalter

Needle Holders

Porta-agujas

Porte-aiguilles

Portaghi

TC GOLD

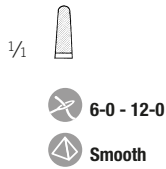

1/2

Foster-Gillies
20-673-12-07
11 cm / 4 3/8"



1/2

Gillies-Mini
20-673-15-07
15 cm / 5 7/8"

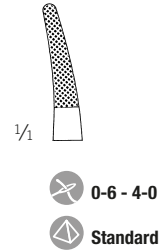

1/2

Gillies
20-673-16-07
16 cm / 6 2/8"



1/2

Mathieu
20-674-14-07 -
20-674-20-07

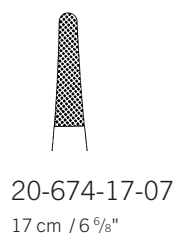
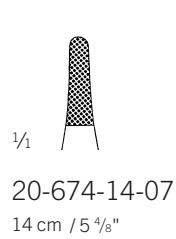

Nadelhalter

Needle Holders

Porta-agujas

Porte-aiguilles

Portaghi

Naht

Suture

Sutura

Suture

Sutura

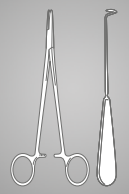

TC GOLD



1/2



1/4

20-676-14-07
14 cm / 5 4/8"



0-6 - 4-0



Standard



20-676-17-07
17 cm / 6 6/8"



0-6 - 4-0



Standard



20-676-20-07
20 cm / 7 7/8"



0-6 - 4-0



Standard

Mathieu
20-676-14-07 -
20-676-20-07



1/2

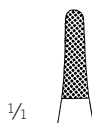

1/4

20-678-17-07
17 cm / 6 6/8"



0-6 - 4-0



Standard



20-678-20-07
20 cm / 7 7/8"



0-6 - 4-0



Standard

Mathieu
20-678-17-07 -
20-678-20-07
mit Innensperre
with interior ratchet
con cremallera interior
avec crémaillère interne
con cremagliera interna



1/2



1/4



0-6 - 4-0



Standard

Toennis
20-684-18-07
18 cm / 7 1/8"

20

Nadelhalter

Needle Holders

Porta-agujas

Porte-aiguilles

Portaghi

TC GOLD



0-6 - 4-0
Standard

1/2

Kübler
20-685-18-07
18 cm / 7 1/8"

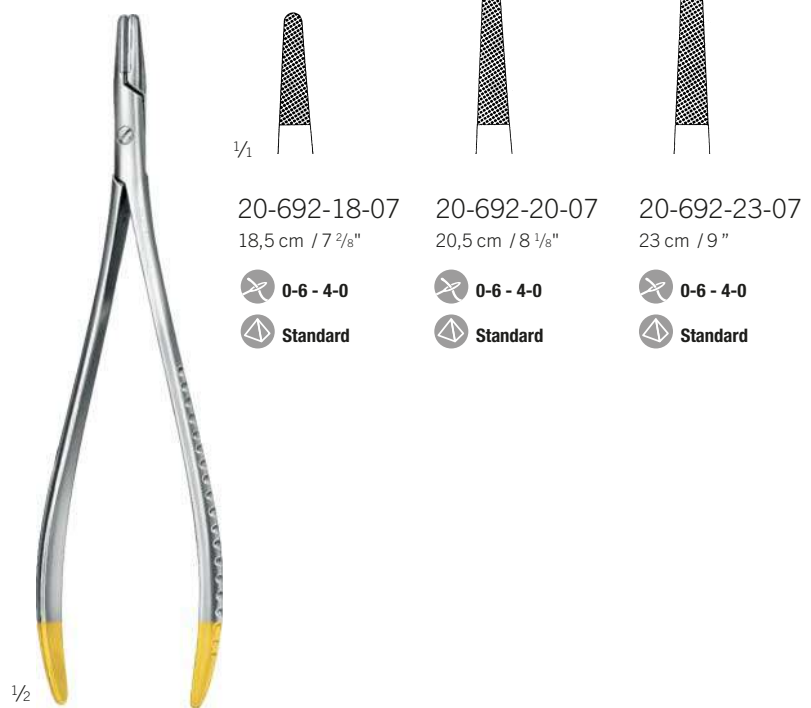

20-692-18-07
18,5 cm / 7 2/8"

0-6 - 4-0
Standard

1/2

Langenbeck
20-692-18-07 -
20-692-23-07

20-692-20-07
20,5 cm / 8 1/8"

0-6 - 4-0
Standard

20-692-23-07
23 cm / 9"

0-6 - 4-0
Standard

Unterbindungsnadeln

Ligature Needles
Agujas para ligaduras
Aiguilles à ligatures
Aghi per legatura

Naht
Suture
Sutura
Suture
Sutura

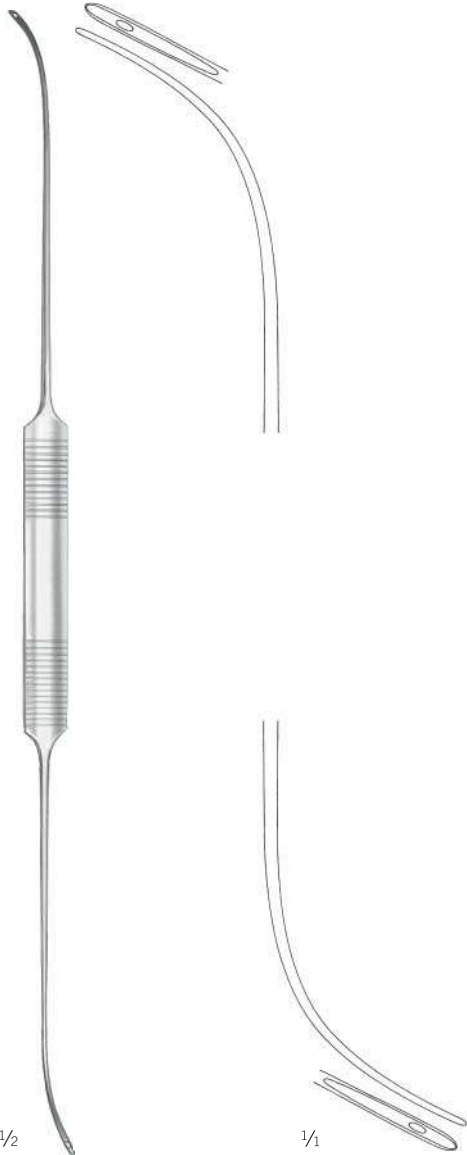
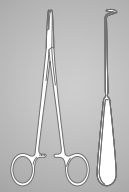

1/2

1/1

Schmieden-Dick
20-813-32-07

30 cm / 11 5/8"

biegsam
malleable
maleable
malléable
malleabili



1/2

1/1

Schmieden
20-815-21-07

24 cm / 9 4/8"

Unterbindungsnadeln

Ligature Needles

Agujas para ligaduras

Aiguilles à ligatures

Aghi per legatura



20-825-20-07

20 cm / 7 7/8"

biegsam
malleable
maleable
malléable
malleabili

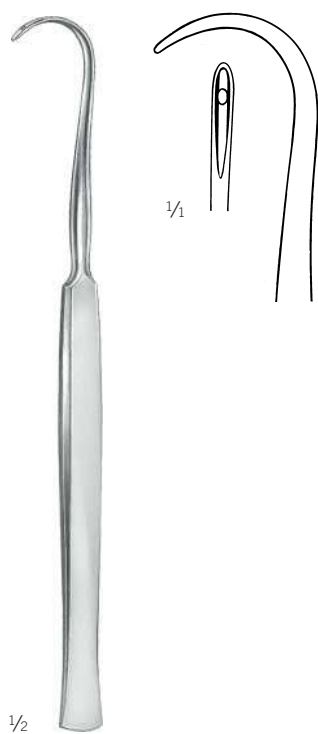

Cooper

20-832-19-07

20 cm / 7 7/8"

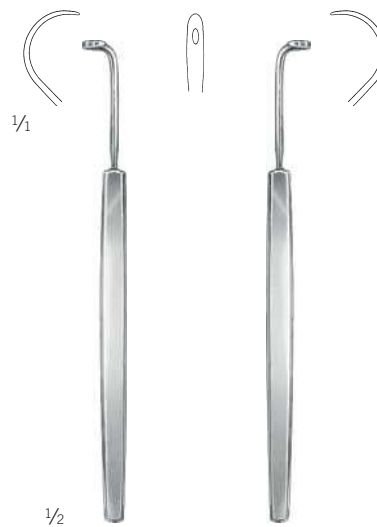

Kronecker

20-835-13-07

12 cm / 4 6/8"

fein, für die rechte Hand
delicate, for right hand
fina, para la mano derecha
fine, pour la main droite
fino, per la mano destra

Kronecker

20-837-13-07

12 cm / 4 6/8"

fein, für die linke Hand
delicate, for left hand
fina, para la mano izquierda
fine, pour la main gauche
fino, per la mano sinistra

Unterbindungsnadeln

Ligature Needles
 Agujas para ligaduras
 Aiguilles à ligatures
 Aghi per legatura

Naht
 Suture
 Sutura
 Suture
 Sutura



20-839-24-07
 24 cm / 9 4/8"
 stumpf, für die rechte Hand
 blunt, for right hand
 roma para la mano derecha
 mousse, pour la main droite
 smusso, per la mano destra

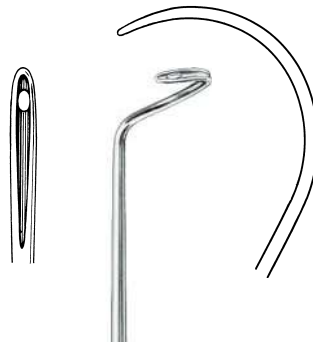

20-840-24-07
 24 cm / 9 4/8"
 stumpf, für die linke Hand
 blunt, for left hand
 roma para la mano izquierda
 mousse, pour la main gauche
 smusso, per la mano sinistra

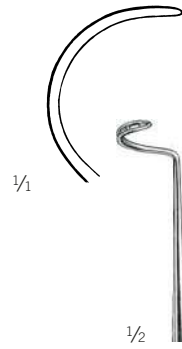

20-841-20-07
 20 cm / 7 7/8"
 stumpf, für die rechte Hand
 blunt, for right hand
 roma para la mano derecha
 mousse, pour la main droite
 smusso, per la mano destra



20-842-20-07
 20 cm / 7 7/8"
 stumpf, für die linke Hand
 blunt, for left hand
 roma para la mano izquierda
 mousse, pour la main gauche
 smusso, per la mano sinistra

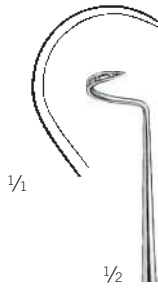

20-843-20-07
 20 cm / 7 7/8"
 scharf, für die rechte Hand
 sharp, for right hand
 aguda para la mano derecha
 aiguë, pour la main droite
 acuto, per la mano destra



20-844-20-07
 20 cm / 7 7/8"
 scharf, für die linke Hand
 sharp, for left hand
 aguda para la mano izquierda
 aiguë, pour la main gauche
 acuto, per la mano sinistra

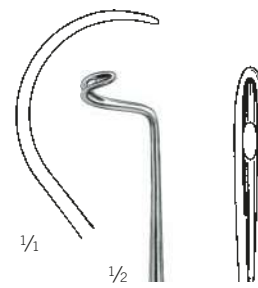

20-845-21-07
 20 cm / 7 7/8"
 stumpf, für die rechte Hand
 blunt, for right hand
 roma para la mano derecha
 mousse, pour la main droite
 smusso, per la mano destra



20-846-21-07
 20 cm / 7 7/8"
 stumpf, für die linke Hand
 blunt, for left hand
 roma para la mano izquierda
 mousse, pour la main gauche
 smusso, per la mano sinistra

1/2
 Deschamps
 20-839-24-07-
 20-860-20-07

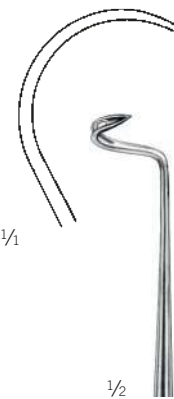

20-847-21-07
 20 cm / 7 7/8"
 scharf, für die rechte Hand
 sharp, for right hand
 aguda para la mano derecha
 aiguë, pour la main droite
 acuto, per la mano destra

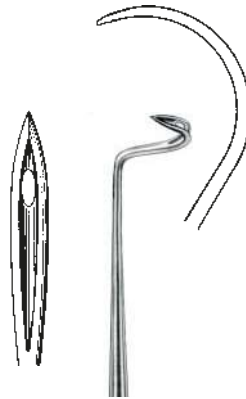

20-848-21-07
 20 cm / 7 7/8"
 scharf, für die linke Hand
 sharp, for left hand
 aguda para la mano izquierda
 aiguë, pour la main gauche
 acuto, per la mano sinistra

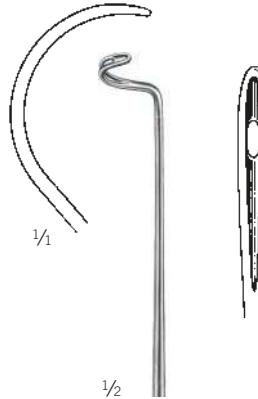

20-849-27-07
 27 cm / 10 5/8"
 stumpf, für die rechte Hand
 blunt, for right hand
 roma para la mano derecha
 mousse, pour la main droite
 smusso, per la mano destra

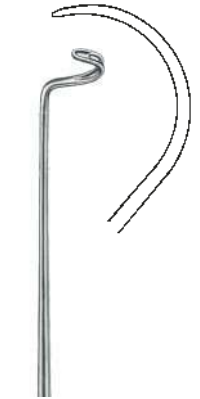

20-850-27-07
 27 cm / 10 5/8"
 stumpf, für die linke Hand
 blunt, for left hand
 roma para la mano izquierda
 mousse, pour la main gauche
 smusso, per la mano sinistra

20

Unterbindungsnadeln

Ligature Needles

Agujas para ligaduras

Aiguilles à ligatures

Aghi per legatura

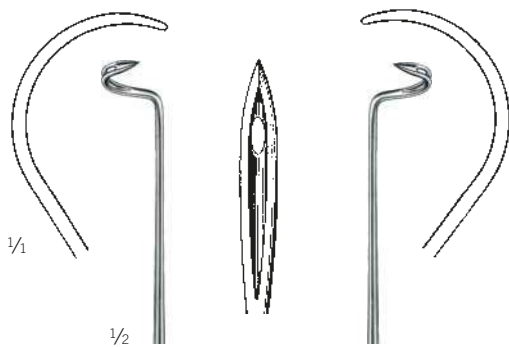

20-851-27-07

27 cm / 10 5/8"

scharf, für die rechte Hand
sharp, for right hand
aguda para la mano derecha
aiguë, pour la main droite
acuto, per la mano destra

20-852-27-07

27 cm / 10 5/8"

scharf, für die linke Hand
sharp, for left hand
aguda para la mano izquierda
aiguë, pour la main gauche
acuto, per la mano sinistra

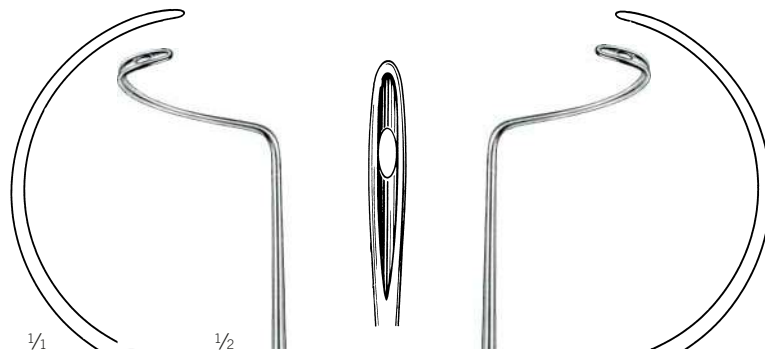

20-853-28-07

28 cm / 11"

stumpf, für die rechte Hand
blunt, for right hand
roma para la mano derecha
mousse, pour la main droite
smusso, per la mano destra

20-854-28-07

28 cm / 11"

stumpf, für die linke Hand
blunt, for left hand
roma para la mano izquierda
mousse, pour la main gauche
smusso, per la mano sinistra

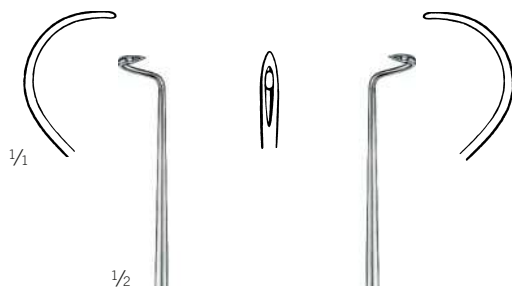

20-855-20-07

21 cm / 8 2/8"

scharf, für die rechte Hand
sharp, for right hand
aguda para la mano derecha
aiguë, pour la main droite
acuto, per la mano destra

20-856-20-07

21 cm / 8 2/8"

scharf, für die linke Hand
sharp, for left hand
aguda para la mano izquierda
aiguë, pour la main gauche
acuto, per la mano sinistra

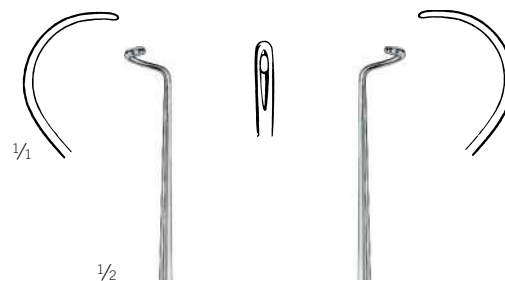

20-857-20-07

21 cm / 8 2/8"

stumpf, für die rechte Hand
blunt, for right hand
roma para la mano derecha
mousse, pour la main droite
smusso, per la mano destra

20-858-20-07

21 cm / 8 2/8"

stumpf, für die linke Hand
blunt, for left hand
roma para la mano izquierda
mousse, pour la main gauche
smusso, per la mano sinistra

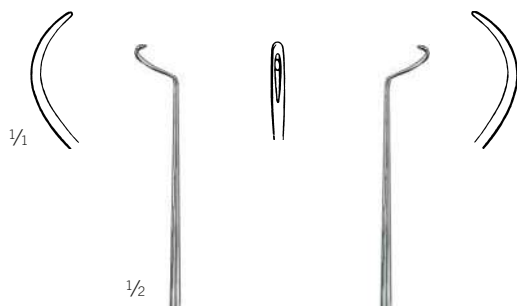

20-859-20-07

21 cm / 8 2/8"

stumpf, für die rechte Hand
blunt, for right hand
roma para la mano derecha
mousse, pour la main droite
smusso, per la mano destra

20-860-20-07

21 cm / 8 2/8"

stumpf, für die linke Hand
blunt, for left hand
roma para la mano izquierda
mousse, pour la main gauche
smusso, per la mano sinistra

Unterbindungsnadeln, Führungshohlsonden

Ligature Needles, Ligature Conductors
Agujas para ligaduras, Sondas conductoras
Aiguilles à ligatures, Sondes conductrices
Aghi per legatura, Sonde conduttrici

Naht
Suture
Sutura
Suture
Sutura



1/2

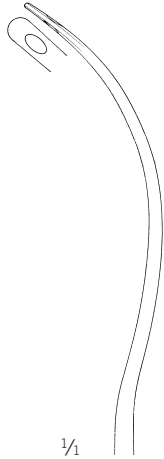

1/4

Fig. 1
20-861-30-07

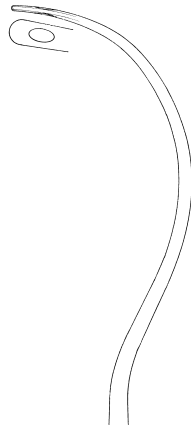

Fig. 2
20-862-30-07

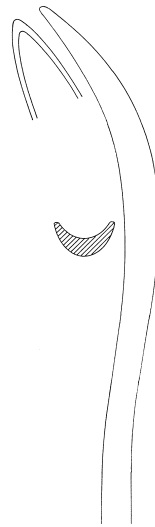

Fig. 1
20-863-30-07

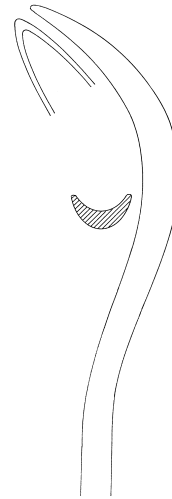
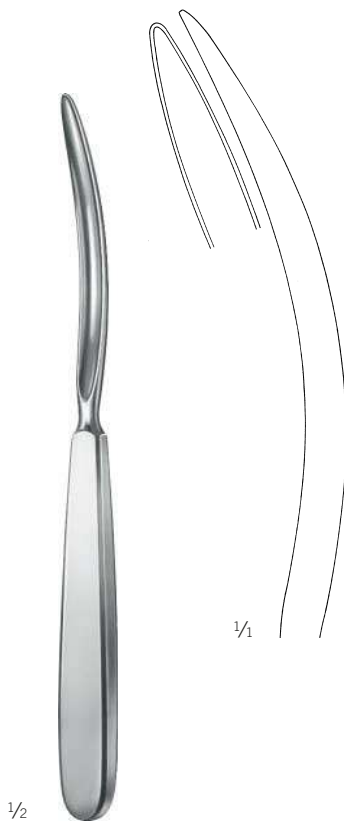

Fig. 2
20-864-30-07

Brunner
20-861-30-07 -
20-864-30-07
30 cm / 11 6/8"

Führungshohlsonden

Ligature Conductors
Sondas conductoras
Sondes conductrices
Sonde conduttrici



Mod. Martin
20-867-25-07
19,5 cm / 7 5/8"

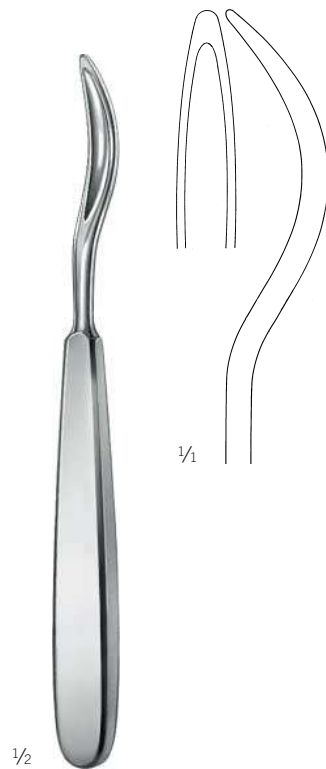

Schmieden
20-871-19-07
18 cm / 7 1/8"



Schmieden-Payr
20-872-19-07
18 cm / 7 1/8"

Führungshohlsonden

Ligature Conductors
Sondas conductoras
Sondes conductrices
Sonde conduttrici

Naht
Suture
Sutura
Suture
Sutura

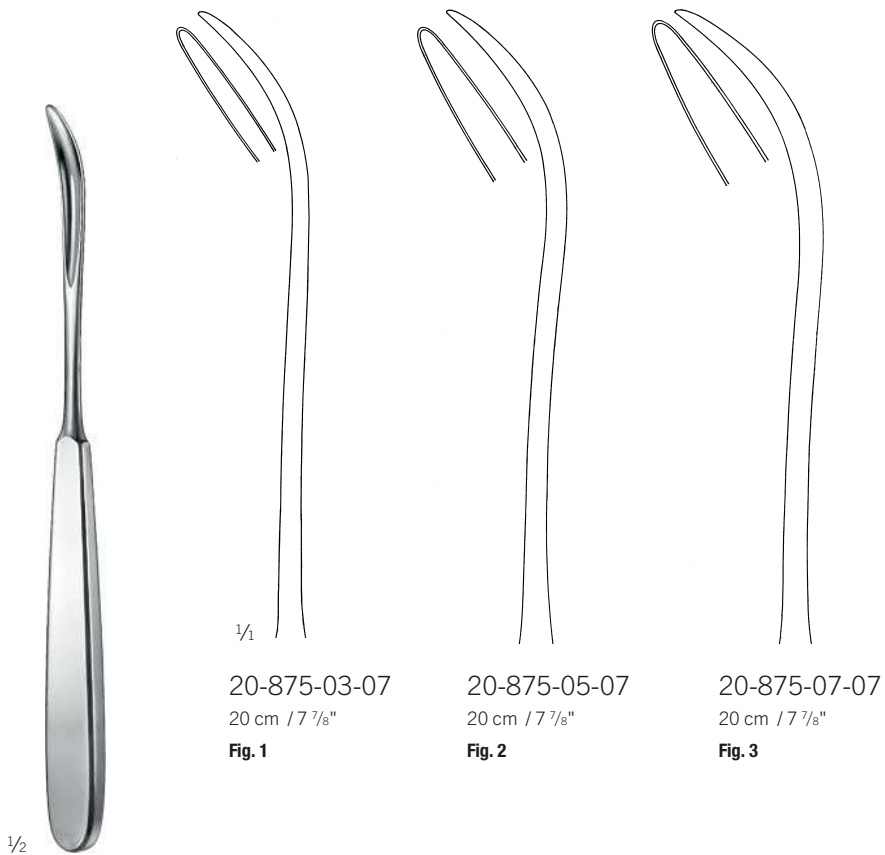
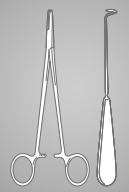

König
20-875-03-07 -
20-875-07-07

20

Führungshohlsonden, Fadenfänger, Fadengabel, Fadenpinzette

Ligature Conductors, Ligature Catcher, Ligature Adjuster, Thread forceps

Sondas conductoras, Captador de hilos, Horquilla de hilos, Pinzas para ligaduras

Sondes conductrices, Porte-ligature, Pousse-fil, Pince à fil

Sonde conduttrici, Portalegature, Forchetta da sutura, Pinze porta-filo

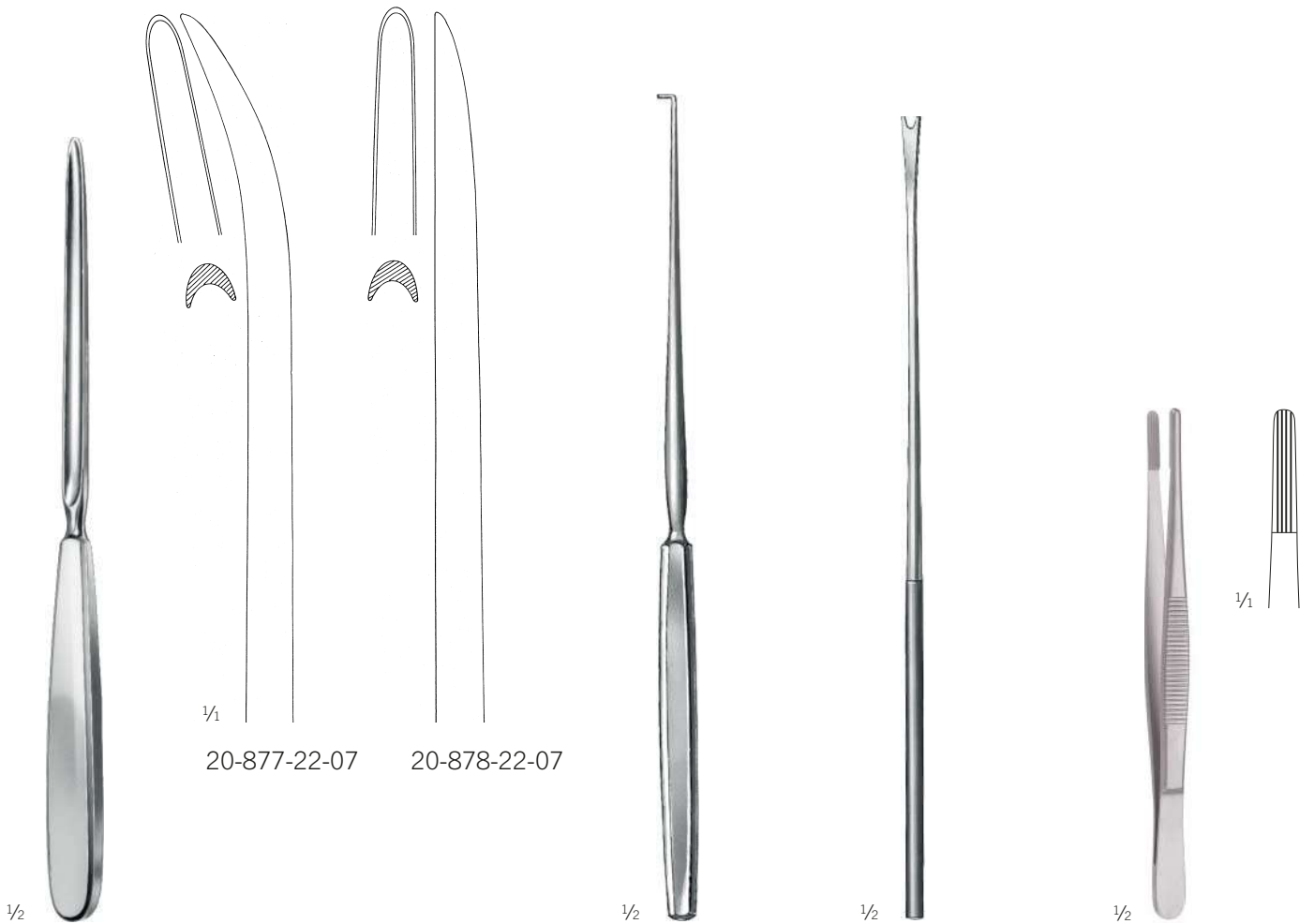

Payr
20-877-22-07 -
20-878-22-07
22 cm / 8⁵/₈"

Modell Wien
20-882-23-07
23,5 cm / 9²/₈"
Fadenfänger
Ligature Catcher
Captador de hilos
Porte-ligature
Portalegature

20-886-23-07
23 cm / 9"
Fadengabel
Ligature Adjuster
Horquilla de hilos
Pousse-fil
Forchetta da sutura

Ochsner
20-894-14-07
14,5 cm / 5⁶/₈"
Fadenpinzette
Thread forceps
Pinzas para ligaduras
Pince à fil
Pinze porta-filo

Wundklammerpinzetten

Clip Applying Forceps
Pinzas aplicadoras para agrafes
Pincas à poser les agrafes
Pinze per applicare le agrafe

Naht

Suture
Sutura
Suture
Sutura

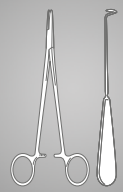

1/2

Childe
20-910-18-07
17 cm / 6 5/8"

Wundrandpinzette
Approximation Forceps
Pinza aproximadora
Pincas à poser les agrafes
Pinza per i margini della ferita
kräftig, mit Klammerschiene
heavy pattern, with clip holder
modelo fuerte, con barra para agrafes
modèle fort, avec porte-agraves
modello forte, con portaagrades



1/2

Michel
20-916-12-07
12 cm / 4 5/8"



1/2

Hegenbarth
20-922-12-07
12 cm / 4 5/8"



1/2

Wachenfeldt
20-924-12-07
12 cm / 4 5/8"

Wundklammerzängchen

Clip Applying Forceps

Pinzas aplicadoras para agrafes

Pinces à poser les agrafes

Pinze per applicare le agrafe



Michel
20-928-12-07

12,5 cm / 4 7/8"

zum Anlegen und Abnehmen von Klammern
for applying and removal of clips
para aplicar y quitar agrafes
pour appliquer et enlever les agrafes
per applicare e togliere le agrafes



Michel
20-929-12-07

13 cm / 4"

langes Maul, zum Anlegen und Abnehmen
von Klammern
long jaw, for applying and removal of clips
boca larga, para aplicar y quitar agrafes
pour appliquer et enlever les agrafes
morso lungo, per applicare e togliere
le agrafes



Richter
20-935-14-07

13,5 cm / 5 3/8"

mit Schraubschluß
screw lock
articulación a tornillo
articulation à vis
articulazione a vite