

Arterienklemmen
Haemostatic Forceps
Pinzas hemostáticas
Pincès hémostatiques
Pinze emostatiche

13

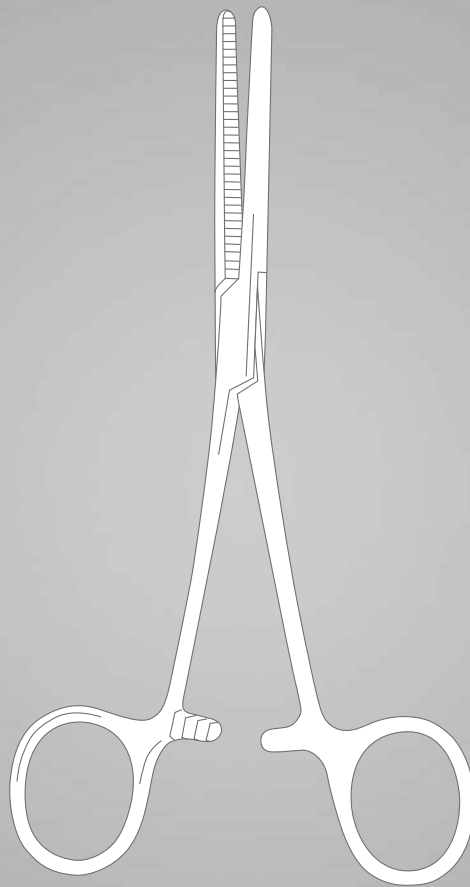

Clip-Anlegepinzette, Gefäßclips

Clip Applying Forceps, Vessel Clips

Pinzas para aplicar clips,

Pinces pour poser les clips vasculaires, Clips vasculaires

Pinze per applicazione clips vascolari,



Biemer
13-010-00-07
16 cm / 6 2/8"
Gefäßspreizer
Vascular spreader
Dilatador de vasos
Ecarteur vasculaire
Dilatatore vascolare



13-050-14-07
14,5 cm / 5 5/8"
ohne Sperre
w/o ratchet
sin cremallera
sans cremaillère
senza cremagliera

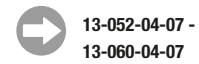

13-051-14-07
14,5 cm / 5 5/8"
mit Sperre
with ratchet
con cremallera
avec cremaillère
con cremagliera



Biemer
13-052-04-07 -
13-053-05-07



St	13-052-04-07	13-052-05-07	13-053-05-07
	14 mm	17 mm	17 mm
	6 mm	9 mm	9 mm
	4 mm	7 mm	7 mm
P	30 - 40 g	30 - 40 g	20 - 25 g

Gefäßclips, Approximatoren

Vessel Clips, Approximators
Clips vasculares, Aproximadores
Clips vasculaires, Approximateurs
Clip vascolari, Approssimatori

Arterienklemmen

Haemostatic Forceps
Pinzas hemostáticas
Pincas hémostatiques
Pinze emostatiche



Biemer-Müller
13-054-05-07 -
13-059-05-07

13



	gerade, breit straight, wide recto, ancho droit, large retto, largo	gewinkelt, breit angled, wide angulado, ancho coudé, large angulato, largo	gerade, schmal straight, narrow recto, estrecho droit, étroit retto, stretto	gerade, schmal straight, narrow recto, estrecho droit, étroit retto, stretto	gewinkelt, schmal angled, narrow angulado, estrecho coudé, étroit angulato, stretto
St	13-054-05-07	13-055-05-07	13-056-03-07	13-058-05-07	13-059-05-07
	17 mm	17 mm	13 mm	17 mm	17 mm
	9 mm	9 mm	4,5 mm	9 mm	9 mm
	7 mm	7 mm	4 mm	7 mm	7 mm
P	30 - 40 g	30 - 40 g	30 - 40 g	30 - 40 g	25 - 30 g

Approximatoren

Approximators

Aproximadores

Approximateurs

Approssimatori

für Mikro-Gefäß Anastomosen in der Tiefe
for Micro vessel anastomosis in the depth
para micro anastomosis en la profundidad
pour micro-anastomoses vasculaires en profondeur
per micro-anastomosi vascolari nella profondità



1/1

13-062-00-07

komplett mit Schlüssel
complete with key
completo con llave
complet avec clef
completti con chiave



1/1



1/1

13-062-01-07

Schlüssel für Approximator
Key for Approximator
Llave para aproximador
Clef pour approximateur
Chiave per approssimatore



13-062-02-07



1/1

13-062-02-07

Approximator, allein
Approximator, only
Aproximador, suelto
Approximateur, seul
Approssimatore, solo

Mini-Gefäßclips, Clip-Anlegezangen, Bulldogklemmen

Mini Vessel Clips, Clip Applying Forceps

Mini Clips vasculaires, Pinzas para aplicar clips

Micro-clips vasculaires, Pincettes pour poser micro-clips

Mini-clip vascolari, Pinze per applicare clips vascolari

Arterienklemmen

Haemostatic Forceps

Pinzas hemostáticas

Pincettes hémostatiques

Pinze emostatiche



1/2



13-102-04-07 -
13-102-10-07

13-104-14-07

14,5 cm / 5 7/8"

mit Sperre
with ratchet
con cremallera
avec cremaillère
con cremagliera



1/2



13-102-04-07 -
13-102-10-07

13-106-18-07

18,5 cm / 7 3/8"

mit Sperre
with ratchet
con cremallera
avec cremaillère
con cremagliera

1/4



1/4

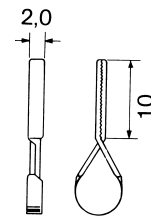
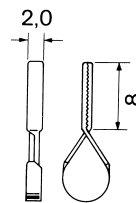
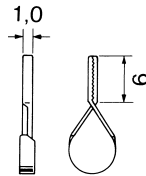
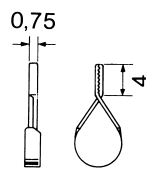

13-102-04-07 -
13-102-10-07

St	13-102-04-07	13-102-06-07	13-102-08-07	13-102-10-07
	1,3 cm	1,5 cm	1,7 cm	2,0 cm
	4 mm	6 mm	8 mm	10 mm
	4 mm	5 mm	6 mm	7 mm
	60 g	85 g	100 g	125 g

Bulldogklemmen

Bulldog Clamps

Clamps Bulldog

Clamps Bulldog

Pinze Bulldog



1/2

13-108-10-07 -
13-109-18-07

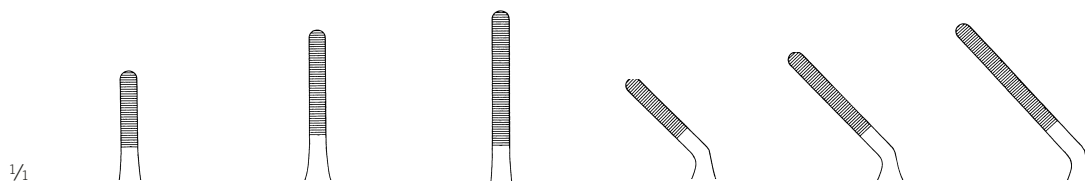

1/4

St	13-108-10-07	13-108-14-07	13-108-18-07	13-109-10-07	13-109-14-07	13-109-18-07
	3,1 cm	3,5 cm	3,9 cm	3,0 cm	3,3 cm	3,6 cm
	10 mm	14 mm	18 mm	10 mm	14 mm	18 mm
	30 g	30 g	30 g	30 g	30 g	30 g



1/2

Dieffenbach
13-110-06-07 -
13-115-05-07

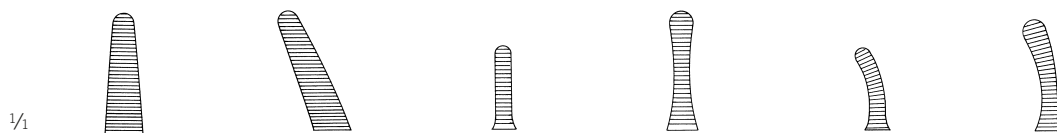

1/4

St	13-110-06-07	13-111-06-07	13-114-03-07	13-114-05-07	13-115-03-07	13-115-05-07
	6 cm / 2 3/8"	6 cm / 2 3/8"	3,5 cm / 1 3/8"	5 cm / 2"	3,5 cm / 1 3/8"	5 cm / 2"
	17 mm	17 mm	11 mm	15 mm	11 mm	15 mm

Bulldogklemmen

Bulldog Clamps
Clamps Bulldog
Clamps Bulldog
Pinze Bulldog

Arterienklemmen

Haemostatic Forceps
Pinzas hemostáticas
Pincas hémostatiques
Pinze emostatiche



1/2

Johns-Hopkins
13-115-38-07 -
13-115-90-07

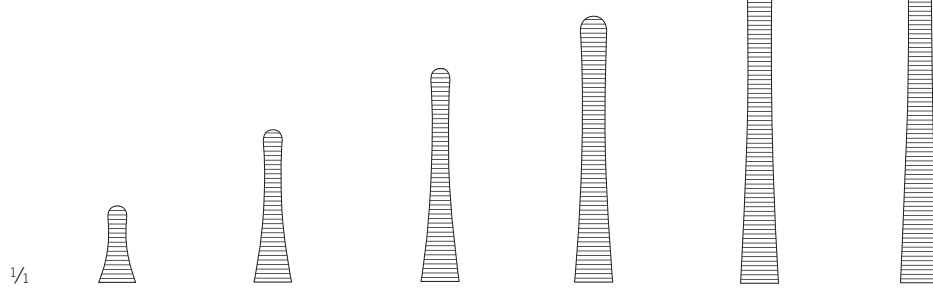

1/1

St	13-115-38-07	13-115-45-07	13-115-55-07	13-115-65-07	13-115-75-07	13-115-90-07
	3,8 cm / 1 3/8"	4,5 cm / 1 6/8"	5,5 cm / 2 1/8"	6,5 cm / 2 4/8"	7,5 cm / 3"	9 cm / 3 4/8"
	12 mm	17 mm	25 mm	30 mm	40 mm	50 mm
P	300 g	300 g	300 g	300 g	300 g	300 g



1/2

Johns-Hopkins
13-116-38-07 -
13-116-90-07

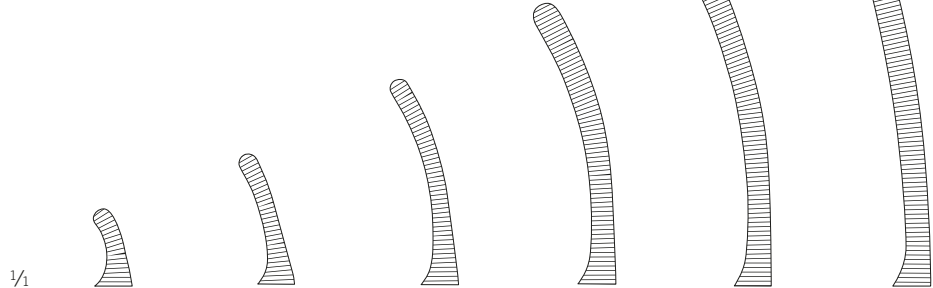

1/1

St	13-116-38-07	13-116-45-07	13-116-55-07	13-116-65-07	13-116-75-07	13-116-90-07
	3,8 cm / 1 4/8"	4,5 cm / 1 6/8"	5,5 cm / 2 1/8"	6,5 cm / 2 4/8"	7,5 cm / 3"	9 cm / 3 4/8"
	12 mm	17 mm	25 mm	30 mm	40 mm	50 mm
P	300 g	300 g	300 g	300 g	300 g	300 g

Bulldogklemmen

Bulldog Clamps

Clamps Bulldog

Clamps Bulldog

Pinze Bulldog



Diethrich
13-120-08-07 -
13-121-12-07

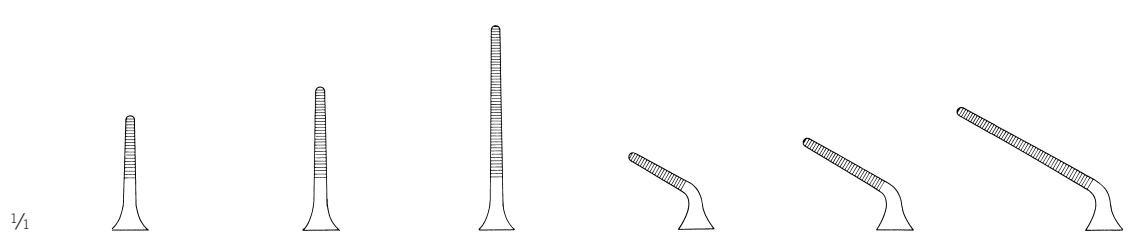

St	13-120-08-07	13-120-10-07	13-120-12-07	13-121-08-07	13-121-10-07	13-121-12-07
	4,5 cm / 11 ⁷ / ₁₆ "	5,0 cm / 12 ¹¹ / ₁₆ "	6,0 cm / 2 ³ / ₈ "	4,0 cm / 10 ³ / ₁₆ "	4,5 cm / 11 ⁷ / ₁₆ "	5,0 cm / 12 ¹¹ / ₁₆ "
	8 mm	12 mm	20 mm	8 mm	12 mm	20 mm
P	50 g	50 g	50 g	50 g	50 g	50 g

Atrauma

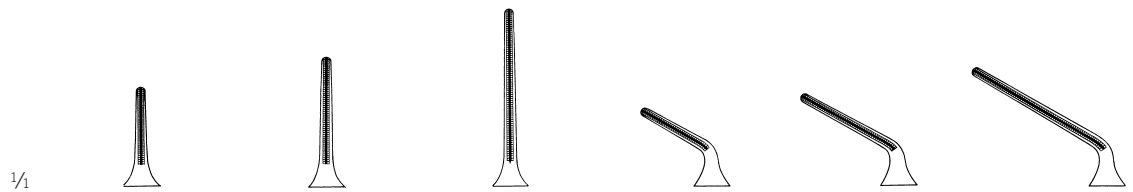

St	13-122-10-07	13-122-14-07	13-122-20-07	13-123-10-07	13-123-14-07	13-123-20-07
	4,5 cm / 11 ⁷ / ₁₆ "	5,0 cm / 12 ¹¹ / ₁₆ "	6,0 cm / 15 ⁴ / ₁₆ "	3,5 cm / 8 ¹⁴ / ₁₆ "	4,5 cm / 11 ⁷ / ₁₆ "	5,0 cm / 12 ¹¹ / ₁₆ "
	10 mm	14 mm	20 mm	10 mm	14 mm	20 mm
P	180 g	180 g	180 g	180 g	180 g	180 g



DeBakey-Diethrich
13-122-10-07 -
13-125-20-07

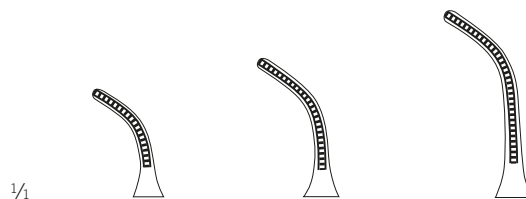

St	13-125-10-07	13-125-14-07	13-125-20-07
	3,5 cm / 8 ¹⁴ / ₁₆ "	4,5 cm / 11 ⁷ / ₁₆ "	5,0 cm / 12 ¹¹ / ₁₆ "
	10 mm	14 mm	20 mm
P	180 g	180 g	180 g

Bulldogklemmen

Bulldog Clamps
Clamps Bulldog
Clamps Bulldog
Pinze Bulldog

Arterienklemmen

Haemostatic Forceps
Pinzas hemostáticas
Pincas hémostatiques
Pinze emostatiche



Atrauma

1/1



1/1

Mini-Glover
13-132-30-09 -
13-142-50-09

Vena				
Ti	13-132-30-09	13-132-35-09	13-132-40-09	13-132-50-09
	3,0 cm / 7 ¹⁰ / ₁₆ "	3,5 cm / 8 ¹⁴ / ₁₆ "	4,0 cm / 10 ³ / ₁₆ "	5,0 cm / 12 ¹¹ / ₁₆ "
	9 mm	13 mm	14 mm	23 mm
P	110 g ⁺⁴⁰ / ₋₀ g	110 g ⁺⁴⁰ / ₋₀ g	110 g ⁺⁴⁰ / ₋₀ g	110 g ⁺⁴⁰ / ₋₀ g

Arteria				
Ti	13-142-30-09	13-142-35-09	13-142-40-09	13-142-50-09
	3,0 cm / 7 ¹⁰ / ₁₆ "	3,5 cm / 8 ¹⁴ / ₁₆ "	4,0 cm / 10 ³ / ₁₆ "	5,0 cm / 12 ¹¹ / ₁₆ "
	9 mm	13 mm	14 mm	23 mm
P	220 g ⁺⁶⁰ / ₋₀ g	220 g ⁺⁶⁰ / ₋₀ g	220 g ⁺⁶⁰ / ₋₀ g	220 g ⁺⁶⁰ / ₋₀ g

Atrauma

1/1



1/1

Mini-Glover
13-133-30-09 -
13-143-50-09

Vena				
Ti	13-133-30-09	13-133-35-09	13-133-40-09	13-133-50-09
	3,0 cm / 7 ¹⁰ / ₁₆ "	3,5 cm / 8 ¹⁴ / ₁₆ "	4,0 cm / 10 ³ / ₁₆ "	5,0 cm / 12 ¹¹ / ₁₆ "
	9 mm	13 mm	14 mm	23 mm
P	110 g ⁺⁴⁰ / ₋₀ g	110 g ⁺⁴⁰ / ₋₀ g	110 g ⁺⁴⁰ / ₋₀ g	110 g ⁺⁴⁰ / ₋₀ g

Arteria				
Ti	13-143-30-09	13-143-35-09	13-143-40-09	13-143-50-09
	3,0 cm / 7 ¹⁰ / ₁₆ "	3,5 cm / 8 ¹⁴ / ₁₆ "	4,0 cm / 10 ³ / ₁₆ "	5,0 cm / 12 ¹¹ / ₁₆ "
	9 mm	13 mm	14 mm	23 mm
P	220 g ⁺⁶⁰ / ₋₀ g	220 g ⁺⁶⁰ / ₋₀ g	220 g ⁺⁶⁰ / ₋₀ g	220 g ⁺⁶⁰ / ₋₀ g

Bulldogklemmen

Bulldog Clamps
Clamps Bulldog
Clamps Bulldog
Pinze Bulldog

Atrauma

1/1

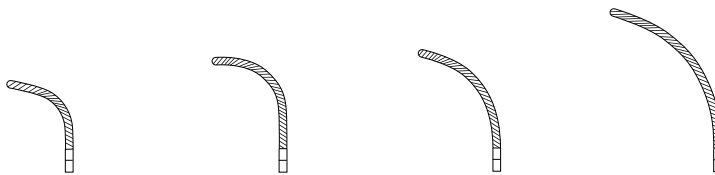

Vena				
Ti	13-135-30-09	13-135-35-09	13-135-40-09	13-135-50-09
	3,0 cm / 7 ¹⁰ / ₁₆ "	3,5 cm / 8 ¹⁴ / ₁₆ "	4,0 cm / 10 ³ / ₁₆ "	5,0 cm / 12 ¹¹ / ₁₆ "
	9 mm	13 mm	14 mm	23 mm
P	110 g ⁺⁴⁰ / ₋₀ g	110 g ⁺⁴⁰ / ₋₀ g	110 g ⁺⁴⁰ / ₋₀ g	110 g ⁺⁴⁰ / ₋₀ g

1/1



Mini-Glover
13-135-30-09 -
13-145-50-09

Arteria				
Ti	13-145-30-09	13-145-35-09	13-145-40-09	13-145-50-09
	3,0 cm / 7 ¹⁰ / ₁₆ "	3,5 cm / 8 ¹⁴ / ₁₆ "	4,0 cm / 10 ³ / ₁₆ "	5,0 cm / 12 ¹¹ / ₁₆ "
	9 mm	13 mm	14 mm	23 mm
P	220 g ⁺⁶⁰ / ₋₀ g	220 g ⁺⁶⁰ / ₋₀ g	220 g ⁺⁶⁰ / ₋₀ g	220 g ⁺⁶⁰ / ₋₀ g



Mini-Glover
13-131-24-07
24 cm / 9 ⁴/₈"

Anlegezange für Bulldogklemmen, Mini-Glover
Applying Forceps for Bulldog clamps, Mini-Glover
Pinza aplicadora para clamps bulldog, Mini-Glover
Pince pour poser les clamps Bulldog, Mini-Glover
Pinza per posizionare le pinze Bulldog, Mini-Glover

Arterienklemmen

Haemostatic Forceps
Pinzas hemostáticas
Pincas hémostatiques
Pinze emostatiche

Arterienklemmen

Haemostatic Forceps
Pinzas hemostáticas
Pincas hémostatiques
Pinze emostatiche



1/2

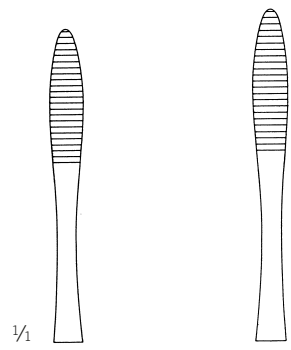

13-176-14-07 13-176-16-07
14,5 cm / 5 9/16" 16 cm / 6 2/8"

Pean
13-176-14-07 -
13-176-16-07



1/2

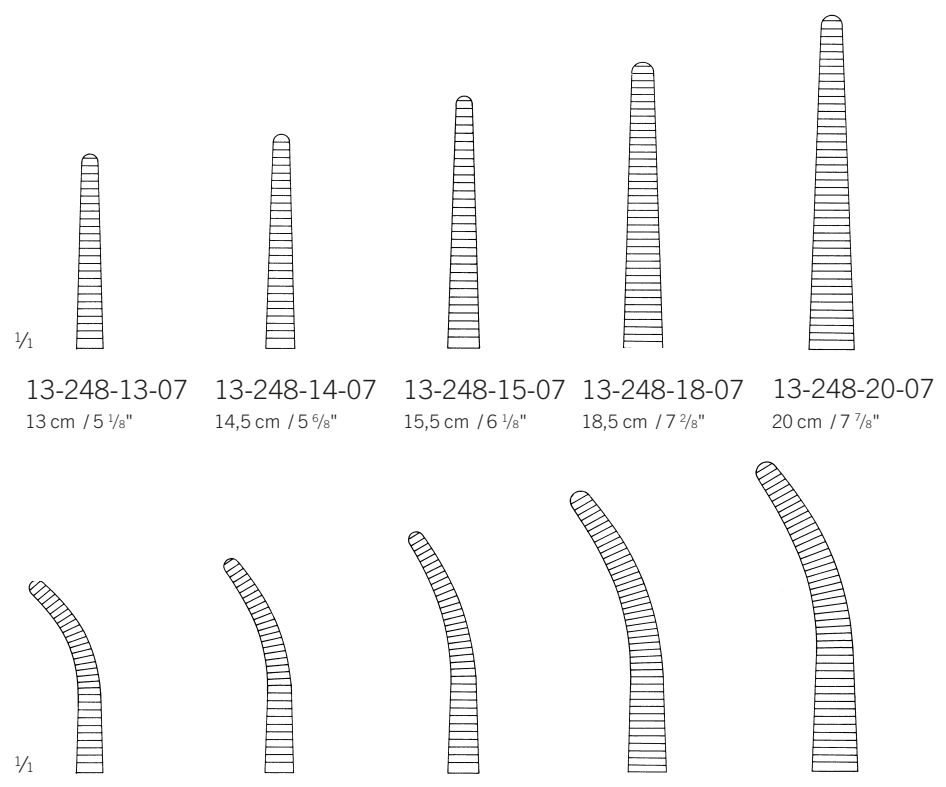

13-248-13-07 13-248-14-07 13-248-15-07 13-248-18-07 13-248-20-07
13 cm / 5 1/8" 14,5 cm / 5 9/16" 15,5 cm / 6 1/8" 18,5 cm / 7 3/8" 20 cm / 7 7/8"

13-249-13-07 13-249-14-07 13-249-15-07 13-249-18-07 13-249-20-07
13 cm / 5 1/8" 14 cm / 5 4/8" 15 cm / 5 7/8" 18 cm / 7 1/8" 20 cm / 7 7/8"

Spencer-Wells
13-248-13-07 -
13-249-20-07

Arterienklemmen, Organfasszangen

Haemostatic Forceps, Organ Grasping Forceps
 Pinzas hemostáticas, Pinzas para sacar órganos
 Pinces hémostatiques, Pinces pour saisir organes
 Pinze emostatiche, Pinze per afferrare organi



Chaput
 13-256-13-07
 12,5 cm / 4 7/8"



Tuffier
 13-258-13-07
 12,5 cm / 4 7/8"

Atrauma

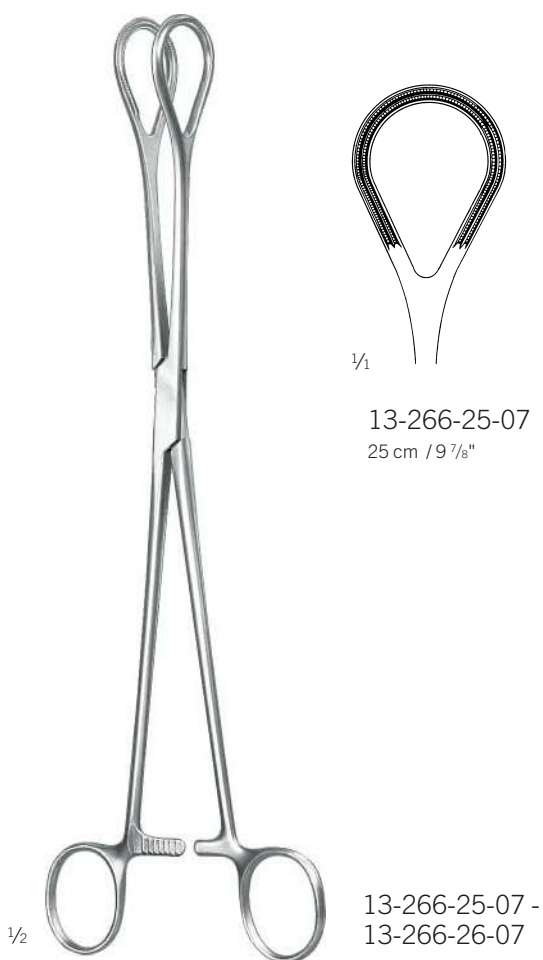

13-266-25-07
 25 cm / 9 7/8"

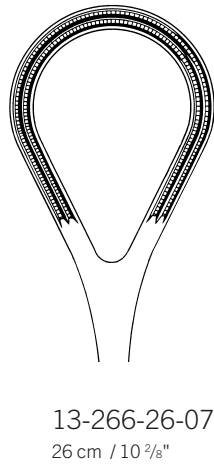

13-266-26-07
 26 cm / 10 2/8"

13-266-25-07 -
 13-266-26-07

Organfasszangen

Organ Grasping Forceps
Pinzas para sacar órganos
Pincas pour saisir organes
Pinze per afferrare organi

Arterienklemmen

Haemostatic Forceps
Pinzas hemostáticas
Pincas hémostatiques
Pinze emostatiche

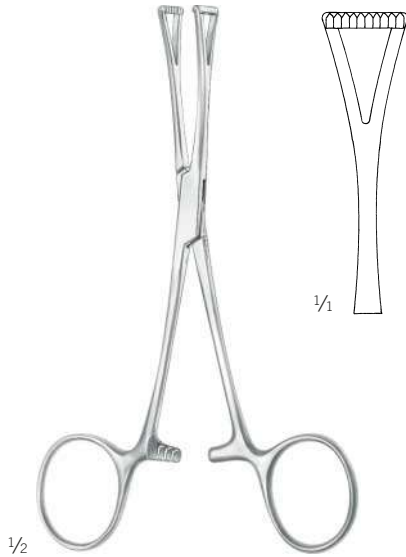

Collin
13-268-14-07
14 cm / 5 5/8"

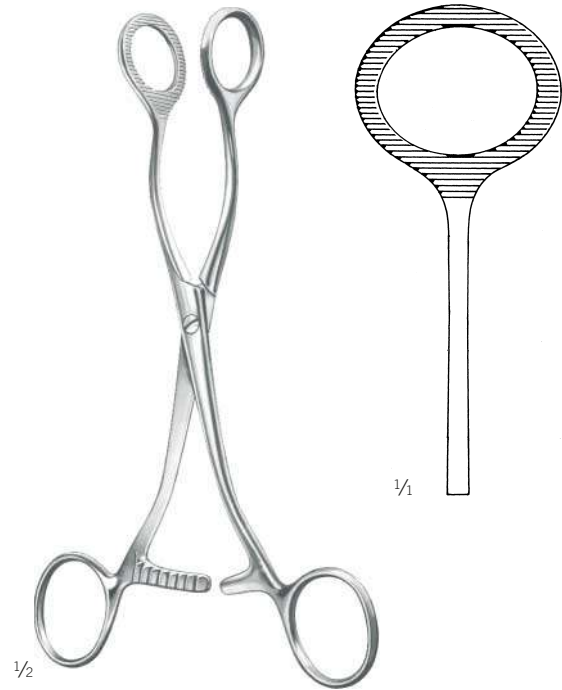

Collin
13-278-17-07
17 cm / 6 5/8"

Tumorfasszange
Tumor Grasping Forceps
Pinzas para sacar órganos
Pincas à tumeurs à vis
Pinze per afferrare tumori



Pennington
13-280-15-07 -
13-280-20-07

13-280-15-07
15,5 cm / 6 1/8"

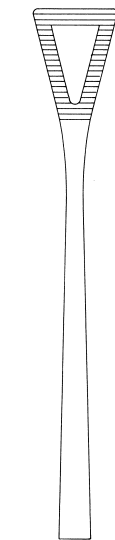

13-280-20-07
21 cm / 8 2/8"

Arterienklemmen, Präparierklemmen

Haemostatic Forceps, Dissecting and Ligature Forceps

Pinzas hemostáticas, Pinzas para preparación y ligadura

Pinces hémostatiques, Pinces à dissecquer et à ligatures

Pinze emostatiche, Pinze per preparazioni e legature

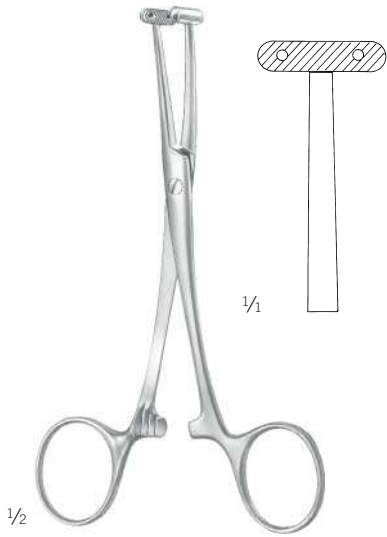

Martel-Rees
13-290-14-07

13,5 cm / 5 3/8"
Face-lift-Klemme
Face-lift Forceps
Pinza para Face-lift
Pinces pour Face-lift
Pinze per Face-lift



Mixer-Baby
13-303-01-07 -
13-303-02-07

13-303-01-07 13-303-02-07
13,5 cm / 5 3/8" 13 cm / 5 1/8"



Mikro-Adson
13-304-14-07

14 cm / 5 1/2"



Baby-Adson
13-305-18-07

18 cm / 7 1/8"

Arterienklemmen

Haemostatic Forceps
Pinzas hemostáticas
Pincas hémostatiques
Pinze emostatiche

Arterienklemmen

Haemostatic Forceps
Pinzas hemostáticas
Pincas hémostatiques
Pinze emostatiche

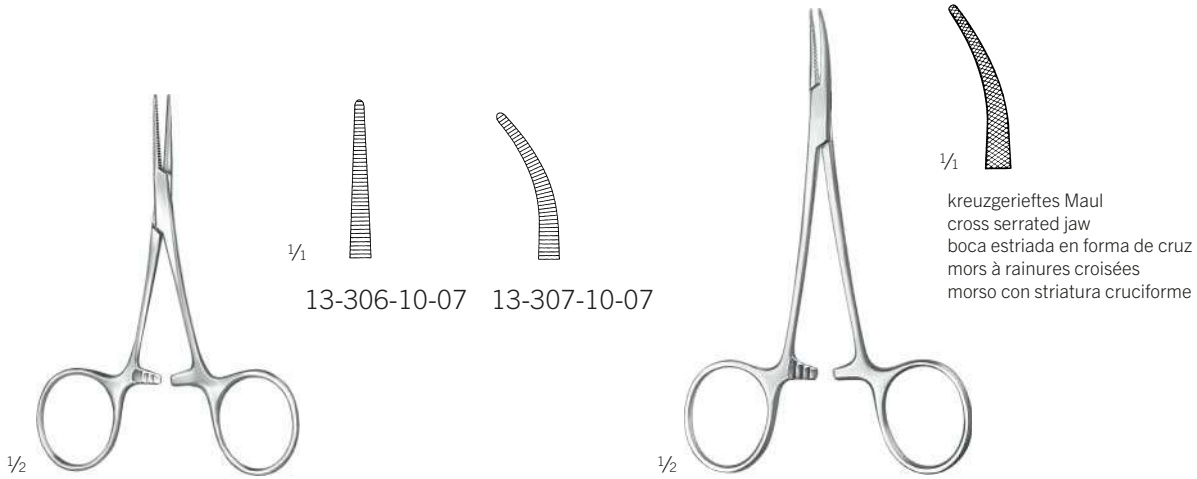

Hartmann
13-306-10-07 -
13-307-10-07
10 cm / 3 7/8"

13-309-12-07
12 cm / 4 5/8"
Fadenklemme
Ligature Forceps
Pinza para hilos
Pince à ligatures
Pinza per legature

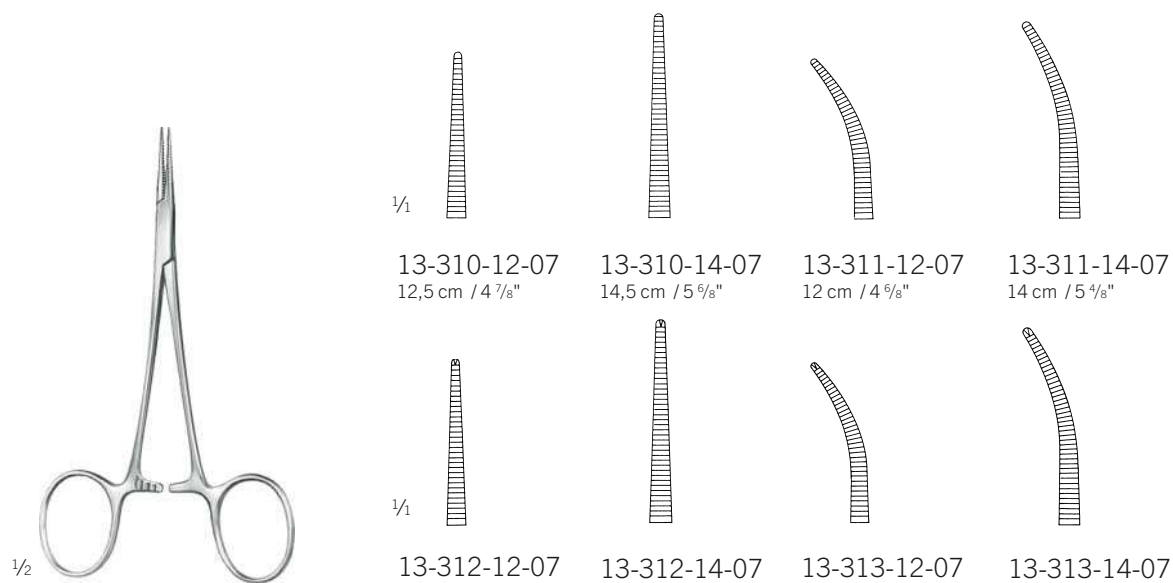

Halsted-Mosquito
13-310-12-07 -
13-313-14-07

13-310-12-07
12,5 cm / 4 7/8"

13-310-14-07
14,5 cm / 5 5/8"

13-311-12-07
12 cm / 4 5/8"

13-311-14-07
14 cm / 5 1/2"

13-312-12-07
12,5 cm / 4 7/8"

13-312-14-07
14,5 cm / 5 5/8"

13-313-12-07
12,5 cm / 4 7/8"

13-313-14-07
14,5 cm / 5 5/8"



Arterienklemmen

Haemostatic Forceps
Pinzas hemostáticas
Pincas hémostatiques
Pinze emostatiche

Ti



1/2

Halsted-Mosquito
13-310-62-09 -
13-313-62-09

1/1				
	13-310-62-09 12,5 cm / 4 7/8"	13-311-62-09 12 cm / 4 6/8"	13-312-62-09 12 cm / 4 6/8"	13-313-62-09 12 cm / 4 6/8"
			1:2	1:2



1/2

Halsted-Mosquito
13-316-18-07 -
13-319-21-07

1/1				
	13-316-18-07 18,5 cm / 7 2/8"	13-316-21-07 21 cm / 8 2/8"	13-317-18-07 18 cm / 7 1/8"	13-317-21-07 20,5 cm / 8 1/8"
1/1				
	13-318-18-07 18,5 cm / 7 2/8"	13-318-21-07 21 cm / 8 2/8"	13-319-18-07 18 cm / 7 1/8"	13-319-21-07 20,5 cm / 8 1/8"
	1:2	1:2	1:2	1:2

Arterienklemmen

Haemostatic Forceps
Pinzas hemostáticas
Pincas hémostatiques
Pinze emostatiche

Arterienklemmen

Haemostatic Forceps
Pinzas hemostáticas
Pincas hémostatiques
Pinze emostatiche

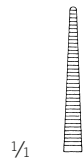

1/1

13-320-10-07
10 cm / 3 7/8"



13-320-12-07
12 cm / 4 6/8"



13-321-10-07
10 cm / 3 7/8"



13-321-12-07
12 cm / 4 6/8"



1/2

Mikro-Mosquito
13-320-10-07 -
13-323-12-07

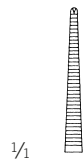

1/1

13-322-10-07
10 cm / 3 7/8"



13-322-12-07
12 cm / 4 6/8"



13-323-10-07
10 cm / 3 7/8"



13-323-12-07
12 cm / 4 6/8"



13



1/2

Providence-Hospital
13-324-14-07 -
13-325-14-07

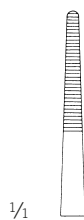

1/1

13-324-14-07
14 cm / 5 4/8"

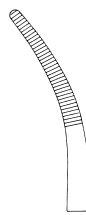

13-325-14-07
13,5 cm / 5 3/8"



1/2

Leriche
13-326-15-07 -
13-329-15-07

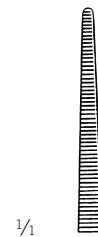

1/1

13-326-15-07
15,5 cm / 6 1/8"

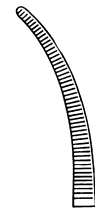

13-327-15-07
15 cm / 5 7/8"



13-328-15-07
15,5 cm / 6 1/8"

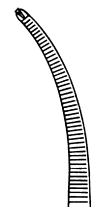

13-329-15-07
15 cm / 5 7/8"



Arterienklemmen

Haemostatic Forceps
Pinzas hemostáticas
Pinces hémostatiques
Pinze emostatiche



1/1

13-330-14-07
14,5 cm / 5 7/8"

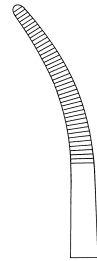

13-331-14-07
14 cm / 5 4/8"

Kelly
13-330-14-07 -
13-331-14-07



1/1

Dunhill
13-332-12-07
12,5 cm / 4 7/8"



1/1

Dunhill
13-333-19-07
18,5 cm / 7 2/8"

Arterienklemmen, Präparierklemmen

Haemostatic Forceps, Dissecting and Ligature Forceps
 Pinzas hemostáticas, Pinzas para preparación y ligadura
 Pincas hémostatiques, Pincas à dissecquer et à ligatures
 Pinze emostatiche, Pinze per preparazioni e legature

Arterienklemmen

Haemostatic Forceps
 Pinzas hemostáticas
 Pincas hémostatiques
 Pinze emostatiche



Kelly-Rankin
 13-334-16-07 -
 13-335-16-07
 16 cm / 6 2/8"

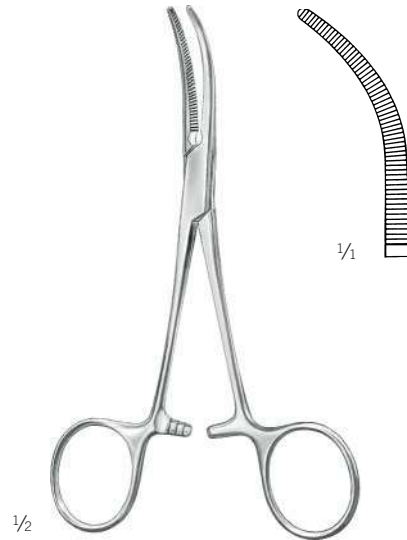

Overholt-Baby
 13-339-14-07
 13,5 cm / 5 3/8"

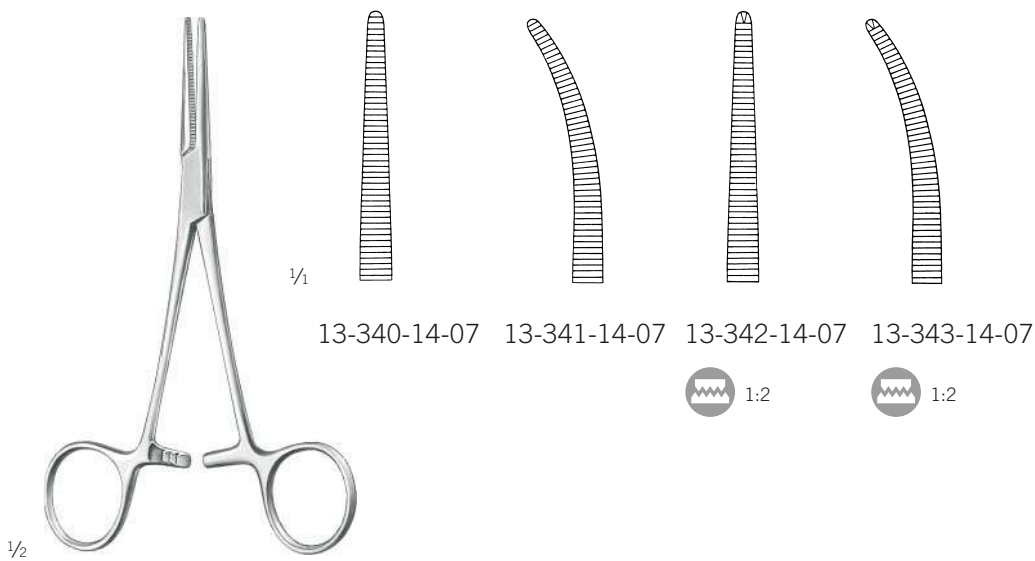

Crile
 13-340-14-07 -
 13-343-14-07
 14,5 cm / 5 7/8"

Arterienklemmen

Haemostatic Forceps
Pinzas hemostáticas
Pincès hémostatiques
Pinze emostatiche

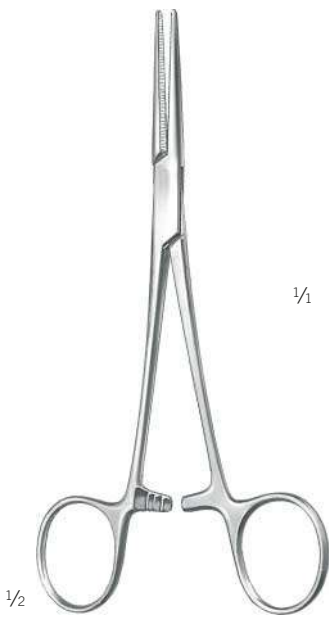

1/2

13-346-16-07

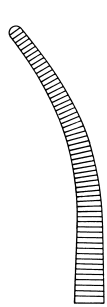

13-347-16-07

Crile-Rankin
13-346-16-07 -
13-347-16-07
16 cm / 6 2/8"



1/2

1/2

13-348-15-07

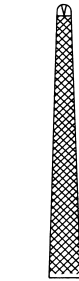

13-350-15-07



1:2

Lovelace
13-348-15-07 -
13-350-15-07
16 cm / 6 2/8"

kreuzgerieftes Maul
cross serrated jaw
boca estriada en forma de cruz
mors à rainures croisées
morso con striatura cruciforme



1/2

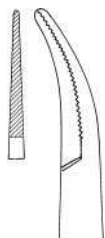

1/2

Dandy-Mosquito
13-351-12-07
12 cm / 4 6/8"

seitlich gebogen
laterally curved
curva lateralmente
courbe lateralement
curva laterale



1/2

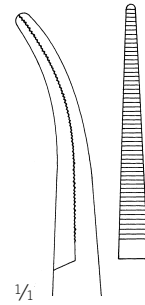

1/2

13-355-14-07
14,5 cm / 5 6/8"

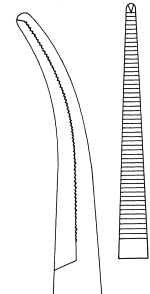

13-357-14-07
14 cm / 5 4/8"



1:2

Dandy
13-355-14-07 -
13-357-14-07

seitlich gebogen
laterally curved
curva lateralmente
courbe lateralement
curva laterale

Arterienklemmen, Präparierklemmen

Haemostatic Forceps, Dissecting and Ligature Forceps
 Pinzas hemostáticas, Pinzas para preparación y ligadura
 Pincas hémostatiques, Pincas à dissecquer et à ligatures
 Pinze emostatiche, Pinze per preparazioni e legature

Arterienklemmen

Haemostatic Forceps
 Pinzas hemostáticas
 Pincas hémostatiques
 Pinze emostatiche

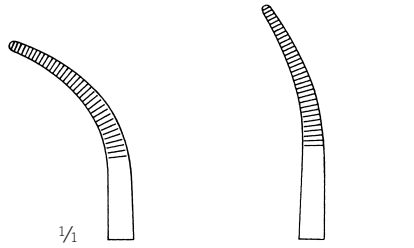

13-363-18-07 13-363-19-07
 18,5 cm / 7 3/8" 19 cm / 7 4/8"

Schnidt
 13-363-18-07 -
 13-363-19-07

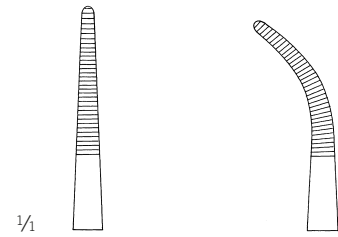

13-364-18-07 13-365-18-07
 19 cm / 7 4/8" 18,5 cm / 7 2/8"

Adson
 13-364-18-07 -
 13-365-18-07

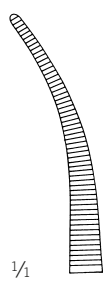

Martin-Fuchsig
 13-369-20-07
 20,5 cm / 8 1/8"

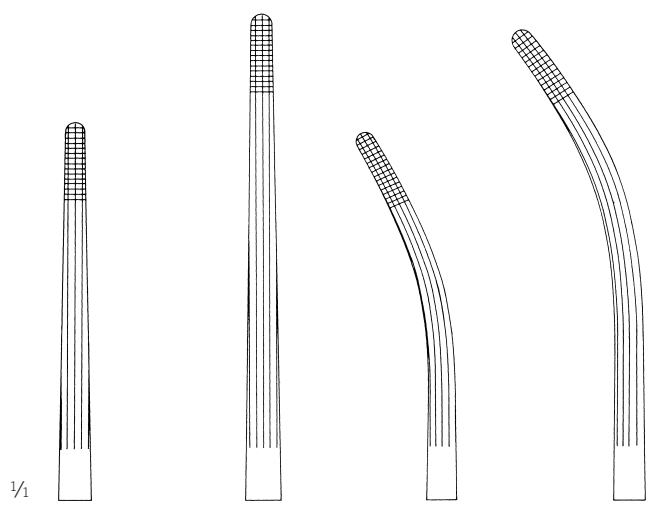

13-370-16-07 13-370-20-07 13-371-16-07 13-371-20-07
 17 cm / 6 6/8" 20,5 cm / 8 1/8" 16,5 cm / 6 4/8" 20 cm / 7 7/8"

Rochester-Carmalt
 13-370-16-07 -
 13-371-20-07

13

Arterienklemmen

Haemostatic Forceps
Pinzas hemostáticas
Pincès hémostatiques
Pinze emostatiche



1/4

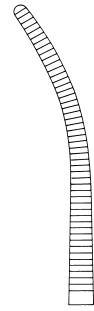

13-374-13-07

13,5 cm / 5 3/8"

13-374-14-07

14,5 cm / 5 7/8"

13-374-16-07

17 cm / 6 5/8"

13-375-13-07

13 cm / 5 1/8"

13-375-14-07

14 cm / 5 4/8"

13-375-16-07

16,5 cm / 6 4/8"

1/2

Pean

13-374-13-07 -

13-375-16-07



1/4

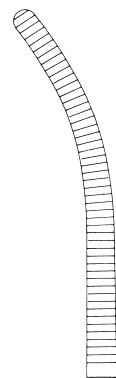
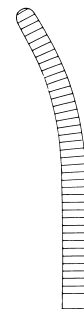
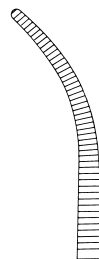
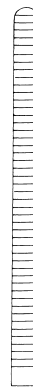
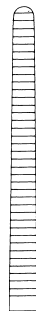

13-380-14-07

14,5 cm / 5 6/8"

13-380-16-07

16,5 cm / 6 4/8"

13-380-18-07

18,5 cm / 7 2/8"

13-381-14-07

14 cm / 5 4/8"

13-381-16-07

16 cm / 6 2/8"

13-381-18-07

18 cm / 7 1/8"

1/2

Pean-Nippon

13-380-14-07 -

13-381-18-07

Arterienklemmen

Haemostatic Forceps
Pinzas hemostáticas
Pincès hémostatiques
Pinze emostatiche

Arterienklemmen

Haemostatic Forceps
Pinzas hemostáticas
Pincès hémostatiques
Pinze emostatiche



13

1/2

1/4

13-382-14-07	13-382-16-07	13-382-18-07	13-383-14-07	13-383-16-07	13-383-18-07
14,5 cm / 5 7/8"	16,5 cm / 6 4/8"	18,5 cm / 7 2/8"	14 cm / 5 4/8"	16 cm / 6 2/8"	18 cm / 7 1/8"
1:2	1:2	1:2	1:2	1:2	1:2

Kocher-Nippon
13-382-14-07 -
13-383-18-07

1/2

1/4

13-384-13-07	13-384-14-07	13-384-16-07	13-385-13-07	13-385-14-07	13-385-16-07
13 cm / 5 1/8"	14 cm / 5 4/8"	16 cm / 6 2/8"	13 cm / 5 1/8"	14 cm / 5 4/8"	16 cm / 6 2/8"
1:2	1:2	1:2	1:2	1:2	1:2

Kocher
13-384-13-07 -
13-385-16-07

Arterienklemmen

Haemostatic Forceps
Pinzas hemostáticas
Pincas hémostatiques
Pinze emostatiche

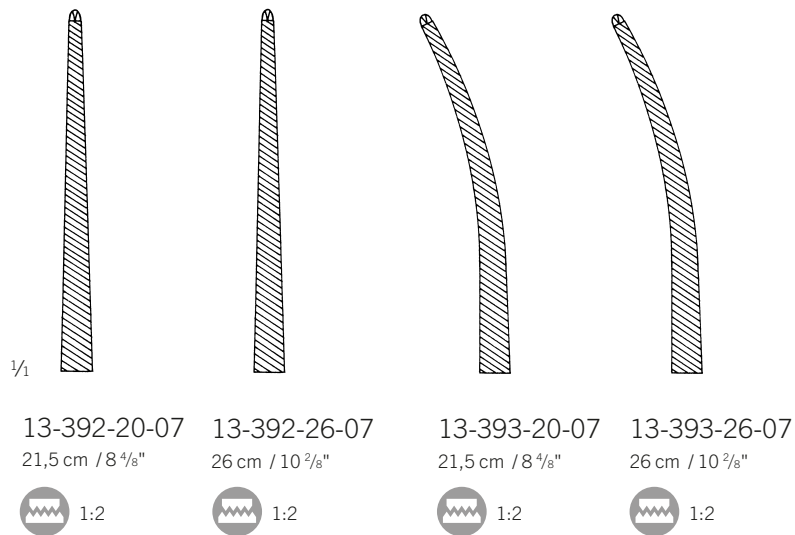
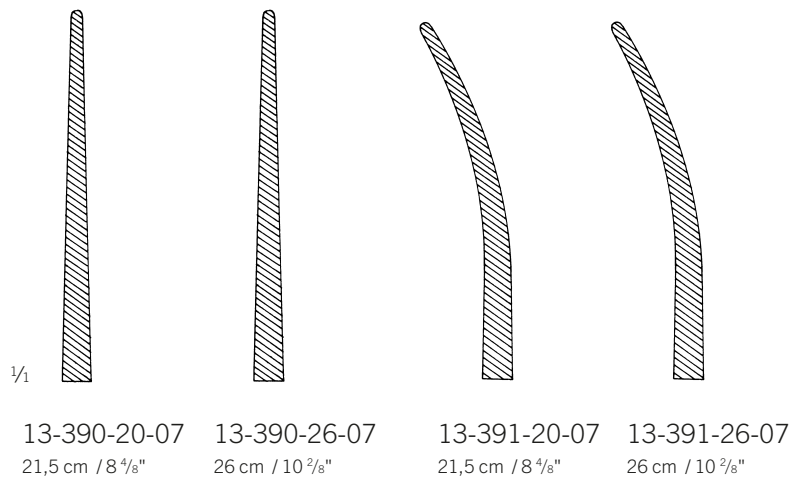

Bengolea
13-390-20-07 -
13-393-26-07

Arterienklemmen

Haemostatic Forceps
Pinzas hemostáticas
Pincas hémostatiques
Pinze emostatiche

Arterienklemmen

Haemostatic Forceps
Pinzas hemostáticas
Pincas hémostatiques
Pinze emostatiche

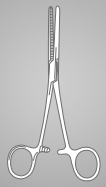

13

1/1



13-410-14-07
14,5 cm / 5 7/8"



13-410-16-07
16,5 cm / 6 4/8"

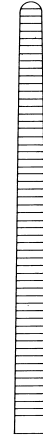

13-410-18-07
18,5 cm / 7 3/8"



13-410-20-07
20,5 cm / 8 1/8"

1/2



Pean (Rochester)
13-410-14-07 -
13-410-30-07

1/1

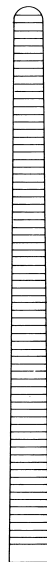

13-410-22-07
22,5 cm / 8 7/8"



13-410-24-07
24 cm / 9 4/8"

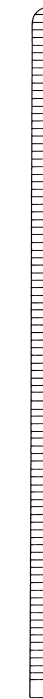

13-410-26-07
26 cm / 10 2/8"

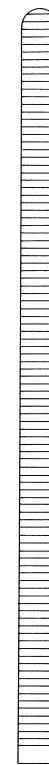

13-410-30-07
31 cm / 12 2/8"

Arterienklemmen

Haemostatic Forceps

Pinzas hemostáticas

Pinces hémostatiques

Pinze emostatiche

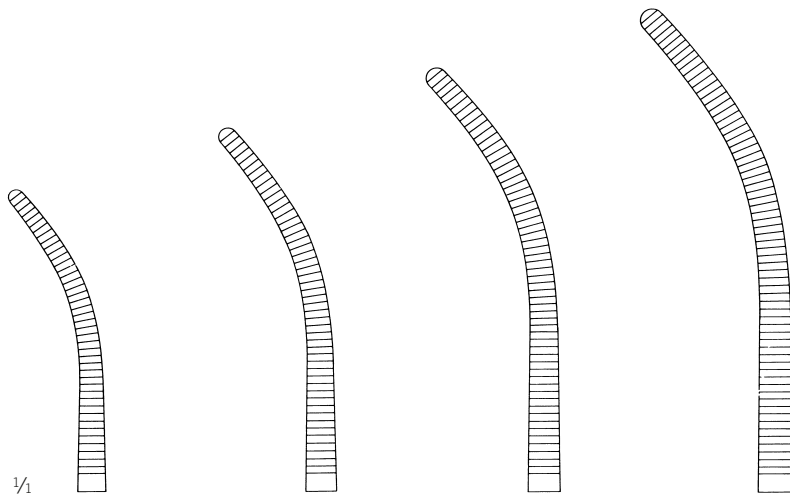

1/1

13-411-14-07
14 cm / 5 4/8"

13-411-16-07
16,5 cm / 6 4/8"

13-411-18-07
18,5 cm / 7 2/8"

13-411-20-07
20,5 cm / 8 1/8"



1/2

Pean (Rochester)
13-411-14-07 -
13-411-30-07

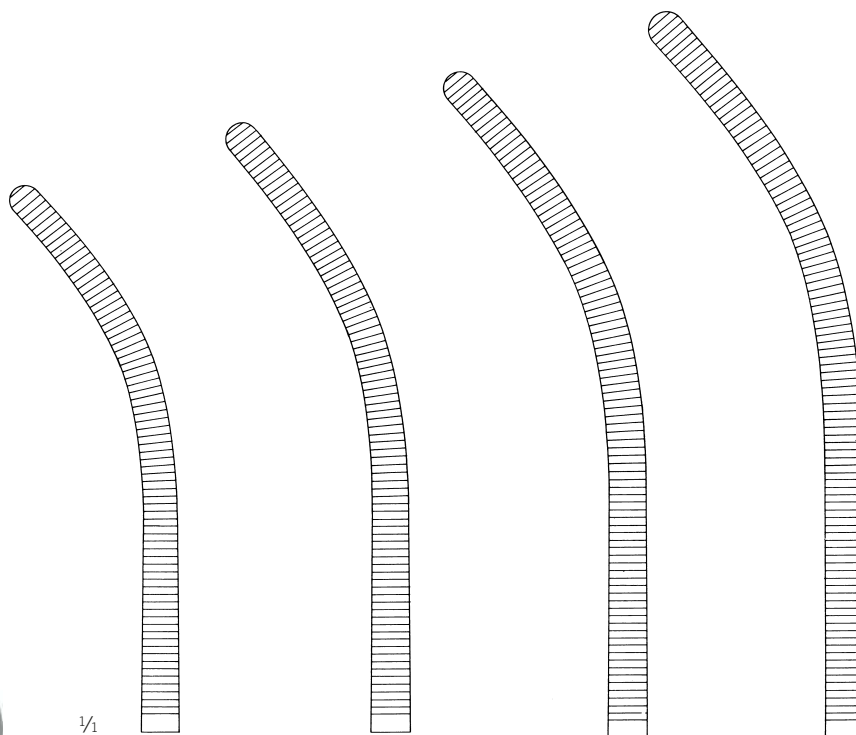

1/1

13-411-22-07
22 cm / 8 5/8"

13-411-24-07
24 cm / 9 4/8"

13-411-26-07
26 cm / 10 2/8"

13-411-30-07
30,5 cm / 12"

Arterienklemmen

Haemostatic Forceps
Pinzas hemostáticas
Pincas hémostatiques
Pinze emostatiche

Arterienklemmen

Haemostatic Forceps
Pinzas hemostáticas
Pincas hémostatiques
Pinze emostatiche

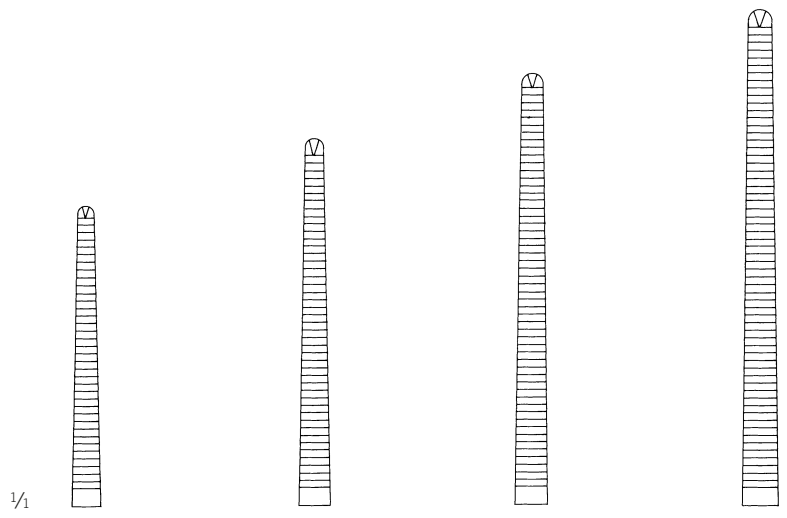

13-414-14-07 14,5 cm / 5 6/8"	13-414-16-07 16,5 cm / 6 4/8"	13-414-18-07 18,5 cm / 7 2/8"	13-414-20-07 20,5 cm / 8 1/8"
1:2	1:2	1:2	1:2



1/2
Kocher (Ochsner)
13-414-14-07 -
13-414-30-07

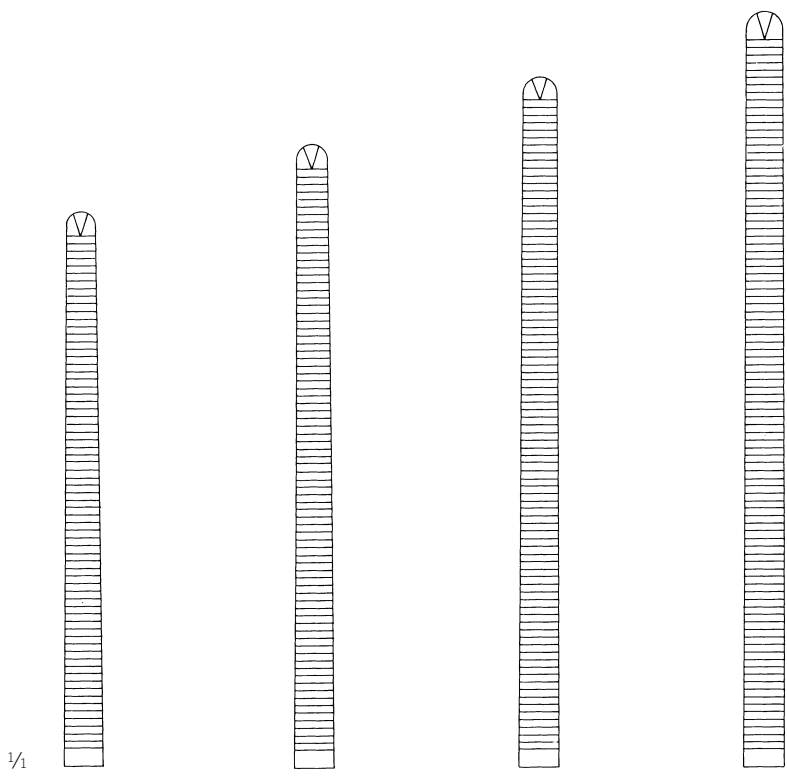

13-414-22-07 22,5 cm / 8 7/8"	13-414-24-07 24 cm / 9 4/8"	13-414-26-07 26 cm / 10 2/8"	13-414-30-07 31 cm / 12 2/8"
1:2	1:2	1:2	1:2

Arterienklemmen

Haemostatic Forceps
Pinzas hemostáticas
Pincas hémostatiques
Pinze emostatiche

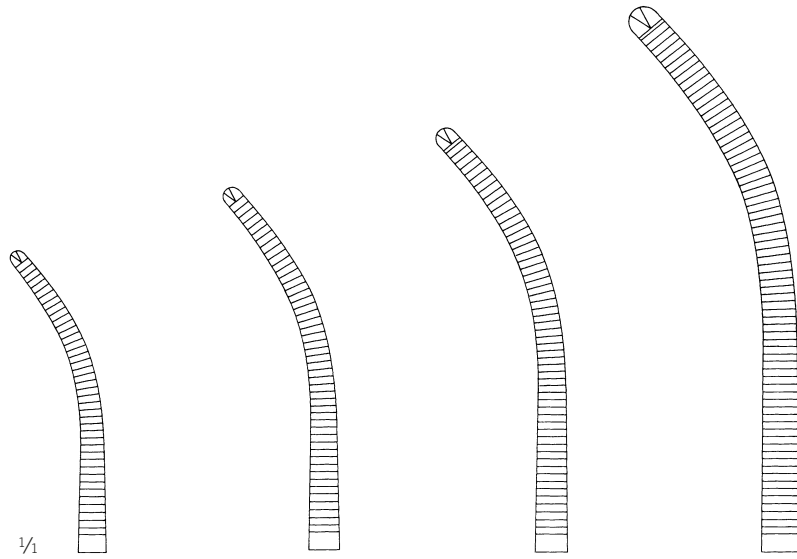

1/4

13-415-14-07

14 cm / 5 4/8"



13-415-16-07

16,5 cm / 6 4/8"



13-415-18-07

18,5 cm / 7 2/8"



13-415-20-07

20 cm / 7 7/8"



1/2

Kocher (Ochsner)
13-415-14-07 -
13-415-30-07

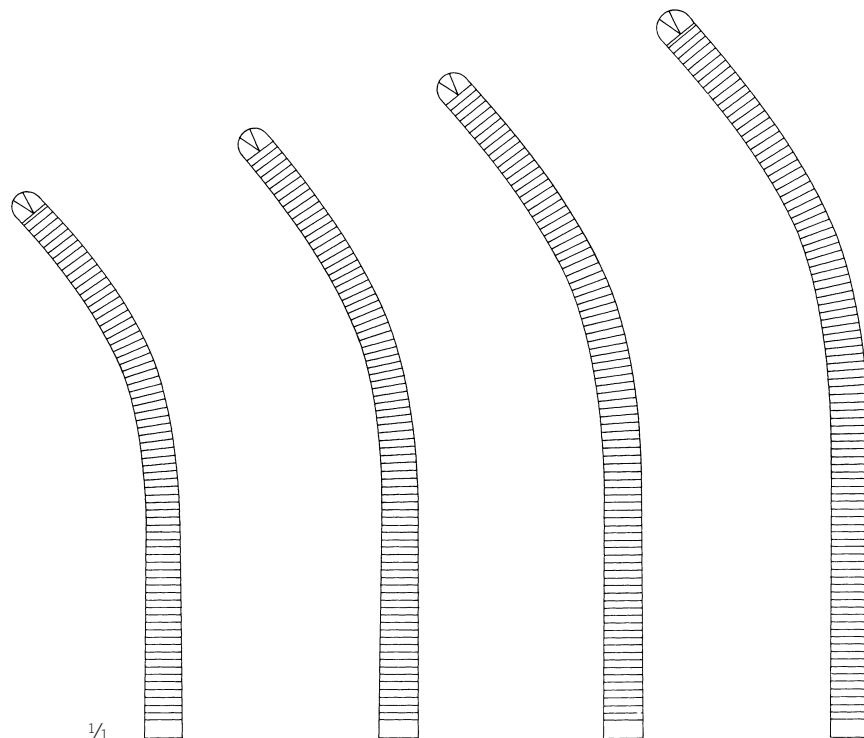

1/4

13-415-22-07

22,5 cm / 8 7/8"



13-415-24-07

24 cm / 9 4/8"



13-415-26-07

26 cm / 10 2/8"



13-415-30-07

30,5 cm / 12"



Präparierklemmen

Dissecting and Ligature Forceps
Pinzas para preparación y ligadura
Pinces à disséquer et à ligatures
Pinze per preparazioni e legature

Arterienklemmen

Haemostatic Forceps
Pinzas hemostáticas
Pinces hémostatiques
Pinze emostatiche

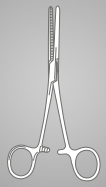

1/1

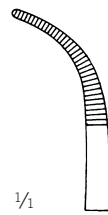

Fig. 1
13-417-01-07
18,5 cm / 7 3/8"

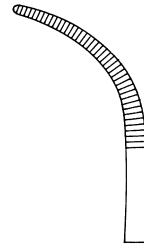

Fig. 2
13-417-02-07
20,5 cm / 8 1/8"

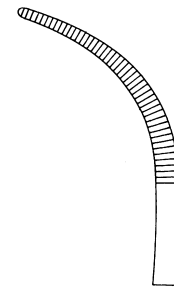

Fig. 3
13-417-03-07
21cm / 8 2/8"

1/1

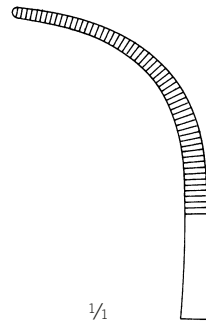

Fig. 4
13-417-04-07
21,5 cm / 8 2/8"

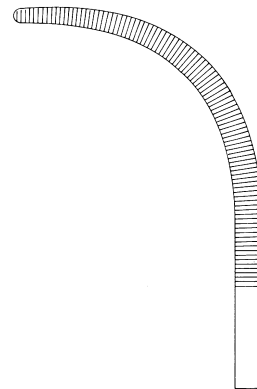

Fig. 5
13-417-05-07
24,5 cm / 9 6/8"

1/2



Overholt-Martin
13-417-01-07 -
13-417-05-07

Präparierklemmen

Dissecting and Ligature Forceps
 Pinzas para preparación y ligadura
 Pincès à disséquer et à ligatures
 Pinze per preparazioni e legature

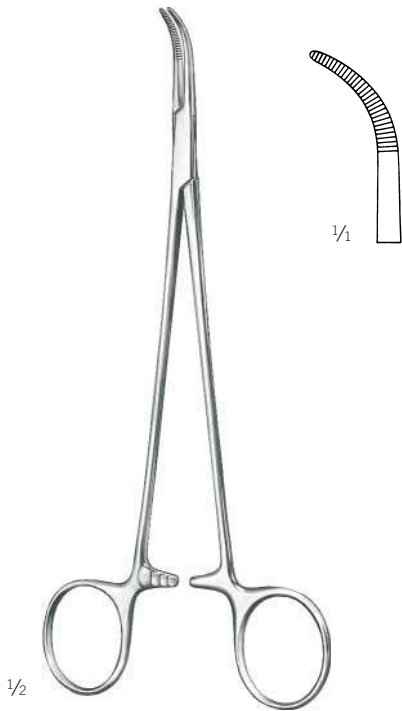

Mixer-Baby
 13-419-18-07
 18,5 cm / 7 3/8"



Adson-Baby
 13-421-14-07 -
 13-421-18-07

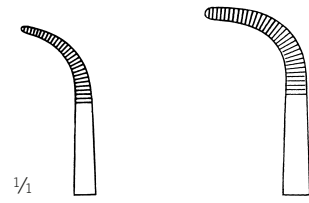

13-421-14-07
 14,5 cm / 5 5/8"

13-421-18-07
 18 cm / 7 1/8"



Heiss
 13-422-20-07 -
 13-425-20-07

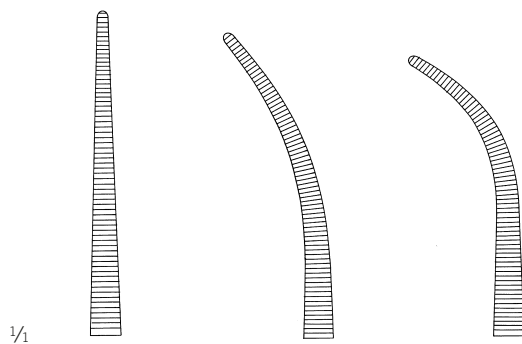

13-422-20-07
 21 cm / 8 2/8"

13-423-20-07
 20,5 cm / 8 1/8"

13-425-20-07
 21 cm / 8 2/8"

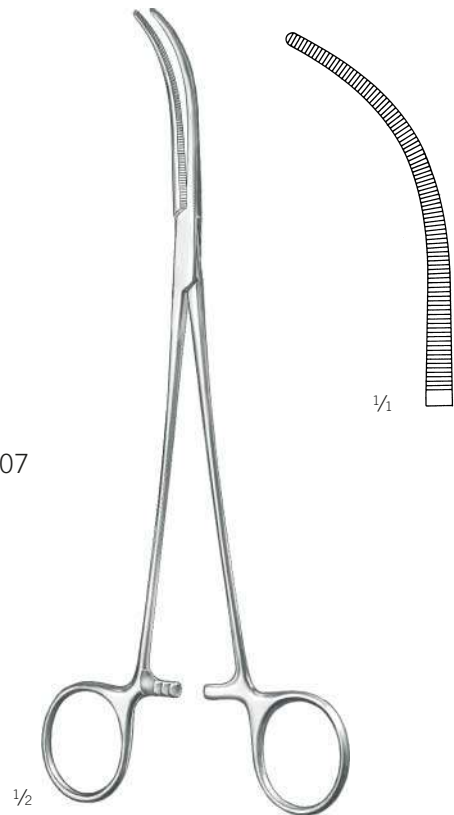

Overholt-Mixer
 13-427-21-07
 22 cm / 8 5/8"

Präparierklemmen

Dissecting and Ligature Forceps
Pinzas para preparación y ligadura
Pincès à disséquer et à ligatures
Pinze per preparazioni e legature

Arterienklemmen

Haemostatic Forceps
Pinzas hemostáticas
Pincès hémostatiques
Pinze emostatiche



1/2

Roberts
13-428-22-07 -
13-429-22-07

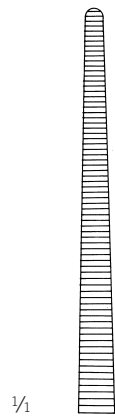

1/1

13-428-22-07
22,5 cm / 8 7/8"

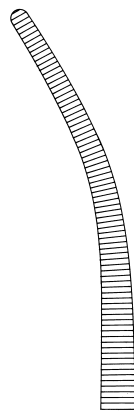

13-429-22-07
22 cm / 8 5/8"



1/2

Sarot
13-432-24-07 -
13-433-24-07

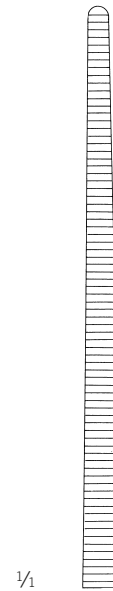

1/1

13-432-24-07
25 cm / 9 7/8"

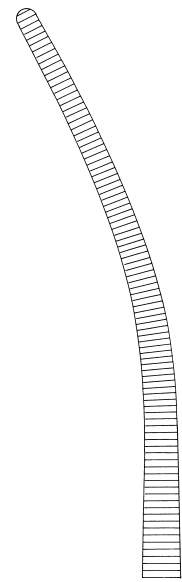

13-433-24-07
24,5 cm / 9 5/8"

Präparierklemmen

Dissecting and Ligature Forceps
Pinzas para preparación y ligadura
Pincas à disséquer et à ligatures
Pinze per preparazioni e legature



1/1

13-439-18-07
18,5 cm / 7 2/8"

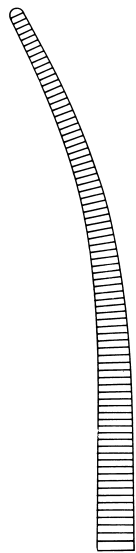

13-439-24-07
24,5 cm / 9 5/8"

1/2

Crafoord
13-439-18-07 -
13-439-24-07

Präparierklemmen

Dissecting and Ligature Forceps
 Pinzas para preparación y ligadura
 Pincès à disséquer et à ligatures
 Pinze per preparazioni e legature

Arterienklemmen

Haemostatic Forceps
 Pinzas hemostáticas
 Pincès hémostatiques
 Pinze emostatiche

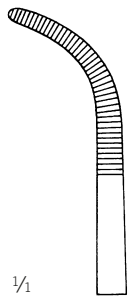

Fig. 1
 13-443-01-07
 20,5 cm / 8 1/8"

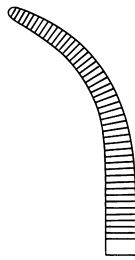

Fig. 2
 13-443-02-07
 20 cm / 7 7/8"

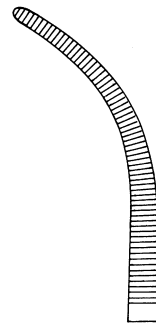

Fig. 3
 13-443-03-07
 21,5 cm / 8 4/8"

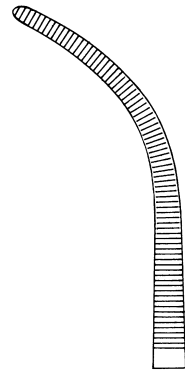

Fig. 4
 13-443-04-07
 22 cm / 8 5/8"

13-447-01-07
 27 cm / 10 5/8"

13-447-02-07
 26,5 cm / 10 3/8"

13-447-03-07
 27,5 cm / 10 7/8"

13-447-04-07
 28 cm / 11"



1/2

Overholt-Geissendörfer
 13-443-01-07 -
 13-447-07-07

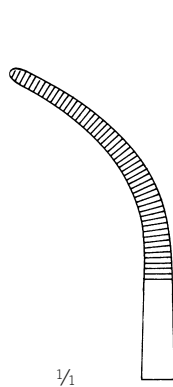

Fig. 5
 13-443-05-07
 21,5 cm / 8 4/8"

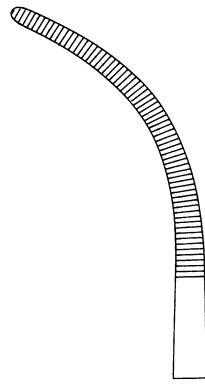

Fig. 6
 13-443-06-07
 21,5 cm / 8 5/8"

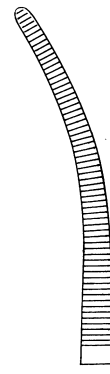

Fig. 7
 13-443-07-07
 22 cm / 8 5/8"

13-447-05-07
 27,5 cm / 10 7/8"

13-447-06-07
 28 cm / 11"

13-447-07-07
 27,5 cm / 10 7/8"

Präparierklemmen

Dissecting and Ligature Forceps

Pinzas para preparación y ligadura

Pinces à disséquer et à ligatures

Pinze per preparazioni e legature

finoLine



1/2

Overholt-Fino
13-448-00-07 -
13-448-06-07

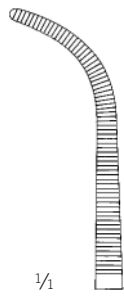

1/1

13-448-00-07
21,5 cm / 8 4/8"

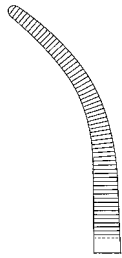

13-448-01-07
22 cm / 8 5/8"

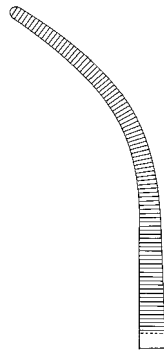

13-448-02-07
22,5 cm / 8 7/8"

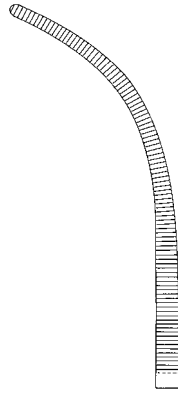

13-448-03-07
23 cm / 9"

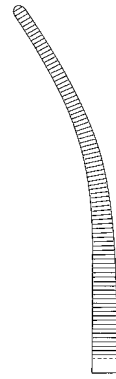

13-448-06-07
22,5 cm / 8 7/8"

Präparierklemmen

Dissecting and Ligature Forceps
Pinzas para preparación y ligadura
Pinces à disséquer et à ligatures
Pinze per preparazioni e legature

Arterienklemmen

Haemostatic Forceps
Pinzas hemostáticas
Pinces hémostatiques
Pinze emostatiche



13

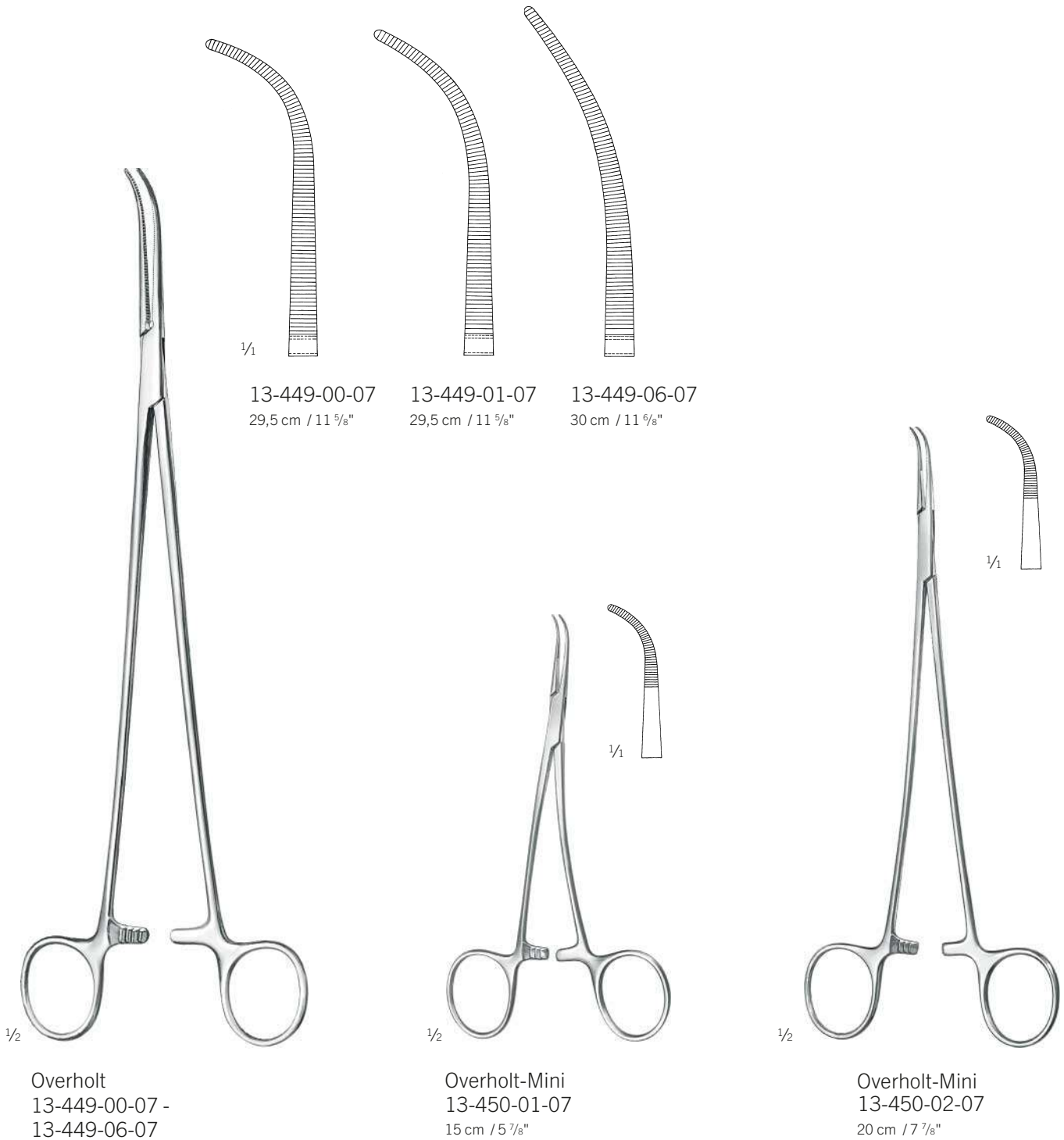

Präparierklemmen

Dissecting and Ligature Forceps
 Pinzas para preparación y ligadura
 Pinces à disséquer et à ligatures
 Pinze per preparazioni e legature



1/2

Gemini
 13-451-13-07 -
 13-451-28-07

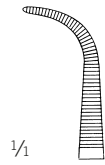

1/4

13-451-13-07
 13 cm / 5 1/8"

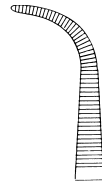

13-451-16-07
 16 cm / 6 2/8"



13-451-18-07
 18 cm / 7 1/8"

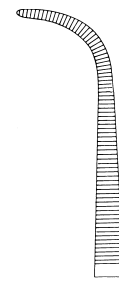

13-451-20-07
 21 cm / 8 2/8"

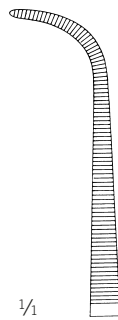

1/4

13-451-23-07
 23 cm / 9"

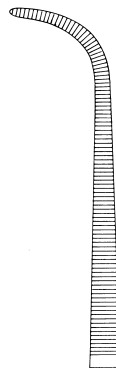

13-451-25-07
 25 cm / 9 7/8"

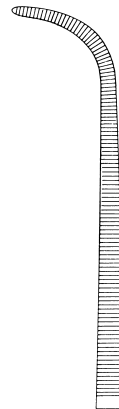

13-451-28-07
 28 cm / 11"



1/2

Mini-Gemini
 13-453-18-07 -
 13-453-28-07

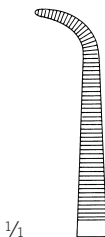

1/4

13-453-18-07
 18 cm / 7 1/8"

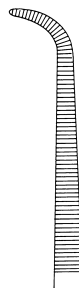

13-453-22-07
 23 cm / 9"



13-453-25-07
 25 cm / 9 7/8"



13-453-28-07
 28,5 cm / 11 2/8"

Präparierklemmen

Dissecting and Ligature Forceps
Pinzas para preparación y ligadura
Pinces à disséquer et à ligatures
Pinze per preparazioni e legature

Arterienklemmen

Haemostatic Forceps
Pinzas hemostáticas
Pinces hémostatiques
Pinze emostatiche

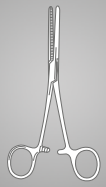

Fig. 1 13-461-01-07 24 cm / 9 4/8"	Fig. 2 13-461-02-07 24 cm / 9 4/8"	Fig. 3 13-461-03-07 23,5 cm / 9 2/8"	Fig. 4 13-461-04-07 24 cm / 9 4/8"	Fig. 5 13-461-05-07 24 cm / 9 4/8"
---	---	---	---	---

Rumel
13-461-01-07 -
13-461-05-07

Präparierklemmen

Dissecting and Ligature Forceps

Pinzas para preparación y ligadura

Pinces à disséquer et à ligatures

Pinze per preparazioni e legature



$\frac{1}{2}$

Zenker
13-469-01-07 -
13-469-02-07

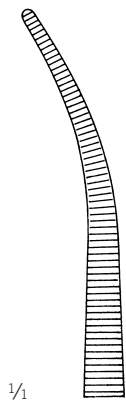

$\frac{1}{4}$

13-469-01-07
29,5 cm / 11 $\frac{5}{8}$ "

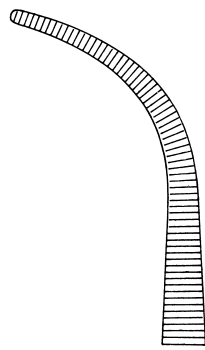

13-469-02-07
28,5 cm / 11 $\frac{2}{8}$ "



$\frac{1}{2}$

Mixer-Baby
13-471-14-07
13 cm / 5 $\frac{1}{8}$ "



$\frac{1}{4}$

Präparierklemmen

Dissecting and Ligature Forceps
 Pinzas para preparación y ligadura
 Pincès à disséquer et à ligatures
 Pinze per preparazioni e legature

Arterienklemmen

Haemostatic Forceps
 Pinzas hemostáticas
 Pincès hémostatiques
 Pinze emostatiche

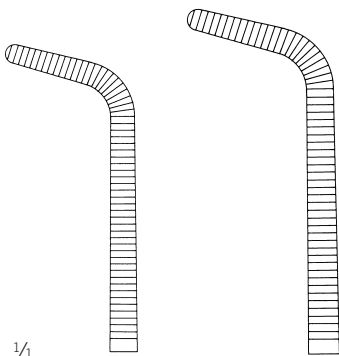
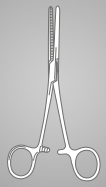

1/4

13-473-15-07
 16 cm / 6 2/8"

13-473-19-07
 17,5 cm / 6 7/8"

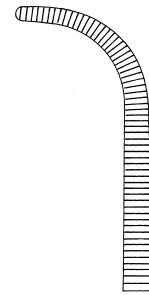

13-479-14-07
 15 cm / 5 7/8"

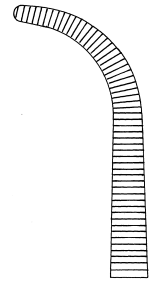

13-479-17-07
 18 cm / 7 1/8"



1/2

Mixer
 13-473-15-07 -
 13-473-19-07



1/2

O'Shaughnessy
 13-479-14-07 -
 13-479-26-07

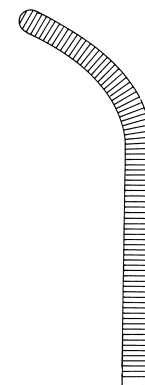

13-479-19-07
 18,5 cm / 7 2/8"

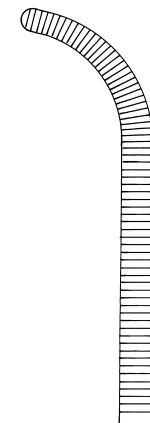

13-479-20-07
 20 cm / 7 7/8"

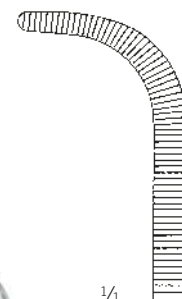

1/4

13-479-23-07
 23 cm / 9"

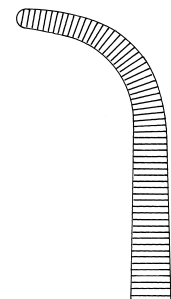

13-479-26-07
 26 cm / 10 2/8"

Präparierklemmen

Dissecting and Ligature Forceps
Pinzas para preparación y ligadura
Pinces à disséquer et à ligatures
Pinze per preparazioni e legature

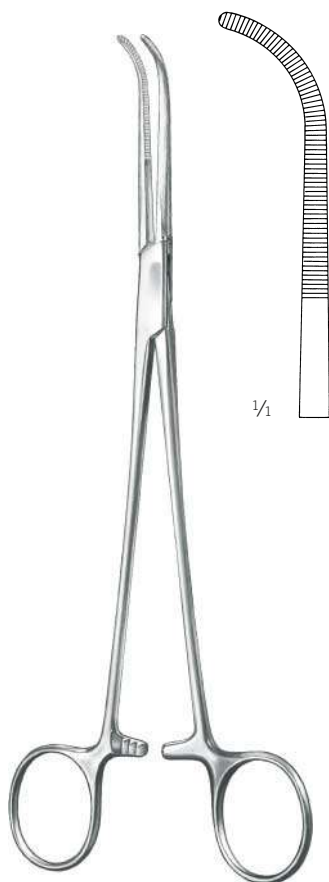

Mixer
13-483-22-07
22,5 cm / 8 7/8"

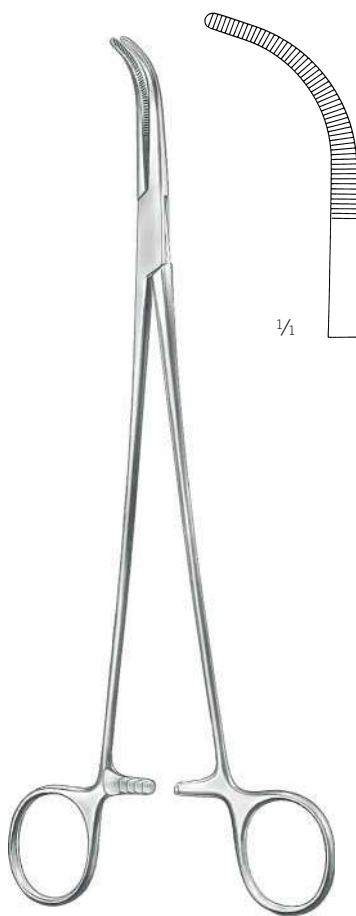

Mixer
13-485-23-07
23 cm / 9"



13-487-21-07
21 cm / 8 2/8"

13-487-24-07
24,5 cm / 9 5/8"

Präparierklemmen

Dissecting and Ligature Forceps
Pinzas para preparación y ligadura
Pincès à disséquer et à ligatures
Pinze per preparazioni e legature

Arterienklemmen

Haemostatic Forceps
Pinzas hemostáticas
Pincès hémostatiques
Pinze emostatiche



1/2

Mixer
13-491-22-07 -
13-495-28-07

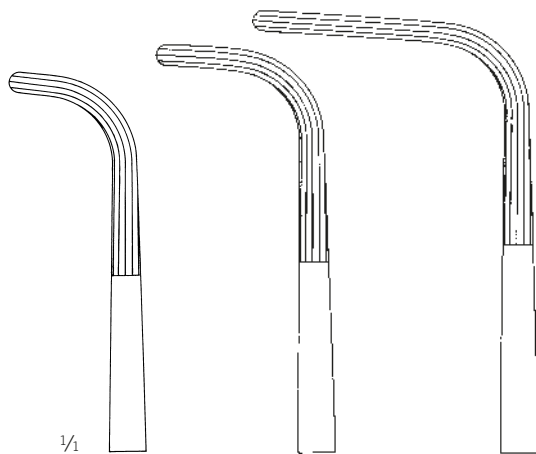

1/4

13-491-22-07
22,5 cm / 8 7/8"

13-493-25-07
26 cm / 10 2/8"

13-495-28-07
28 cm / 11"

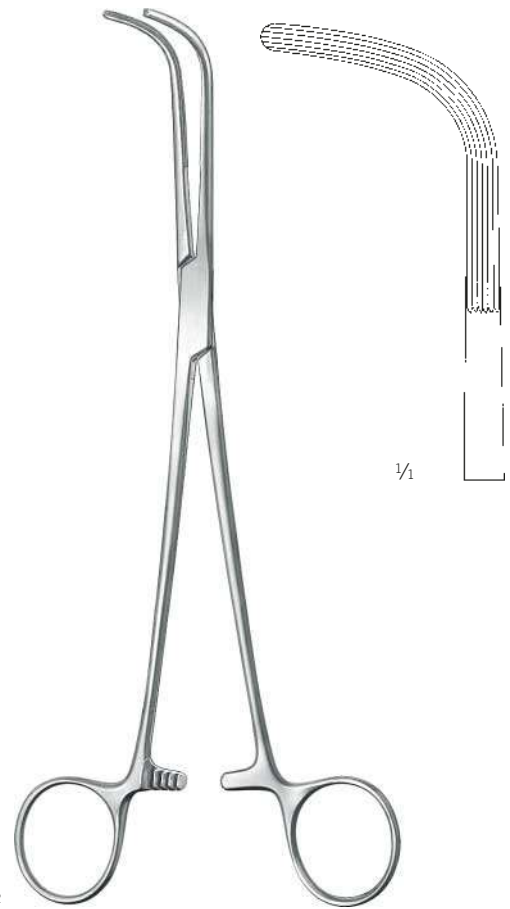

1/2

McQuigg-Mixer
13-497-22-07
23,5 cm / 9 2/8"

Gallenkanalklemmen, Präparierklemmen

Bile Duct Clamps, Dissecting and Ligature Forceps

Pinzas para conducto biliar, Pinzas para preparación y ligadura

Pinces pour les voies biliaires, Pincés à disséquer et à ligatures

Pinze per vie biliari, Pinze per preparazioni e legature

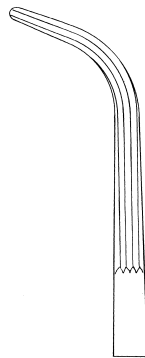

13-511-19-07
19,5 cm / 7 ⁵/₈"

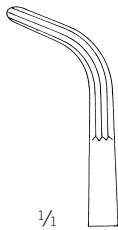

$\frac{1}{2}$

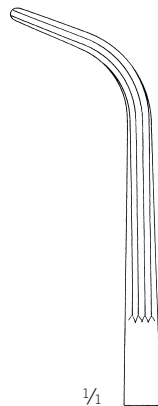

$\frac{1}{2}$

13-513-23-07
22,5 cm / 8 ⁷/₈"

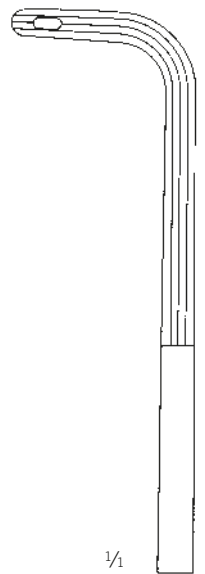

$\frac{1}{2}$



$\frac{1}{2}$

Lower
13-501-18-07
18,5 cm / 7 ¹/₄"



$\frac{1}{2}$

Lahey
13-511-19-07 -
13-513-23-07



$\frac{1}{2}$

Finochietto
13-521-24-07
24,5 cm / 9 ⁵/₈"

Tangentialklemmen, Nierenstielklemmen

Tangential Forceps, Kidney Pedicle Clamps

Pinzas tangenciales, Pinzas para pedículo renal

Pinces tangentielles, Pince-clamps pour pédicules rénaux

Pinze tangenziali, Pinze per peduncoli renali

Arterienklemmen

Haemostatic Forceps

Pinzas hemostáticas

Pinces hémostatiques

Pinze emostatiche



Atrauma

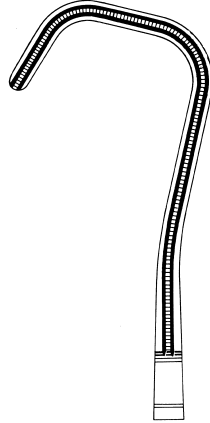
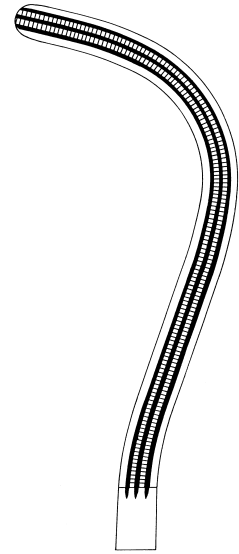

Fig. 1
13-527-01-07
25 cm / 9 7/8"



13-529-23-07
23 cm / 9"

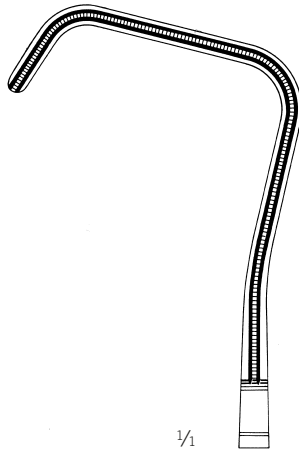
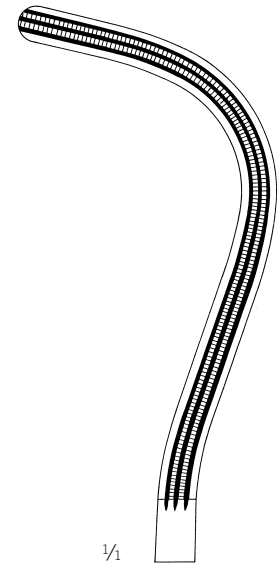

Fig. 2
13-527-02-07
26 cm / 10 2/8"



13-529-24-07
24 cm / 9 4/8"



1/2

Uro-Tangential
13-527-01-07 -
13-527-02-07



1/2

Guyon
13-529-23-07 -
13-529-24-07

Nierenstielklemmen

Kidney Pedicle Clamps

Pinzas para pedículo renal

Pince-clamps pour pédicules rénaux

Pinze per peduncoli renali



Guyon
13-531-20-07 -
13-531-24-07

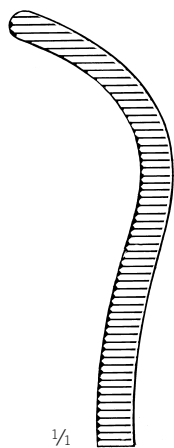

13-531-20-07
19,5 cm / 7 5/8"

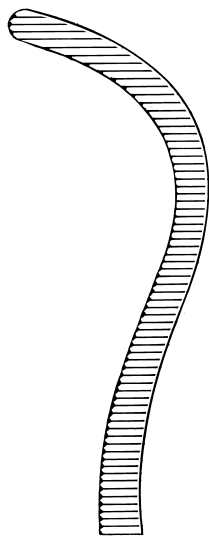

13-531-22-07
21,5 cm / 8 4/8"

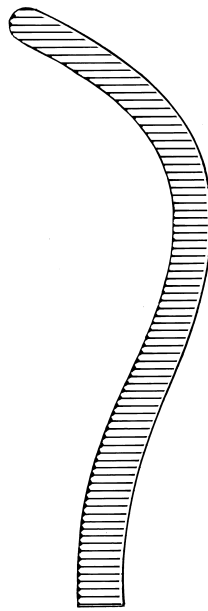

13-531-24-07
24,5 cm / 9 5/8"

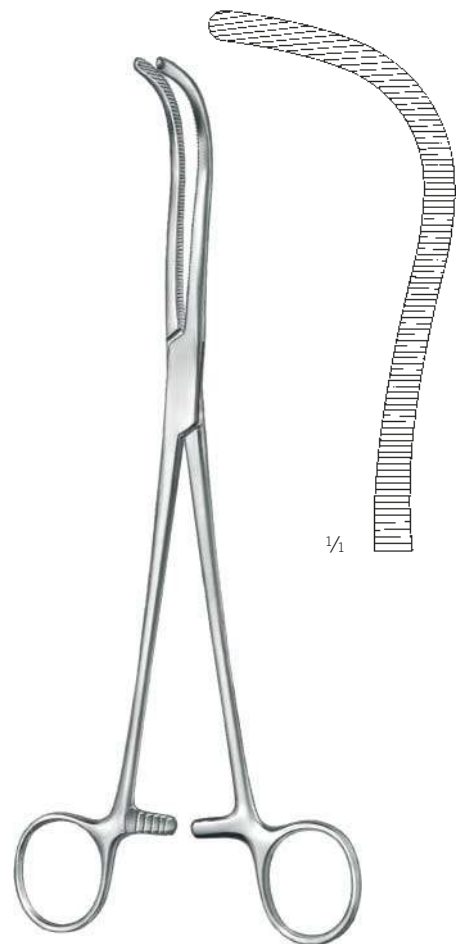

Guyon
13-533-23-07
24 cm / 9 4/8"

Gallenkanalklemmen

Bile Duct Clamps
Pinzas para conducto biliar
Pincas pour les voies biliaires
Pinze per vie biliari

Arterienklemmen

Haemostatic Forceps
Pinzas hemostáticas
Pincas hémostatiques
Pinze emostatiche

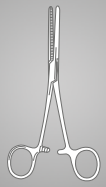

Desjardins
13-571-21-07
21 cm / 8 2/8"

Präparierklemmen

Dissecting and Ligature Forceps
Pinzas para preparación y ligadura
Pincas à disséquer et à ligatures
Pinze per preparazioni e legature

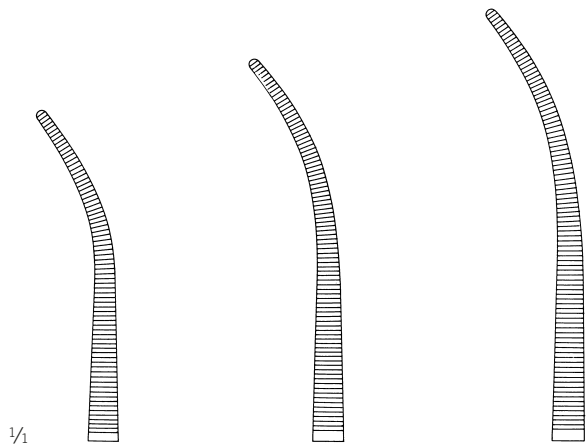

1/1

Fig. 1
13-577-19-07
19 cm / 7 7/8"

Fig. 1
13-577-22-07
22,5 cm / 8 7/8"

Fig. 1
13-577-24-07
23 cm / 9"

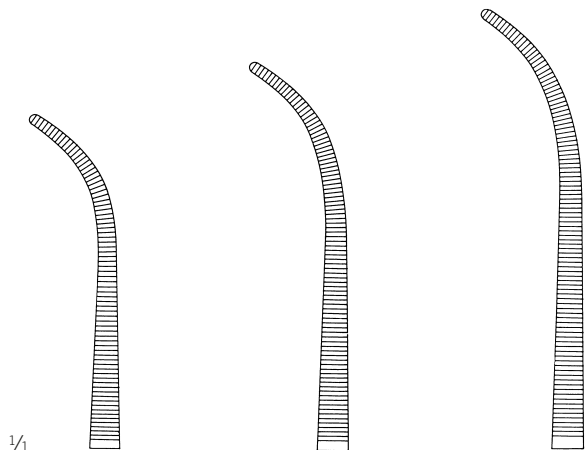

1/1

Fig. 2
13-579-19-07
19 cm / 7 7/8"

Fig. 2
13-579-22-07
22 cm / 8 5/8"

Fig. 2
13-579-24-07
23,5 cm / 9 1/8"

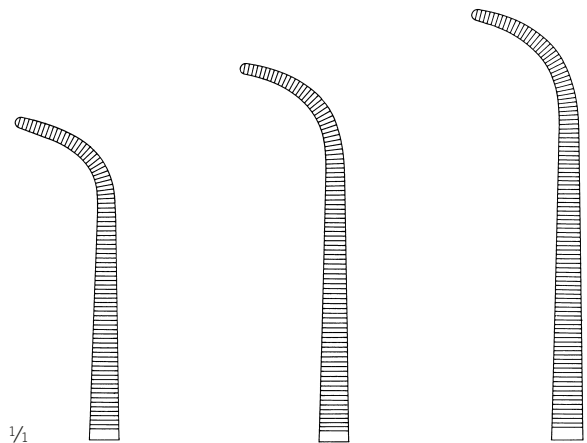

1/1

Fig. 3
13-581-19-07
18,5 cm / 7 3/8"

Fig. 3
13-581-22-07
21,5 cm / 8 4/8"

Fig. 3
13-581-24-07
23 cm / 9"



1/2

Kelly
13-577-19-07 -
13-581-24-07

Präparierklemmen, Arterienklemmen

Dissecting and Ligature Forceps, Haemostatic Forceps
Pinzas para preparación y ligadura, Pinzas hemostáticas
Pincas à disséquer et à ligatures, Pincas hémostatiques
Pinze per preparazioni e legature, Pinze emostatiche

Arterienklemmen

Haemostatic Forceps
Pinzas hemostáticas
Pincas hémostatiques
Pinze emostatiche



Lawrence
13-583-28-07
28 cm / 11"



Meeker
13-585-28-07
28 cm / 11"

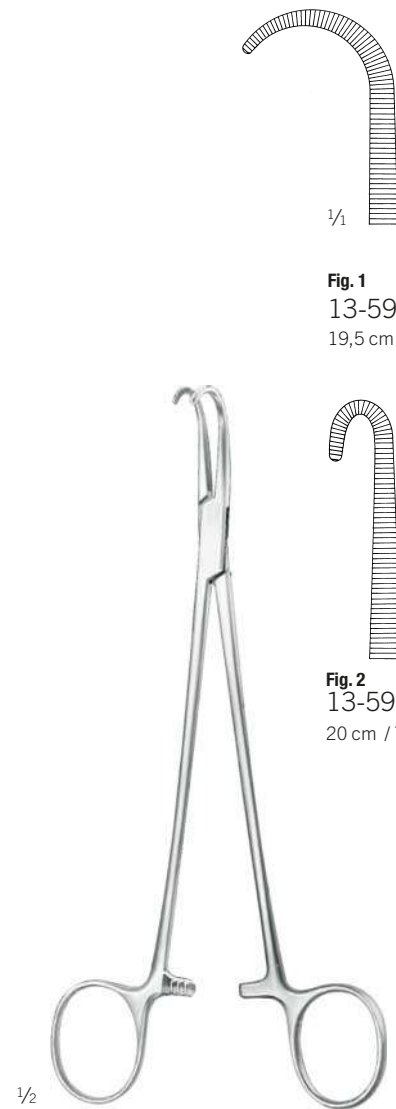

Negus
13-595-19-07 -
13-597-19-07

Fig. 1
13-595-19-07
19,5 cm / 7 5/8"

Fig. 2
13-597-19-07
20 cm / 7 7/8"

Hysterektomieklemmen

Hysterectomy Forceps
 Pinzas para histerectomía
 Pinces à hystérectomie
 Pinze per isterectomia



13-600-21-07
 20,5 cm / 8 1/8"

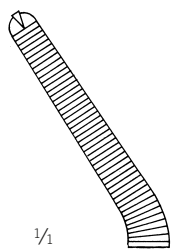

1/1

13-601-21-07
 20 cm / 7 7/8"

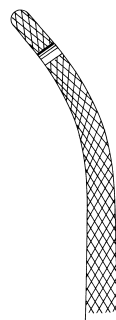

Fig. 1
 13-613-19-07
 19,5 cm / 7 5/8"

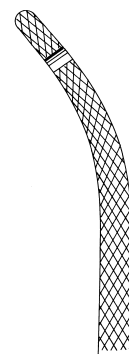

Fig. 1
 13-613-21-07
 21,5 cm / 8 4/8"

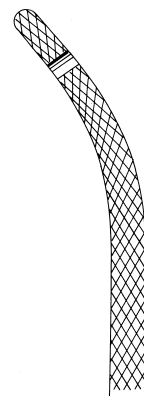
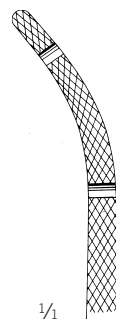

Fig. 1
 13-613-23-07
 24 cm / 9 4/8"



1/1

Fig. 2
 13-615-19-07
 19,5 cm / 7 5/8"

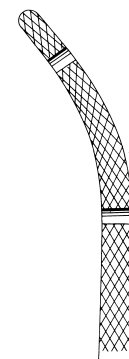

Fig. 2
 13-615-21-07
 21,5 cm / 8 4/8"

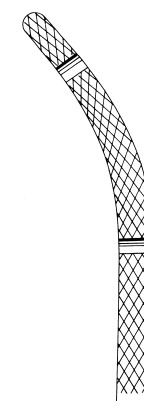

Fig. 2
 13-615-23-07
 24 cm / 9 4/8"



1/2

Phaneuf
 13-600-21-07 -
 13-601-21-07



1/2

Heaney
 13-613-19-07 -
 13-615-23-07

Vaginalklemmen

Vaginal Clamp
Pinzas vaginal
Pincas vaginales
Pinza vaginale

Arterienklemmen

Haemostatic Forceps
Pinzas hemostáticas
Pincas hémostatiques
Pinze emostatiche



$\frac{1}{2}$

Wertheim-Cullen
13-625-21-07
21 cm / 8 $\frac{2}{8}$ "

$\frac{1}{1}$

Hysterektomieklemmen

Hysterectomy Forceps
Pinzas para histerectomía
Pincers à hystérectomie
Pinze per isterectomia

Atrauma

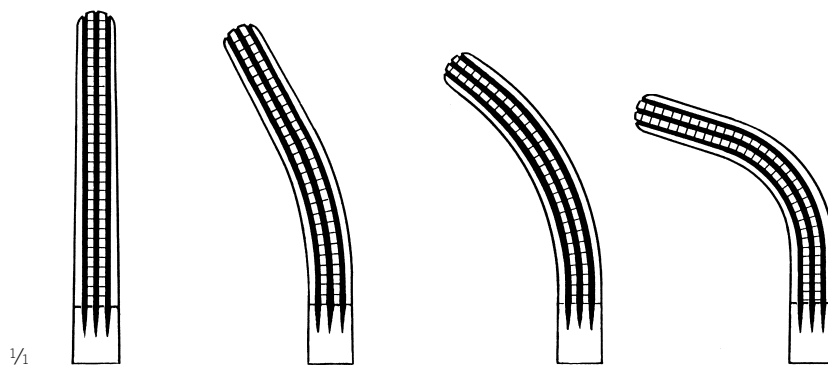

Fig. 1
13-635-10-07
21,5 cm / 8 4/8"

Fig. 2
13-635-20-07
21 cm / 8 2/8"

Fig. 3
13-635-30-07
21 cm / 8 2/8"

Fig. 4
13-635-40-07
20,5 cm / 8 1/8"

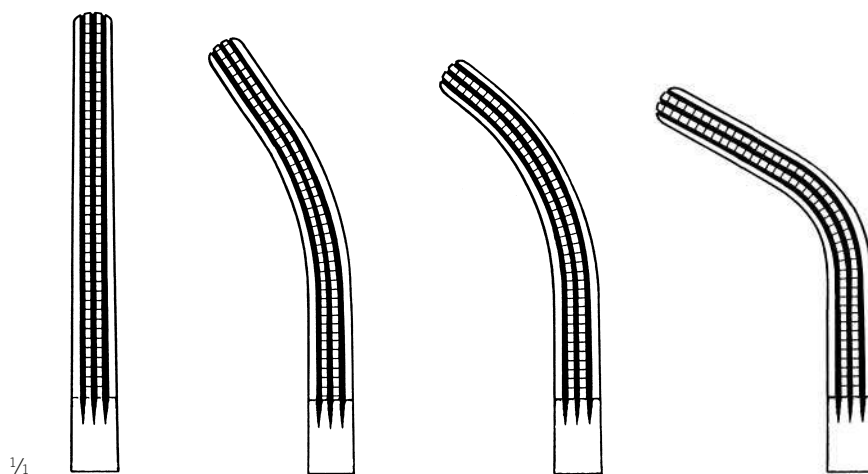

Fig. 1
13-637-10-07
25,5 cm / 10"

Fig. 2
13-637-20-07
25 cm / 9 7/8"

Fig. 3
13-637-30-07
24,5 cm / 9 4/8"

Fig. 4
13-637-35-07
24,5 cm / 9 4/8"



Rogers
13-635-10-07 -
13-637-35-07

Gallenkanalklemmen

Bile Duct Clamps
Pinzas para conducto biliar
Pincas pour les voies biliaires
Pinze per vie biliari

Arterienklemmen

Haemostatic Forceps
Pinzas hemostáticas
Pincas hémostatiques
Pinze emostatiche



Moynihan
13-671-23-07
23 cm / 9"

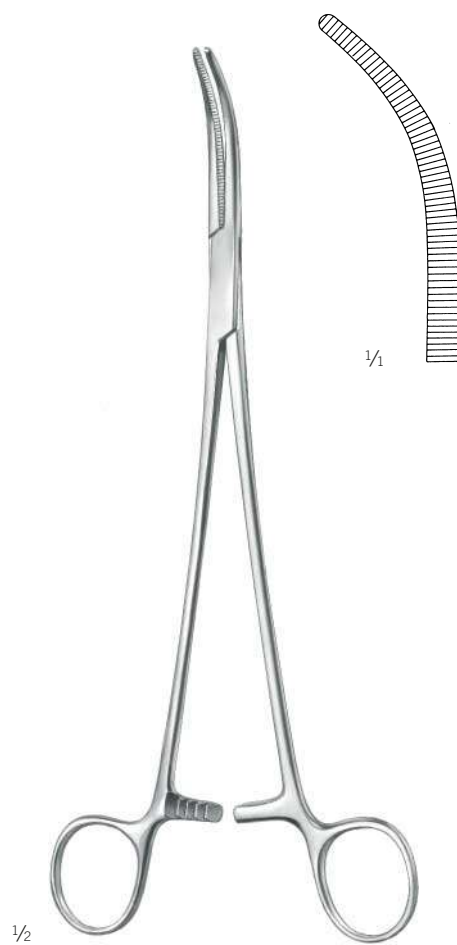

Moynihan
13-673-24-07
23,5 cm / 9 2/8"

Hysterektomieklemmen

Hysterectomy Forceps
Pinzas para histerectomía
Pinces à hystérectomie
Pinze per isterectomia



Wertheim
13-697-25-07
26 cm / 10 2/8"

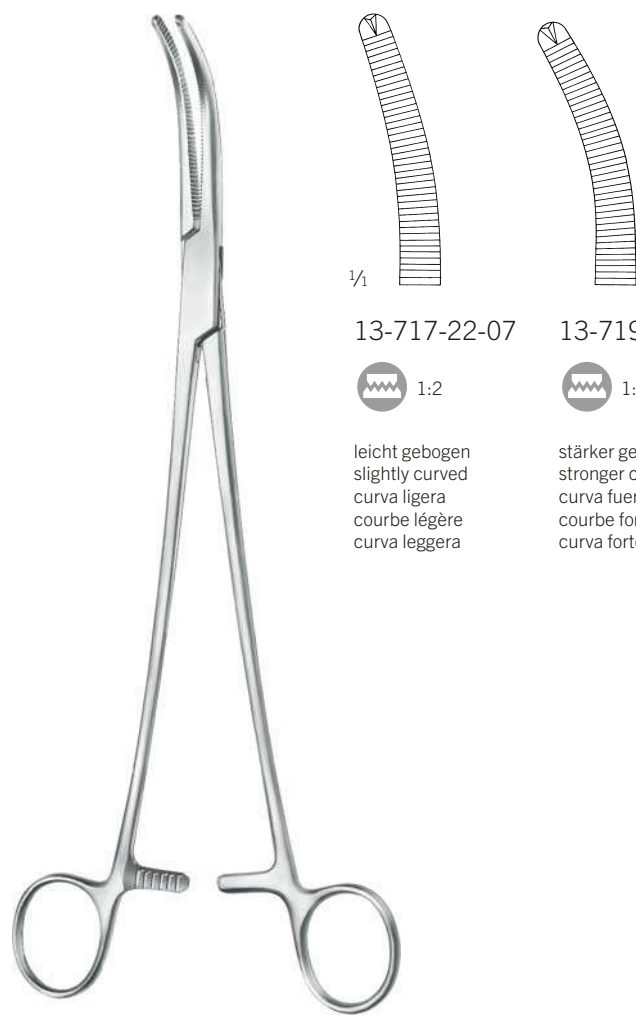

13-717-22-07

13-719-23-07



1:2



1:2

leicht gebogen
slightly curved
curva ligera
courbe légère
curva leggera

stärker gebogen
stronger curved
curva fuerte
courbe forte
curva forte

Peritoneumklemmen

Peritoneum Forceps
Pinzas para peritoneo
Pince pour le péritoine
Pinze per peritoneo

Arterienklemmen

Haemostatic Forceps
Pinzas hemostáticas
Pincas hémostatiques
Pinze emostatiche

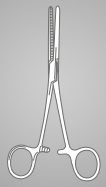

Mikulicz-Baby
13-721-14-07
14,5 cm / 5 9/16"



Mikulicz
13-725-18-07
18,5 cm / 7 3/8"

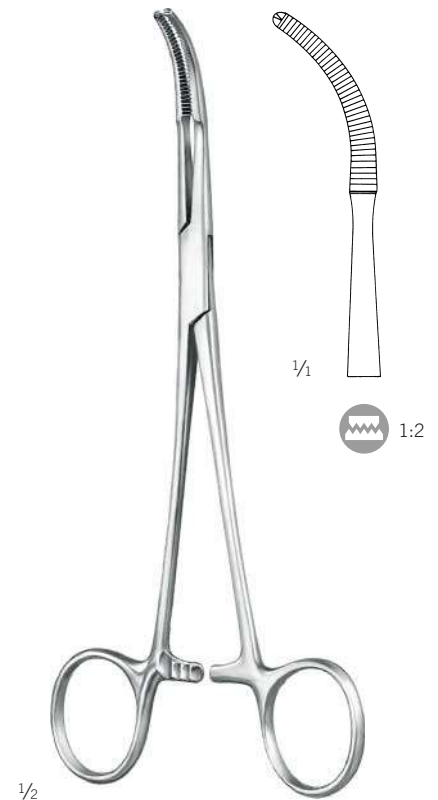

Mikulicz
13-727-20-07
20 cm / 7 7/8"

Peritoneumklemmen

Peritoneum Forceps
Pinzas para peritoneo
Pince pour le péritoine
Pinze per peritoneo

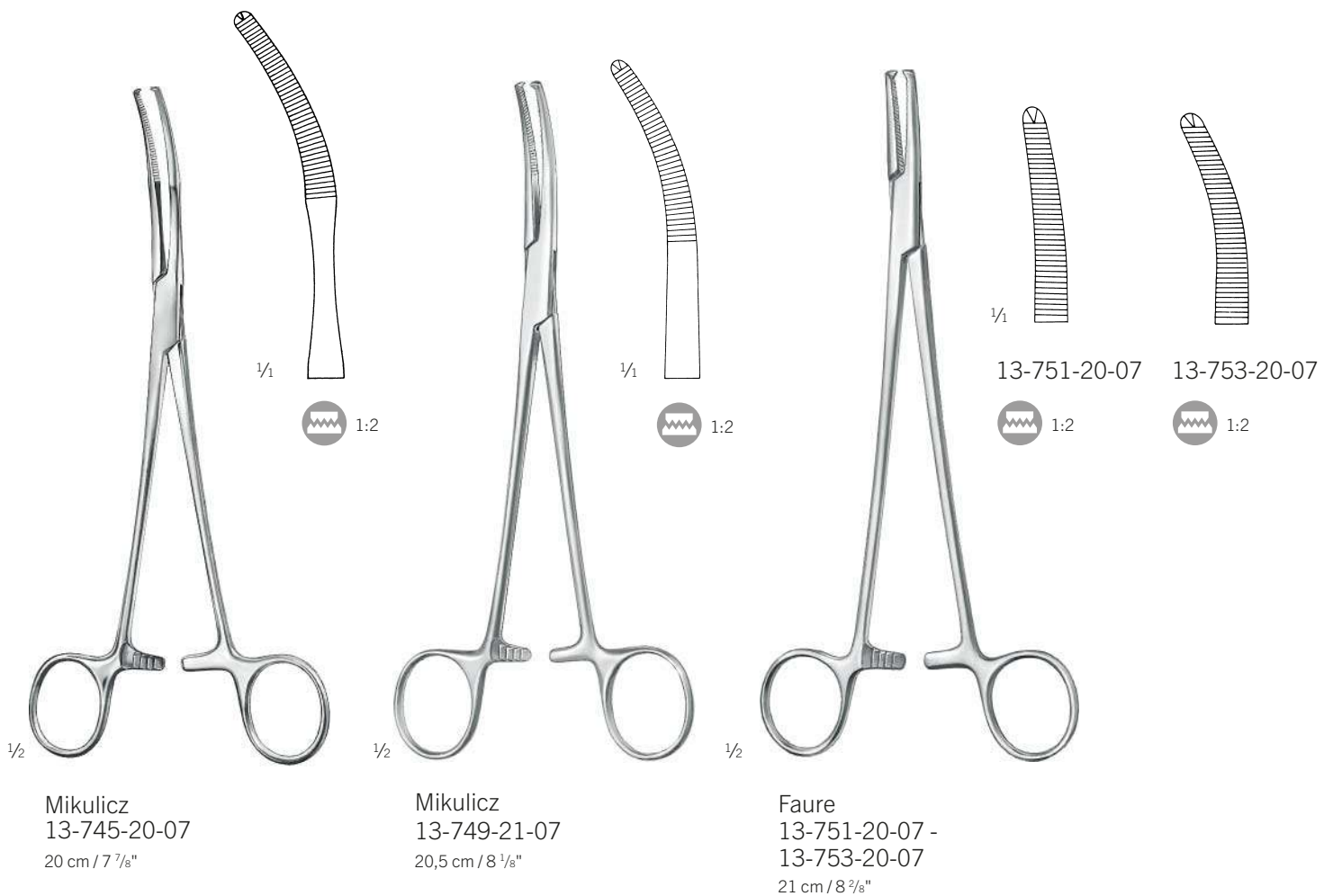

Tuchklemmen

Towel Clamps
Pinzas de campo
Pincas à champs
Pinze fissatele

Arterienklemmen

Haemostatic Forceps
Pinzas hemostáticas
Pincas hémostatiques
Pinze emostatiche



1/2

Schädel
13-875-09-07
9 cm / 3 4/8"
scharf
sharp
agudo
pointu
acuto



1/2

13-881-05-07
5,5 cm / 2 1/8"
13-881-09-07
8,5 cm / 3 3/8"
Jones
13-881-05-07 -
13-881-09-07
scharf
sharp
agudo
pointu
acuto

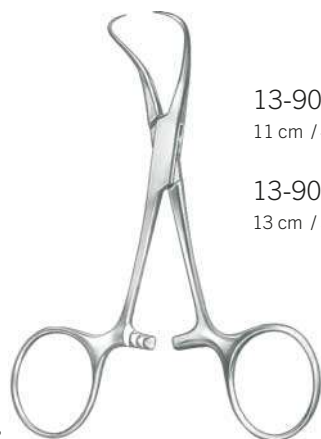

1/2

Backhaus
13-909-11-07 -
13-909-13-07
graziles Modell, scharf
delicate model, sharp
modelo delicado, aguda
modèle gracile, aiguë
modello delicato, acuto

13-909-11-07
11 cm / 4 3/8"
13-909-13-07
13 cm / 5 1/8"



1/2

Backhaus
13-913-11-07
11 cm / 4 3/8"
scharf, mit Schlauchhalter
sharp, with tube holder
agudo, con porta-tubo
pointu, avec clamp porte-tube
acuto, con porta-tubo



1/2

Backhaus
13-915-08-07 -
13-915-15-07
scharf
sharp
agudo
pointu
acuto



1/1

13-915-08-07
9 cm / 3 4/8"
13-915-11-07
11 cm / 4 3/8"
13-915-13-07
13 cm / 5 1/8"
13-915-15-07
16 cm / 6 2/8"

Tuchklemmen

Towel Clamps
Pinzas de campo
Pincas à champs
Pinze fissatele

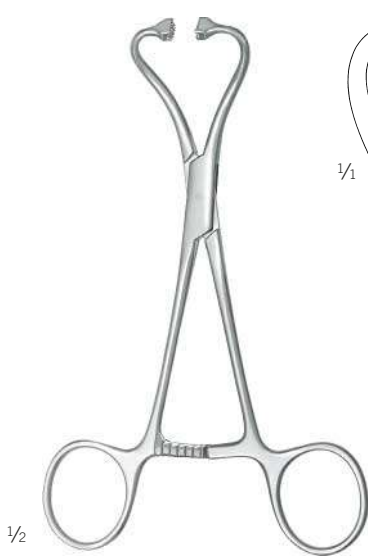

Peers-Bertram modif.
13-916-15-07

14,5 cm / 5 7/8"

weites Maul zur Schlauchfixierung
wide jaw for tube fixation
boca ancha para fijación de tubos
mors large pour fixation de tube
morso spalancato per fissare il tubo

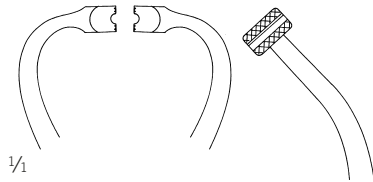

Roeder
13-917-13-07

13,5 cm / 5 3/8"



Lorna
13-919-10-07 -
13-919-13-07

fein gezahnt, breites Maul
fine serration, wide jaw
delicadamente dentada, boca ancha
avec dents fins, mors large
con denti fini, morso largo

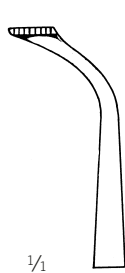

13-919-10-07
10 cm / 3 7/8"

13-919-13-07
13 cm / 5 1/8"



Bernhard
13-921-16-07

16,5 cm / 6 4/8"

scharf
sharp
agudo
pointu
acuto



Tohoku
13-923-10-07 -
13-923-13-07

stumpf
blunt
romo
mousse



13-923-10-07
10,5 cm / 4 1/8"

13-923-13-07
13,5 cm / 5 3/8"

Tuchklemmen, Schlauchklemmen

Towel Clamps, Tubing Clamps
Pinzas de campo, Pinzas para tubos
Pincas à champs, Pincas presse-tubes
Pinze fissatele, Pinze serratubi

Arterienklemmen

Haemostatic Forceps
Pinzas hemostáticas
Pincas hémostatiques
Pinze emostatiche

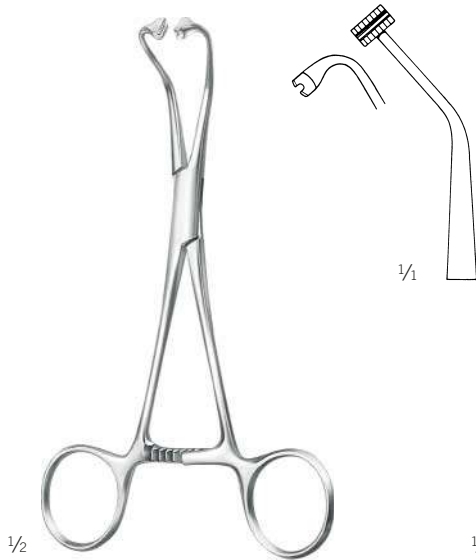

Peers-Bertram
13-923-14-07
14,5 cm / 5 7/8"

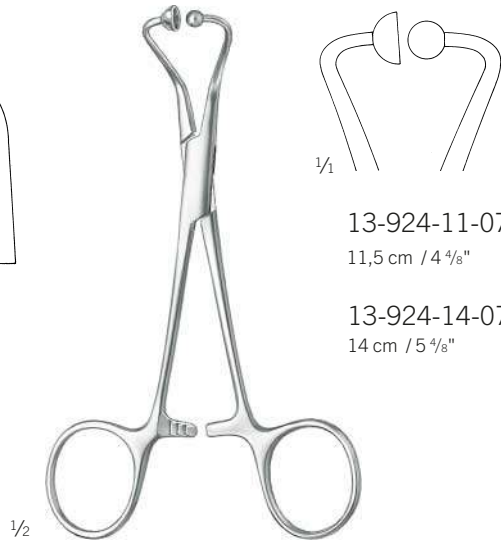

13-924-11-07 -
13-924-14-07

für Papierabdeckung
for paper drapes
para paños de papel
pour couverture en papier
per copertura di carta



Lane
13-935-20-07
19,5 cm / 7 5/8"

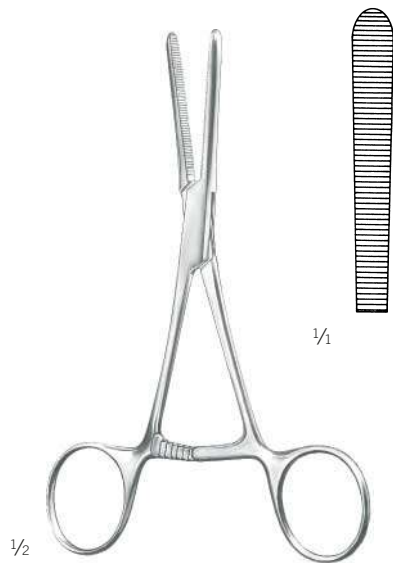

13-940-14-07
14 cm / 5 4/8"

extra lange Sperre
extra long ratchet
cremallera extra larga
cremaillère extrêmement longue
cremagliera stralunga

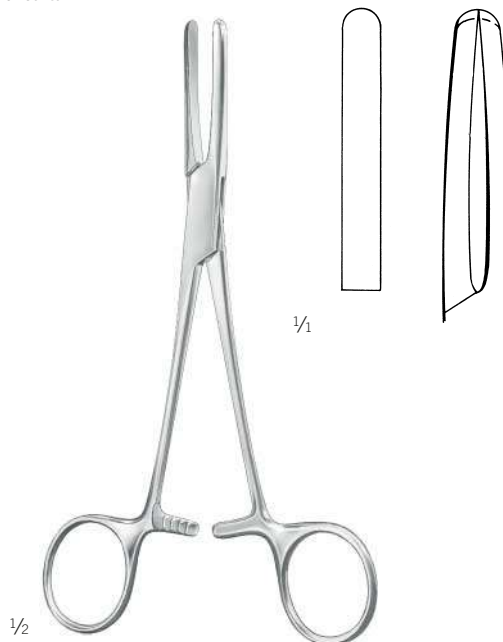

13-942-16-07
16,5 cm / 6 4/8"

glattes Maul
smooth jaw
boca lisa
mors lisse
morso liscio

Schlauchklemmen

Tubing Clamps

Pinzas para tubos

Pinces presse-tubes

Pinze serratubi



13-944-15-07 -
13-944-20-07

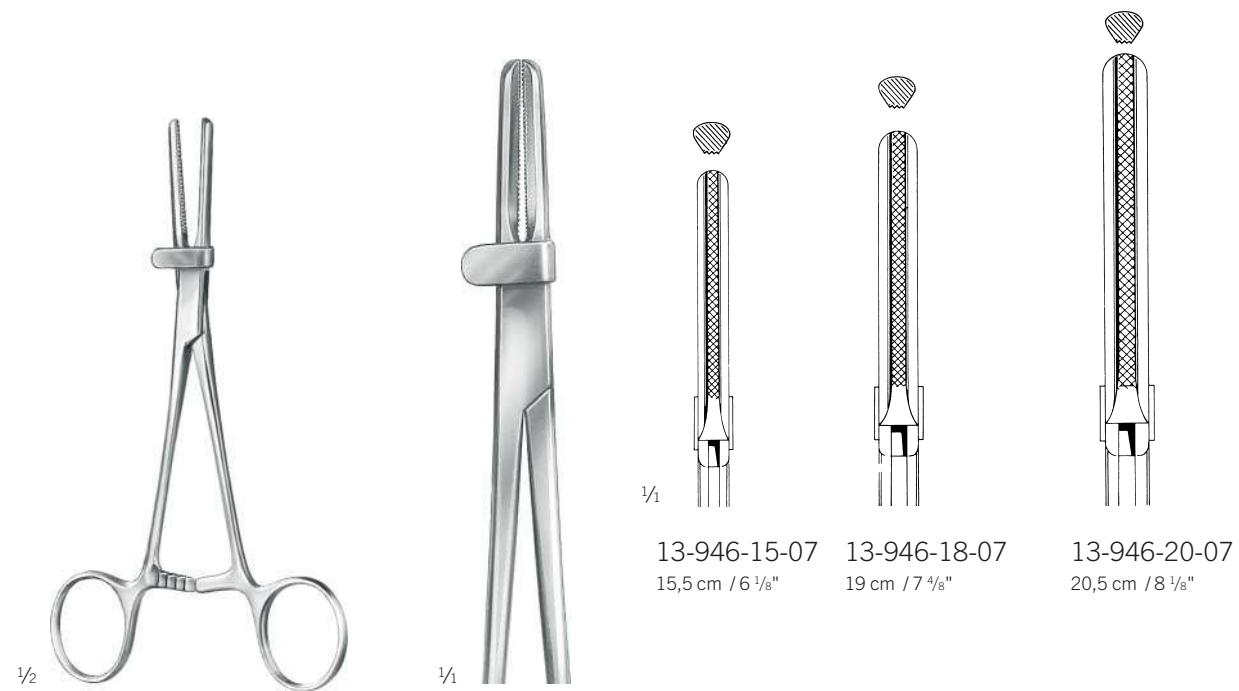

13-946-15-07 -
13-946-20-07

mit Schutzbügel
with safety guard
con stribo de protección
avec protection
con protezione

Schlauchklemmen

Tubing Clamps
Pinzas para tubos
Pincas presse-tubes
Pinze serratubi

Arterienklemmen

Haemostatic Forceps
Pinzas hemostáticas
Pincas hémostatiques
Pinze emostatiche



13



1/2

Brompton
13-948-01-04
16,5 cm / 6 1/8"

AI



1/2

Gunnar-Hey
13-948-02-07
18 cm / 7 1/8"

