

Pinzetten  
Forceps  
Pinzas  
Pincés  
Pinze

# 12









# Anatomische Pinzetten

Dissecting Forceps  
 Pinzas de disección  
 Pincès à dissection  
 Pinze per dissezione



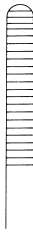
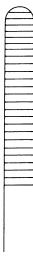

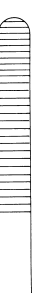
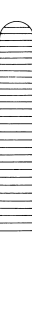



1/2

1/1					
	12-100-10-07 10,5 cm / 4 1/8"	12-100-11-07 11,5 cm / 4 7/8"	12-100-13-07 13 cm / 5 1/8"	12-100-14-07 14,5 cm / 5 7/8"	12-100-16-07 16 cm / 6 2/8"
1/1					
	12-100-18-07 18 cm / 7 1/8"	12-100-20-07 20 cm / 7 7/8"	12-100-23-07 23 cm / 9"	12-100-25-07 25 cm / 9 7/8"	12-100-30-07 30,5 cm / 12"

12-100-10-07 -  
12-100-30-07  
 Standardmodell  
 standard pattern  
 modelo estándar  
 modèle standard  
 modello standard

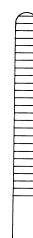

1/2

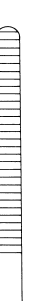
1/1					
	12-120-11-07 12 cm / 4 5/8"	12-120-13-07 13 cm / 5 1/8"	12-120-14-07 14,5 cm / 5 5/8"	12-120-16-07 16 cm / 6 2/8"	12-120-18-07 18 cm / 7 1/8"
1/1					
	12-120-20-07 20 cm / 7 7/8"	12-120-23-07 23 cm / 9"	12-120-25-07 25 cm / 9 7/8"	12-120-30-07 30 cm / 11 5/8"	

12-120-11-07 -  
12-120-30-07  
 mittelbreit  
 medium width  
 de anchura medio  
 demi-large  
 di media larghezza

# Anatomische Pinzetten

Dissecting Forceps  
Pinzas de disección  
Pincès à dissection  
Pinze per dissezione

# Pinzetten

Forceps  
Pinzas  
Pincès  
Pinze

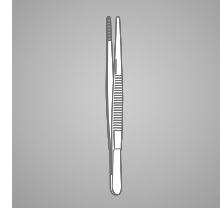

12

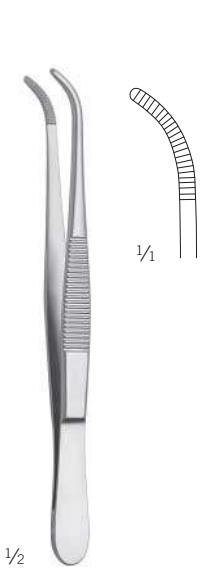

12-122-13-07  
13 cm / 5 1/8"

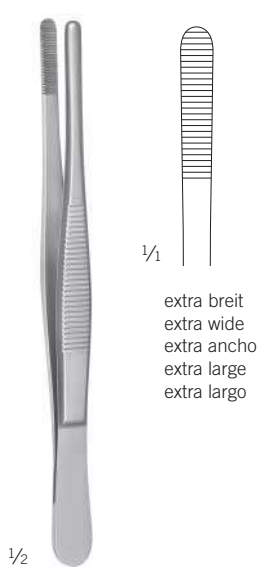

12-123-15-07  
14,5 cm / 5 6/8"

extra breit  
extra wide  
extra ancho  
extra large  
extra largo



12-126-13-07 -  
12-126-14-07

12-126-13-07  
13 cm / 5 1/8"



12-126-14-07  
14,5 cm / 5 6/8"

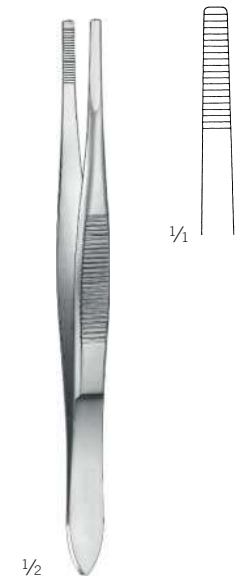

Stille  
12-130-15-07  
15 cm / 5 7/8"

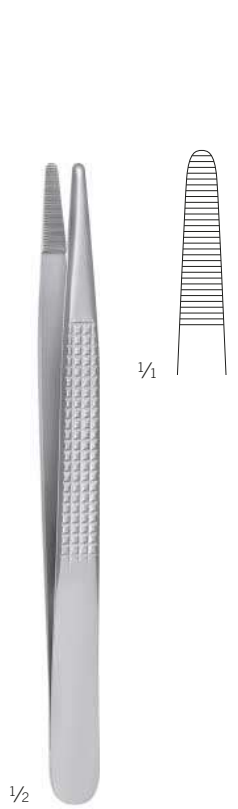

Bonney  
12-131-17-07  
17 cm / 6 5/8"



12-132-19-07  
18,5 cm / 7 2/8"



12-134-20-07  
20 cm / 7 7/8"

# Anatomische Pinzetten

Dissecting Forceps  
 Pinzas de disección  
 Pinces à dissection  
 Pinze per dissezione

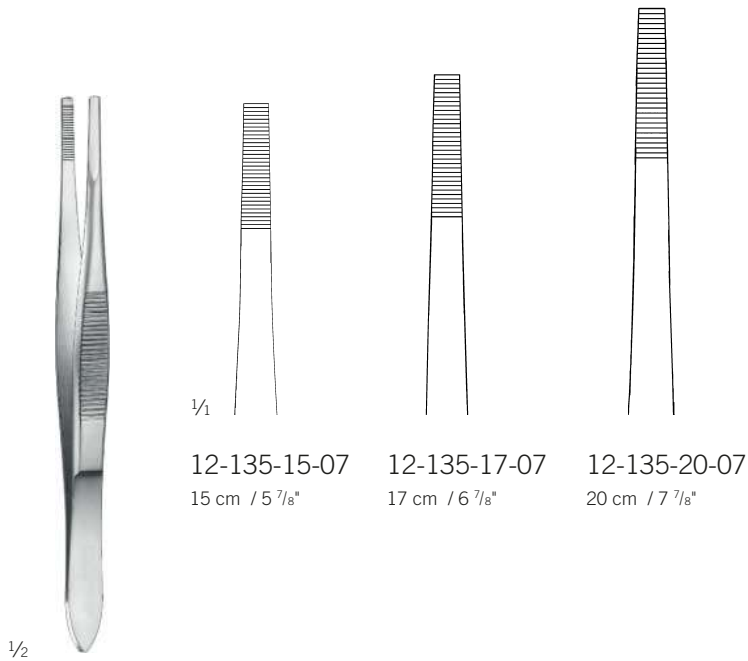

Schweden-Modell  
 12-135-15-07 -  
 12-135-20-07

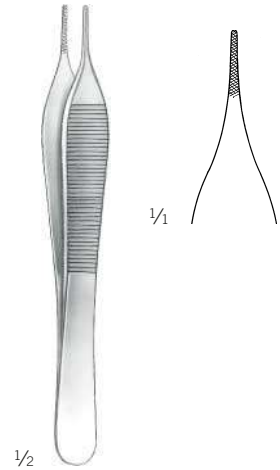

Mini-Adson  
 12-166-12-07  
 12 cm / 4 6/8"

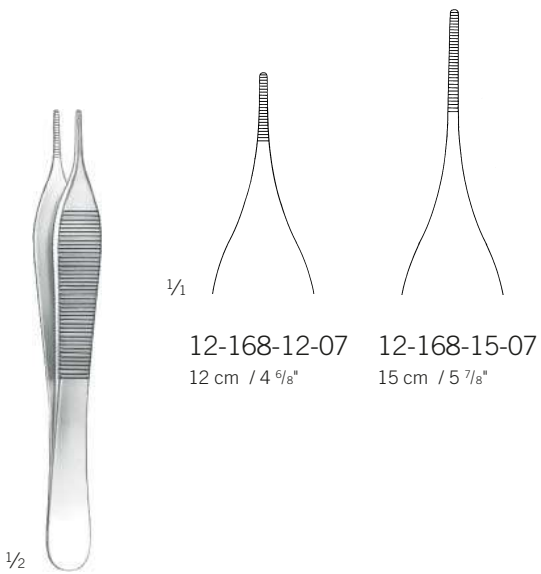

Adson  
 12-168-12-07 -  
 12-168-15-07

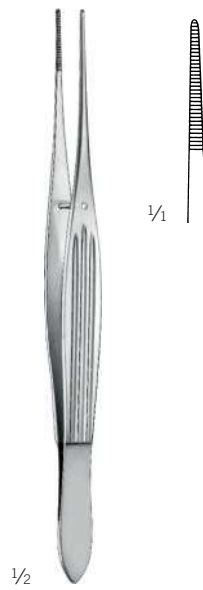

McIndoe  
 12-170-15-07  
 15 cm / 5 7/8"



Waugh  
 12-171-20-07  
 20 cm / 7 7/8"

## Anatomische Pinzetten

Dissecting Forceps  
Pinzas de disección  
Pincès à dissection  
Pinze per dissezione

## Pinzetten

Forceps  
Pinzas  
Pincès  
Pinze

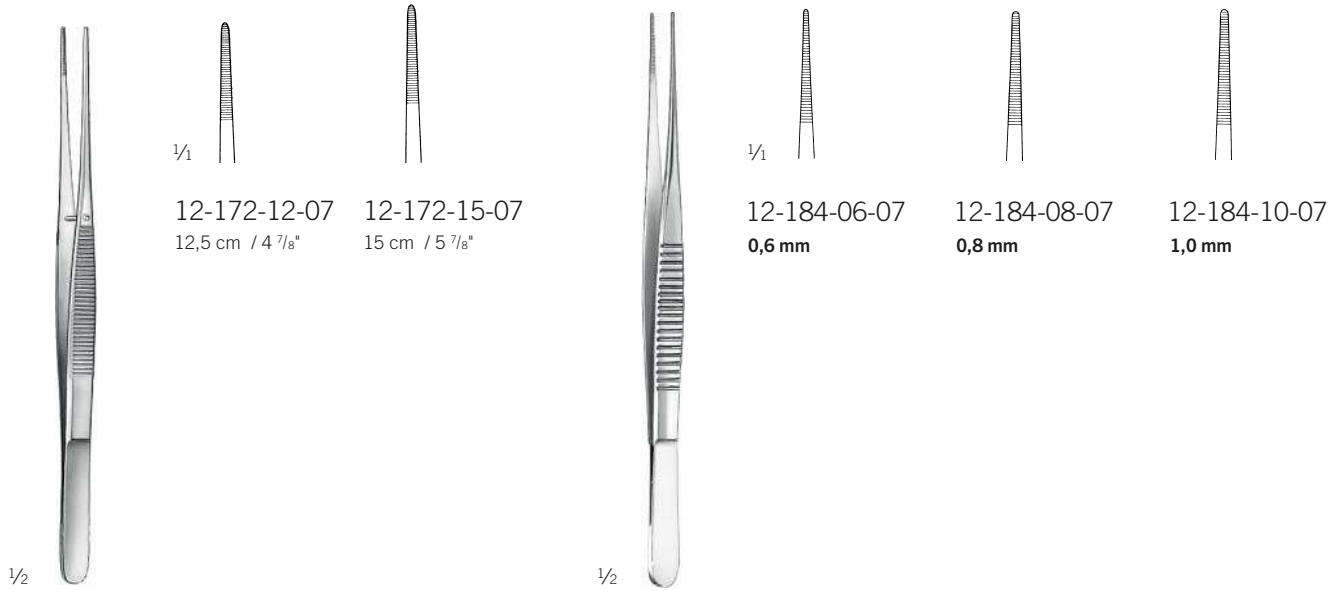
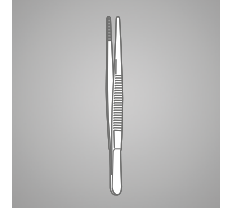

12-172-12-07  
12,5 cm / 4 <sup>7</sup>/<sub>8</sub>"

12-172-15-07  
15 cm / 5 <sup>7</sup>/<sub>8</sub>"

12-184-06-07  
0,6 mm

12-184-08-07  
0,8 mm

12-184-10-07  
1,0 mm

Semken  
12-172-12-07 -  
12-172-15-07

12-184-06-07 -  
12-184-10-07  
15,5 cm / 6 <sup>1</sup>/<sub>8</sub>"

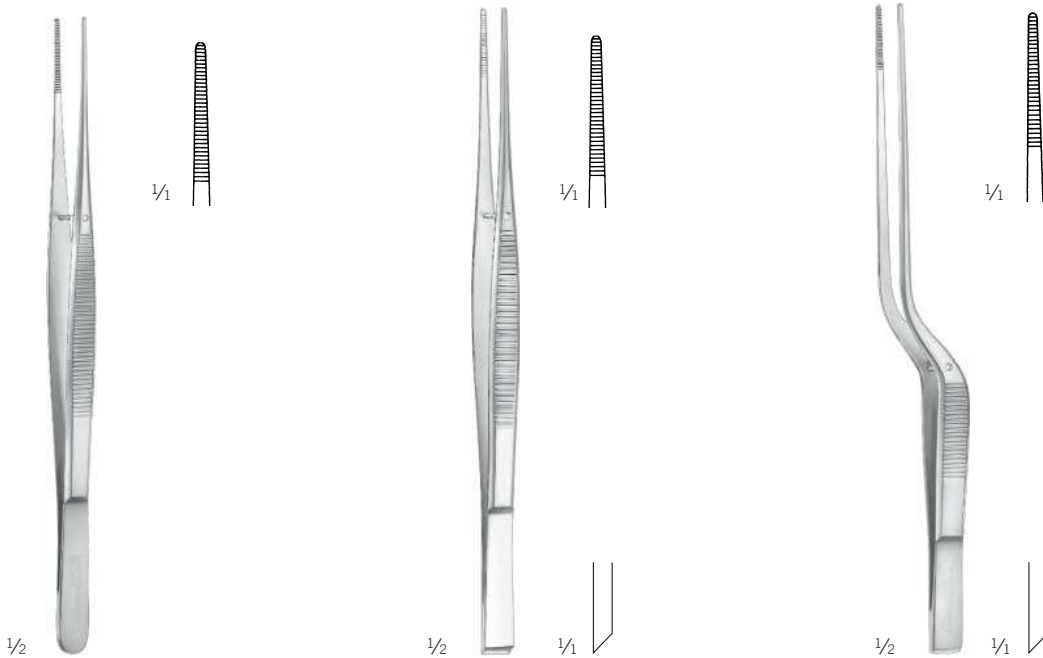

Taylor  
12-174-17-07  
17 cm / 6 <sup>6</sup>/<sub>8</sub>"

Taylor  
12-180-17-07  
17,5 cm / 6 <sup>7</sup>/<sub>8</sub>"  
mit Schaberende  
with dissector end  
con rascador  
à rugine  
con estremita a forma di raschino

Taylor  
12-183-17-07  
18,5 cm / 7 <sup>2</sup>/<sub>8</sub>"  
mit Schaberende  
with dissector end  
con rascador  
à rugine  
con estremita a forma di raschino

12

# Anatomische Pinzetten

Dissecting Forceps  
 Pinzas de disección  
 Pinces à dissection  
 Pinze per dissezione

## Atrauma

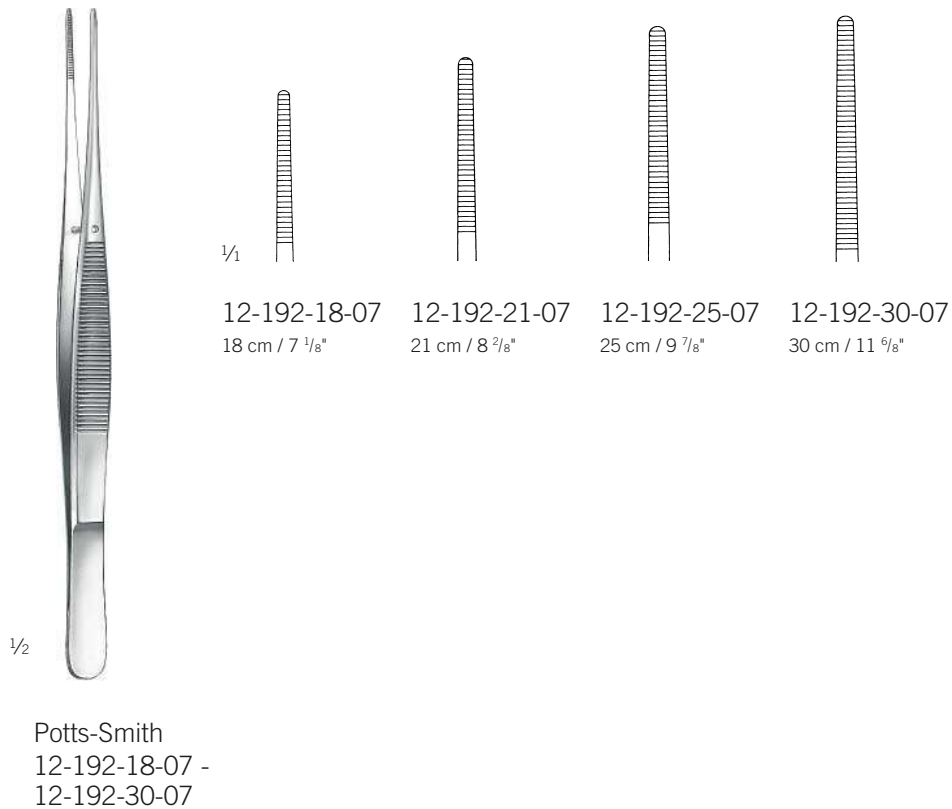
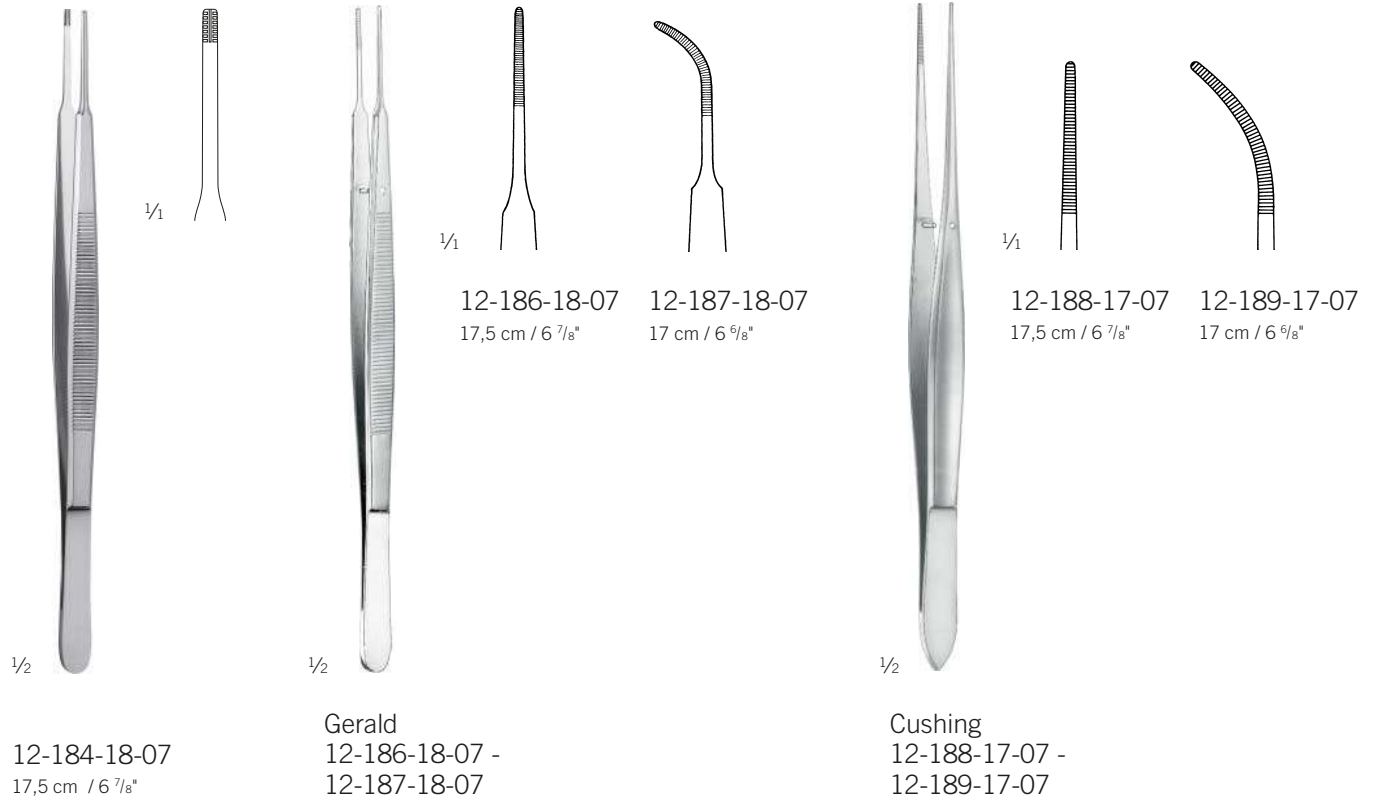

# Chirurgische Pinzetten, Anatomische Pinzetten

Tissue Forceps, Dissecting Forceps

Pinzas de disección con diente, Pinzas de disección

Pinces à dissection à griffes, Pinces à dissection

Pinze per dissezione con denti, Pinze per dissezione

## Pinzetten

Forceps

Pinzas

Pinces

Pinze

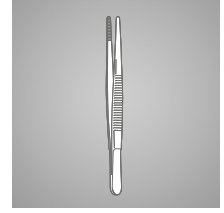

## TC GOLD

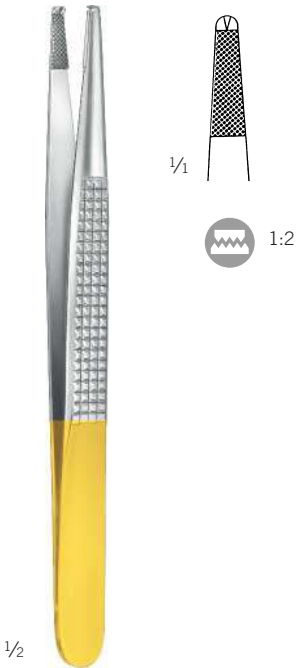

**Bonney**  
12-230-17-07  
17,5 cm / 6 7/8"  
Normalprofil  
standard profile  
perfil estándar  
profil normal  
profilo normale



**Gerald**  
12-234-17-07  
17,5 cm / 6 7/8"  
Normalprofil  
standard profile  
perfil estándar  
profil normal  
profilo normale



**Gillies**  
12-236-15-07  
15,5 cm / 6 1/8"  
Miniprofil  
mini profile  
perfil mini  
profil mini  
mini-profilo



**McIndoe**  
12-238-15-07  
15 cm / 5 7/8"  
Miniprofil  
mini profile  
perfil mini  
profil mini  
mini-profilo



**Semken**  
12-240-16-07 -  
12-242-18-07

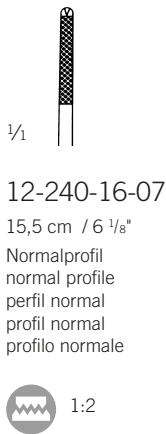

12-240-16-07  
15,5 cm / 6 1/8"  
Normalprofil  
normal profile  
perfil normal  
profil normal  
profilo normale

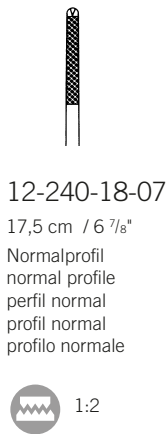

12-240-18-07  
17,5 cm / 6 7/8"  
Normalprofil  
normal profile  
perfil normal  
profil normal  
profilo normale



12-242-16-07  
15,5 cm / 6 1/8"  
Miniprofil  
mini profile  
perfil mini  
profil mini  
mini-profilo



12-242-18-07  
17,5 cm / 6 7/8"  
Miniprofil  
mini profile  
perfil mini  
profil mini  
mini-profilo

12

# Chirurgische Pinzetten, Anatomische Pinzetten

Tissue Forceps, Dissecting Forceps

Pinzas de disección con diente, Pinzas de disección

Pinces à dissection à griffes, Pinces à dissection

Pinze per dissezione con denti, Pinze per dissezione

## TC GOLD

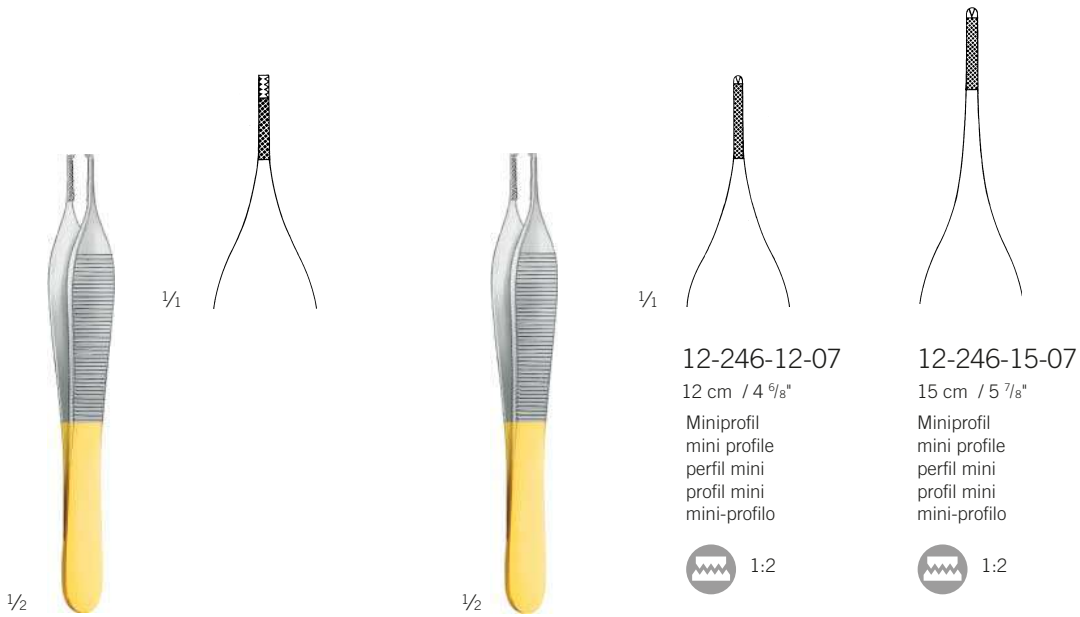

Adson-Brown  
12-244-12-07

12 cm / 4 5/8"

Normalprofil  
normal profile  
perfil normal  
profil normal  
profilo normale

Adson  
12-246-12-07 -  
12-246-15-07

12-246-12-07

12 cm / 4 5/8"

Miniprofil  
mini profile  
perfil mini  
profil mini  
mini-profilo



12-246-15-07

15 cm / 5 7/8"

Miniprofil  
mini profile  
perfil mini  
profil mini  
mini-profilo

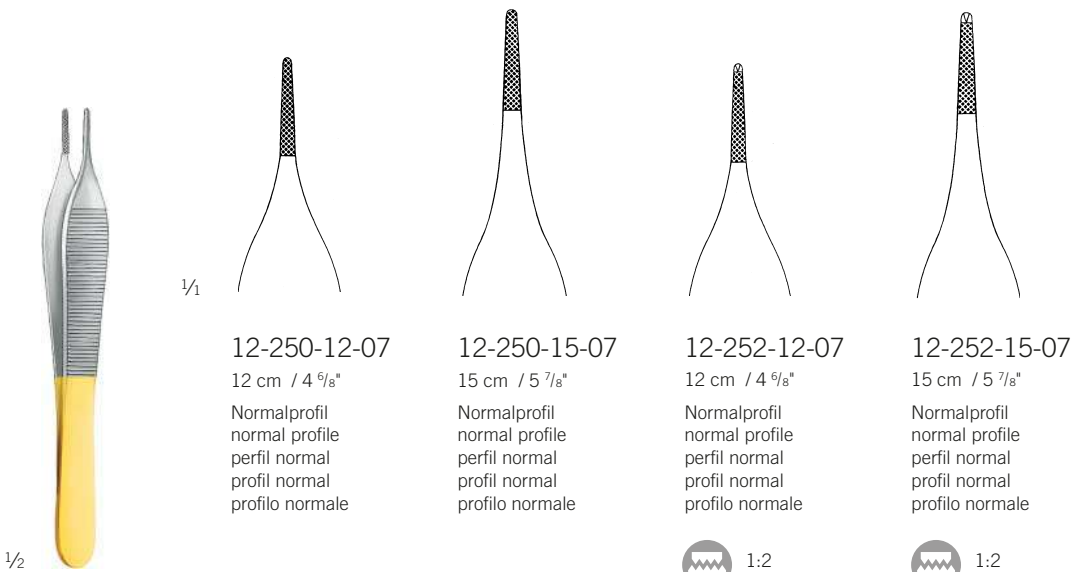

Adson  
12-250-12-07 -  
12-252-15-07

12-250-12-07

12 cm / 4 5/8"

Normalprofil  
normal profile  
perfil normal  
profil normal  
profilo normale

12-250-15-07

15 cm / 5 7/8"

Normalprofil  
normal profile  
perfil normal  
profil normal  
profilo normale

12-252-12-07

12 cm / 4 5/8"

Normalprofil  
normal profile  
perfil normal  
profil normal  
profilo normale

12-252-15-07

15 cm / 5 7/8"

Normalprofil  
normal profile  
perfil normal  
profil normal  
profilo normale



# Anatomische Pinzetten

Dissecting Forceps  
 Pinzas de disección  
 Pincès à dissection  
 Pinze per dissezione

# Pinzetten

Forceps  
 Pinzas  
 Pincès  
 Pinze

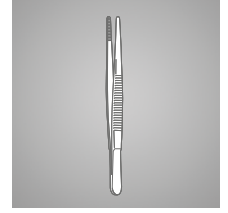

## TC GOLD

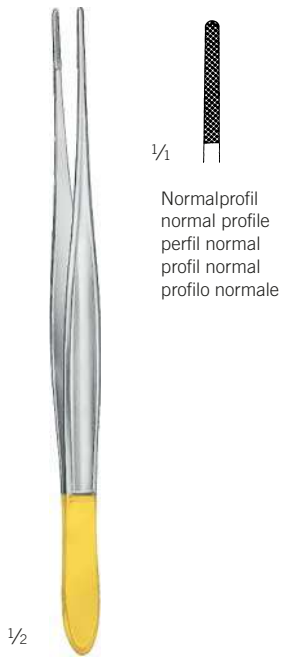

Normalprofil  
 normal profile  
 perfil normal  
 profil normal  
 profilo normale

Cushing  
 12-254-17-07  
 17,5 cm / 6 7/8"



Normalprofil  
 normal profile  
 perfil normal  
 profil normal  
 profilo normale

Cushing  
 12-255-18-07  
 17 cm / 6 5/8"

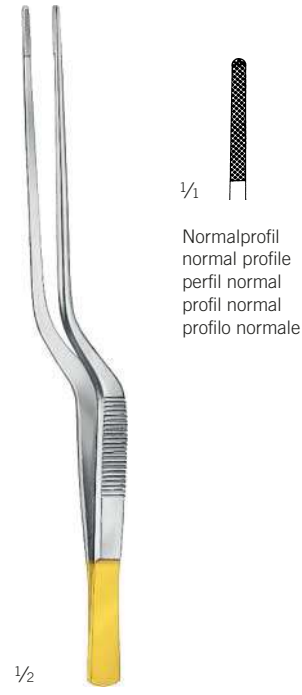

Normalprofil  
 normal profile  
 perfil normal  
 profil normal  
 profilo normale

Cushing-Taylor  
 12-256-18-07  
 18,5 cm / 7 1/8"

12

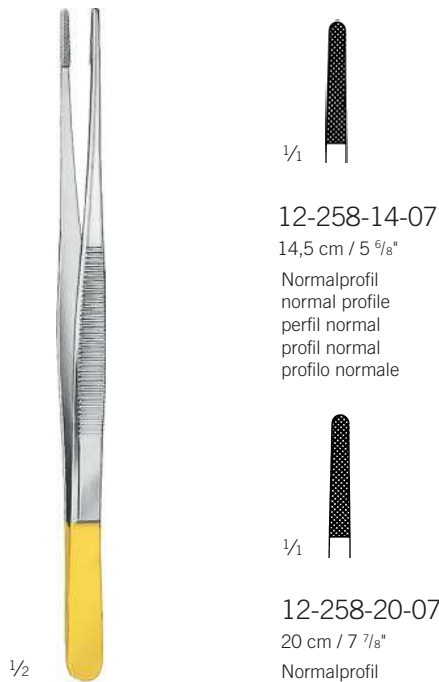

Potts-Smith  
 12-258-14-07 -  
 12-258-25-07



# Chirurgische Pinzetten, Anatomische Pinzetten

Tissue Forceps, Dissecting Forceps

Pinzas de disección con diente, Pinzas de disección

Pinces à dissection à griffes, Pinces à dissection

Pinze per dissezione con denti, Pinze per dissezione

## TC GOLD



1/2

1/1				
<b>12-260-14-07</b> 14,5 cm / 5 7/8" Normalprofil normal profile perfil normal profil normal profilo normale	<b>12-260-16-07</b> 16 cm / 6 2/8" Normalprofil normal profile perfil normal profil normal profilo normale	<b>12-260-18-07</b> 18 cm / 7 1/8" Normalprofil normal profile perfil normal profil normal profilo normale	<b>12-260-20-07</b> 20 cm / 7 7/8" Normalprofil normal profile perfil normal profil normal profilo normale	<b>12-260-25-07</b> 25 cm / 9 7/8" Normalprofil normal profile perfil normal profil normal profilo normale
1:2	1:2	1:2	1:2	1:2

Oehler  
12-260-14-07 -  
12-260-25-07



1/2

1/1	1/1
<b>12-266-15-07</b> 15 cm / 5 7/8" Normalprofil normal profile perfil normal profil normal profilo normale	<b>12-266-23-07</b> 23 cm / 9" Normalprofil normal profile perfil normal profil normal profilo normale

Wangenstein  
12-266-15-07 -  
12-266-23-07



1/2



1/1

Kübler  
12-267-20-07  
20 cm / 7"

# Anatomische Pinzetten

Dissecting Forceps  
Pinzas de disección  
Pincés à dissection  
Pinze per dissezione

# Pinzetten

Forceps  
Pinzas  
Pincés  
Pinze

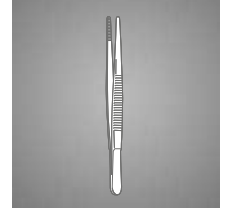

## TC GOLD Atrauma

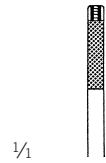

	Miniprofil mini profile perfil mini profil mini mini-profilo
	<b>2,0 mm</b>
16 cm / 6 2/8"	12-272-15-07
20 cm / 7 7/8"	12-272-19-07
24,5 cm / 9 5/8"	12-272-24-07

1/2

DeBakey  
12-272-15-07 -  
12-272-24-07



1/2

Jaboma  
12-276-18-07  
18 cm / 7 1/8"



1/2

Jaboma  
12-278-18-07  
18 cm / 7 1/8"

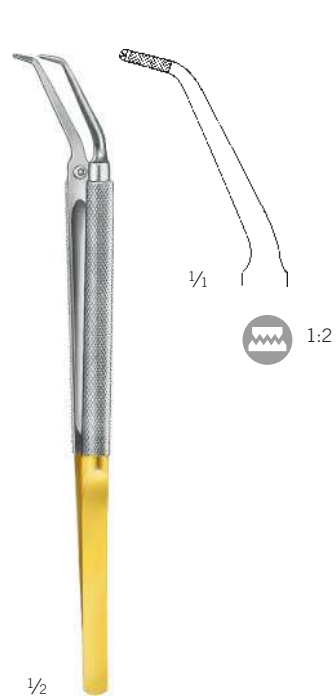

1/2

Jaboma  
12-279-18-07  
18 cm / 7 1/8"

## Anatomische Pinzetten, Atraumatische Pinzetten

Dissecting Forceps, Atraumatic Dissecting Forceps

Pinzas de disección, Pinzas de disección atraumática

Pinces à dissection, Pinces atraumatiques à dissection

Pinze per dissezione, Pinze atraumatiche



1/2

### Atrauma



1/4



	1,5 mm	1,8 mm
16 cm / 6 2/8"	12-282-16-09	12-284-16-09
20,5 cm / 8 1/8"	12-282-20-09	12-284-20-09
24,5 cm / 9 5/8"	12-282-24-09	12-284-24-09

DeBakey  
12-282-16-09 -  
12-284-24-09



1/2



1/4

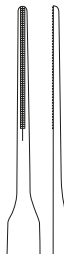

	Atrauma		
	Ø 1,2 mm	1,0 x 0,5 mm	1,0 mm
18 cm / 7 1/8"	St 12-285-18-07	12-286-18-07	12-287-18-07
20 cm / 7 7/8"	St 12-285-20-07	12-286-20-07	12-287-20-07

Gerald  
12-285-18-07 -  
12-287-20-07

# Chirurgische Pinzetten

Tissue Forceps  
 Pinzas de disección con diente  
 Pincès à dissection à griffes  
 Pinze per dissezione con denti

# Pinzetten

Forceps  
 Pinzas  
 Pincès  
 Pinze

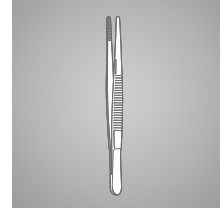

12

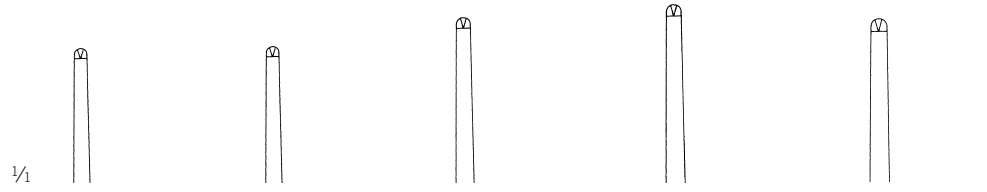

12-301-10-07 10,5 cm / 4 1/8"	12-301-11-07 12 cm / 4 7/8"	12-301-13-07 13 cm / 5 1/8"	12-301-14-07 14,5 cm / 5 7/8"	12-301-16-07 16 cm / 6 2/8"
1:2	1:2	1:2	1:2	1:2

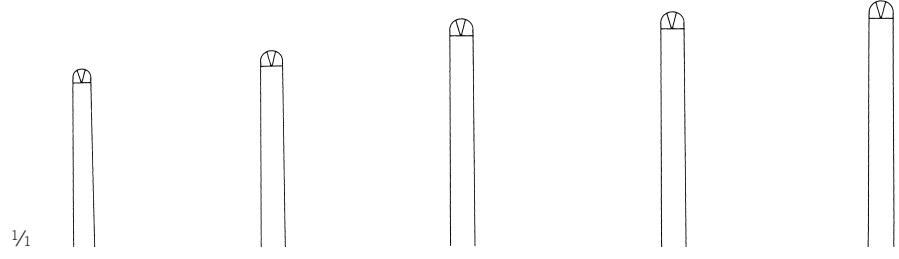

12-301-10-07 -  
 12-301-30-07  
 Standardmodell  
 standard pattern  
 modelo estándar  
 modèle standard  
 modello standard

12-301-18-07 18 cm / 7 1/8"	12-301-20-07 20,5 cm / 8 1/8"	12-301-23-07 23 cm / 9"	12-301-25-07 25 cm / 9 7/8"	12-301-30-07 30,5 cm / 12"
1:2	1:2	1:2	1:2	1:2

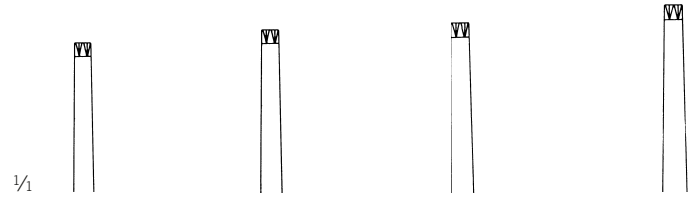

12-302-11-07 12 cm / 4 5/8"	12-302-13-07 13 cm / 5 1/8"	12-302-14-07 14,5 cm / 5 7/8"	12-302-16-07 16 cm / 6 2/8"
2:3	2:3	2:3	2:3

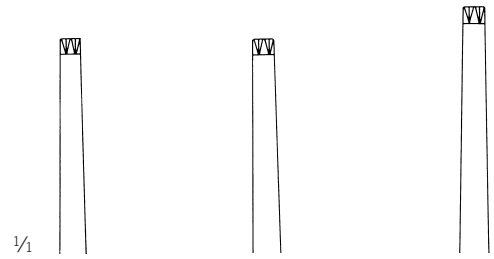

12-302-11-07 -  
 12-302-25-07

12-302-18-07 18 cm / 7 1/8"	12-302-20-07 20,5 cm / 8 1/8"	12-302-25-07 25 cm / 9 7/8"
2:3	2:3	2:3

# Chirurgische Pinzetten

Tissue Forceps

Pinzas de disección con diente

Pinces à dissection à griffes

Pinze per dissezione con denti

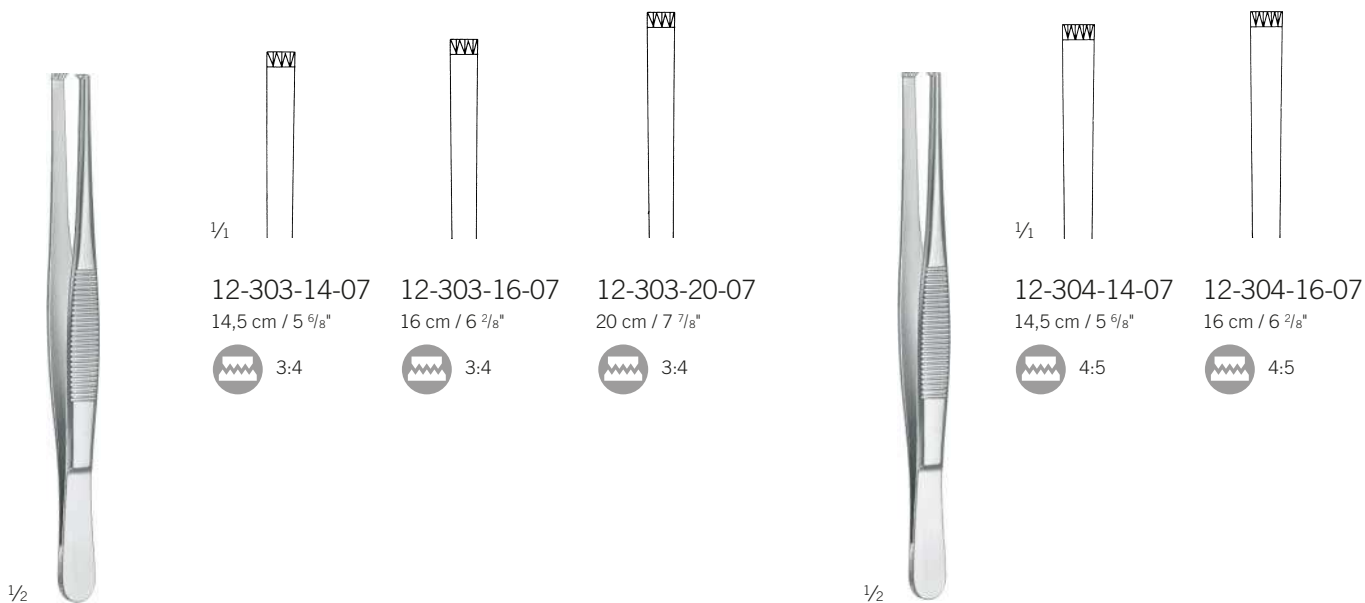

12-303-14-07 -  
12-303-20-07

12-304-14-07 -  
12-304-16-07



12-321-13-07 -  
12-321-30-07

mittelbreit  
medium  
medio  
moyen  
medio

# Chirurgische Pinzetten

Tissue Forceps  
 Pinzas de disección con diente  
 Pincers à dissection à griffes  
 Pinze per dissezione con denti

# Pinzetten

Forceps  
 Pinzas  
 Pincers  
 Pinze

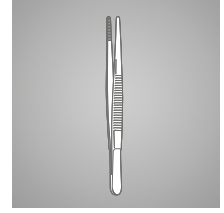

12

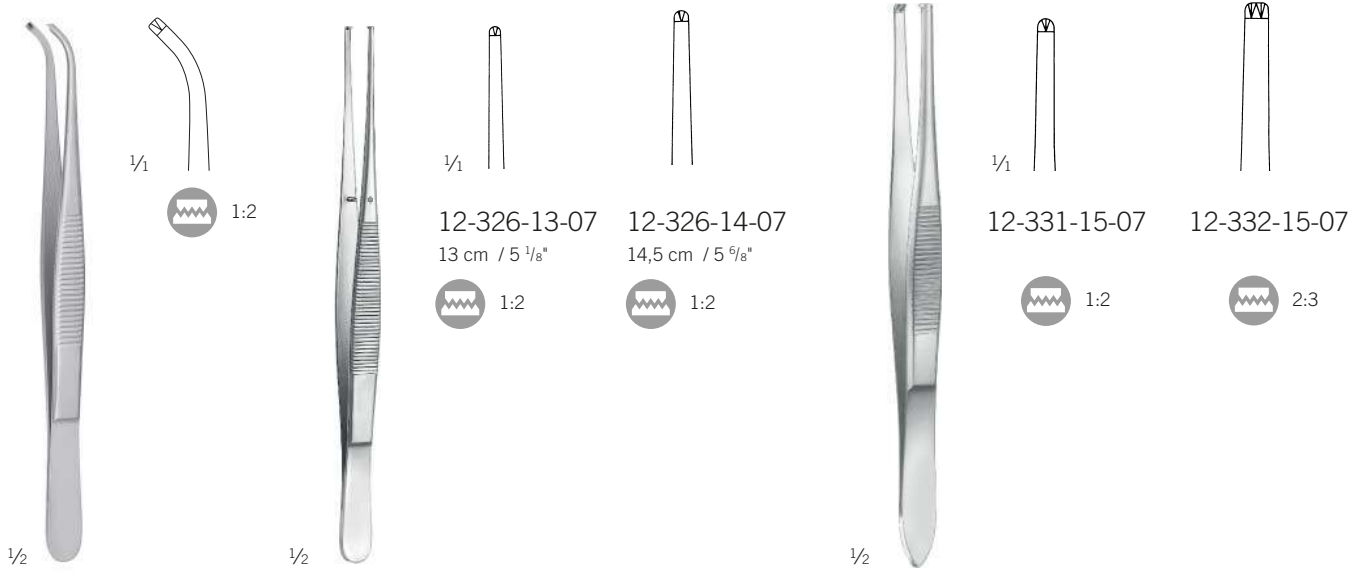

12-323-15-07  
 14,5 cm / 5 7/8"

12-326-13-07 -  
 12-326-14-07

Stille  
 12-331-15-07 -  
 12-332-15-07  
 15 cm / 5 7/8"

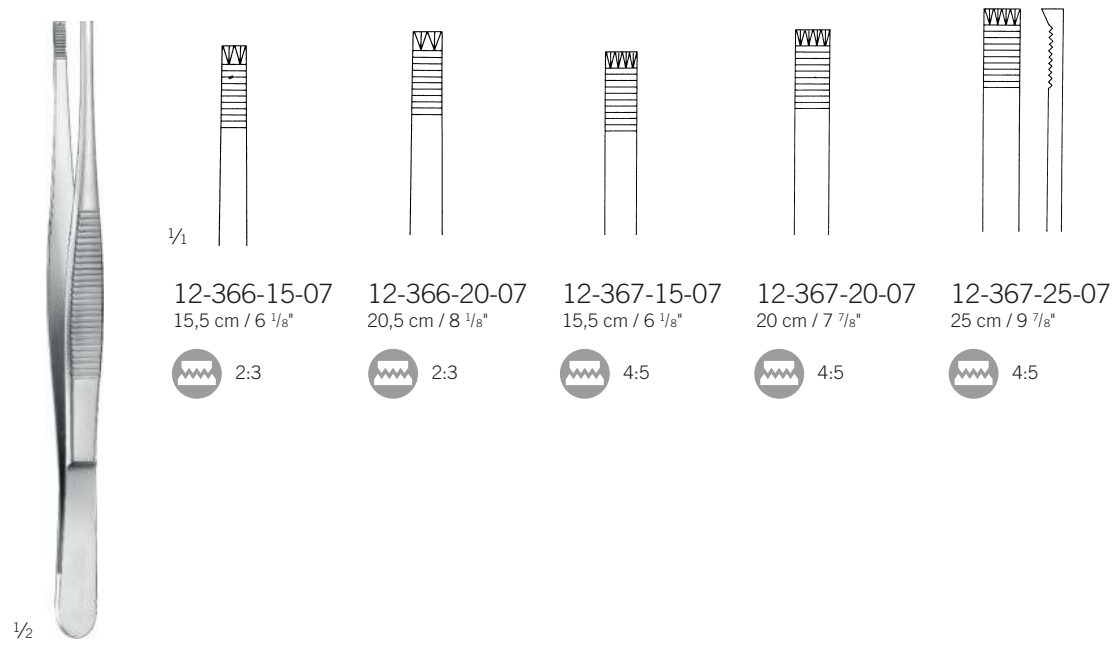

Adlerkreutz  
 12-366-15-07 -  
 12-367-25-07

# Chirurgische Pinzetten

Tissue Forceps

Pinzas de disección con diente

Pinces à dissection à griffes

Pinze per dissezione con denti

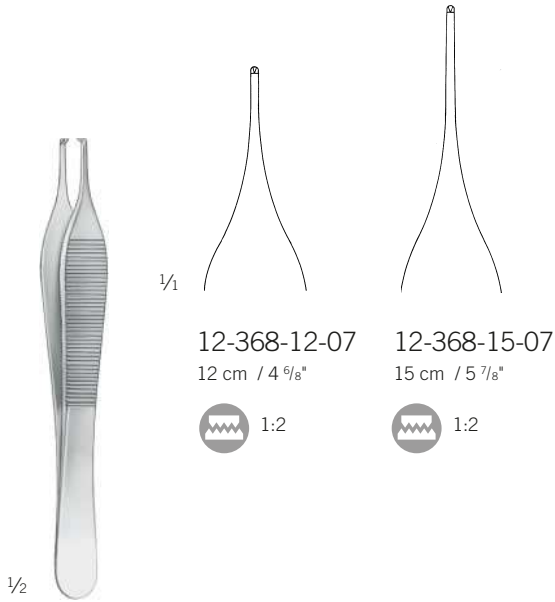

Adson  
12-368-12-07 -  
12-368-15-07

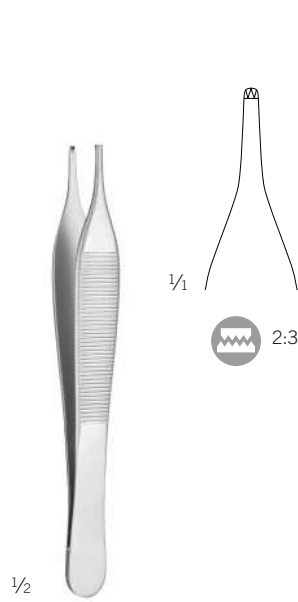

Adson  
12-369-12-07  
12 cm / 4 9/16"

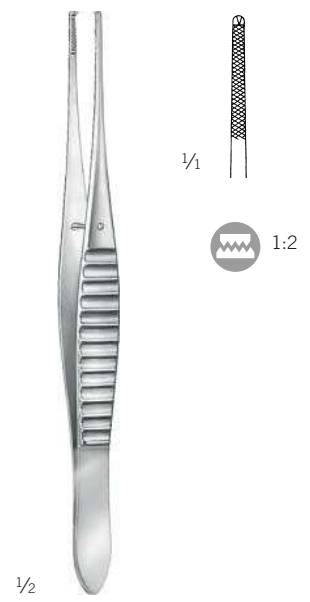

Gillies  
12-370-15-07  
15,5 cm / 6 1/8"

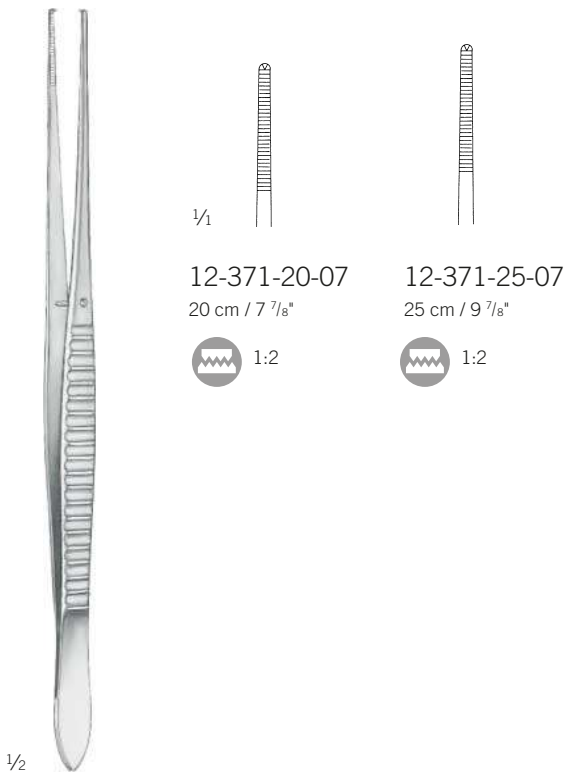

Waugh  
12-371-20-07 -  
12-371-25-07



Semken  
12-372-12-07 -  
12-372-15-07

## Chirurgische Pinzetten, Mikropinzetten

Tissue Forceps, Micro Forceps

Pinzas de disección con diente, Micro Pinzas

Pinces à dissection à griffes, Micro-Pinces

Pinze per dissezione con denti, Micro-Pinze

## Pinzetten

Forceps

Pinzas

Pinces

Pinze

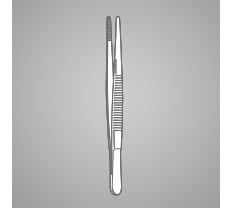

Taylor  
12-374-17-07  
17,5 cm / 6 7/8"



Taylor  
12-380-17-07  
17 cm / 6 5/8"  
mit Schaberende  
with dissector end  
con rascador  
à rugine  
con estremita a forma di raschino



Taylor  
12-383-17-07  
18,5 cm / 7 2/8"  
mit Schaberende  
with dissector end  
con rascador  
à rugine  
con estremita a forma di raschino

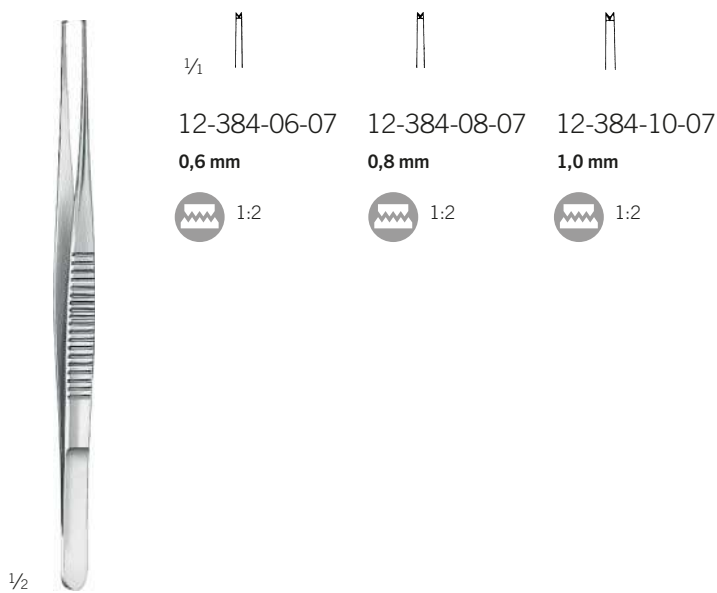

12-384-06-07  
0,6 mm

12-384-08-07  
0,8 mm

12-384-10-07  
1,0 mm

12-384-06-07 -  
12-384-10-07  
15,5 cm / 6 1/8"

12

## Chirurgische Pinzetten

Tissue Forceps

Pinzas de disección con diente

Pinces à dissection à griffes

Pinze per dissezione con denti



1/2

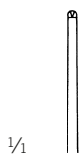

1/1

12-386-17-07

17,5 cm / 6 7/8"



1:2



12-387-17-07

17 cm / 6 5/8"



1:2

Gerald  
12-386-17-07 -  
12-387-17-07



1/2



1/1



1:2

Cushing  
12-388-17-07  
18 cm / 7 1/8"



1/2

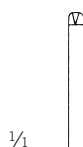

1/1

12-392-18-07

18 cm / 7 1/8"



1:2



12-392-21-07

21 cm / 8 2/8"



1:2



12-392-25-07

25 cm / 9 7/8"



1:2

Potts-Smith  
12-392-18-07 -  
12-392-25-07



1/2

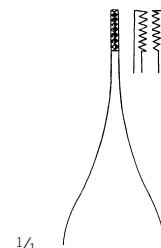

1/1



7:7

Adson-Brown  
12-400-12-07  
12 cm / 4 5/8"

## Anatomische Pinzetten, Chirurgische Pinzetten

Dissecting Forceps, Tissue Forceps

Pinzas de disección, Pinzas de disección con dientes

Pinces à dissection, Pinces à dissection à griffes

Pinze per dissezione, Pinze per dissezione con denti

## Pinzetten

Forceps

Pinzas

Pinces

Pinze

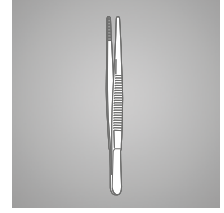

12

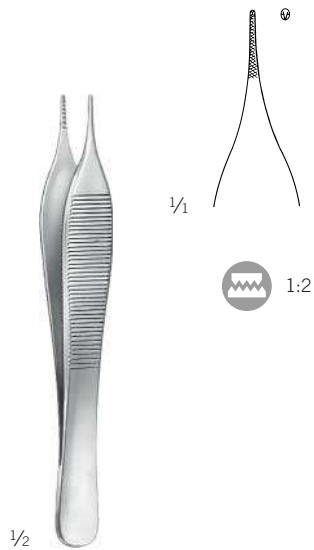

Mini-Adson  
12-402-12-07  
12 cm / 4 5/8"

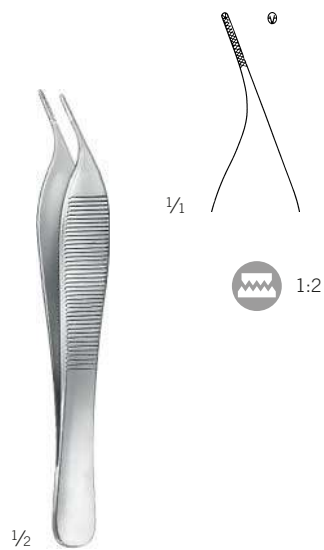

Mini-Adson  
12-403-12-07  
12 cm / 4 5/8"

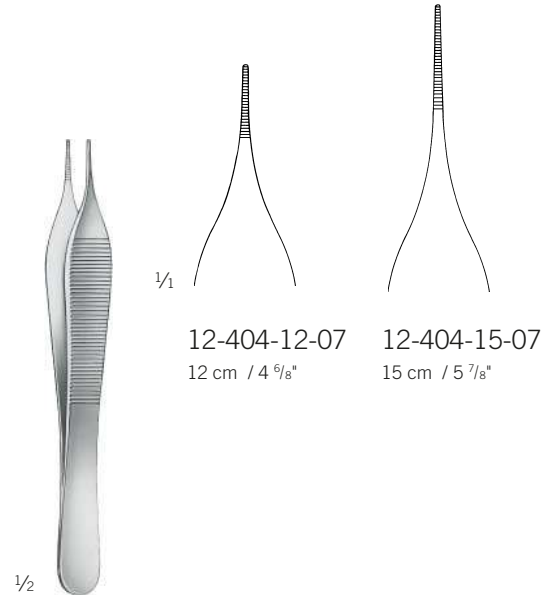

12-404-12-07  
12 cm / 4 5/8"

12-404-15-07  
15 cm / 5 7/8"

Mikro-Adson  
12-404-12-07 -  
12-404-15-07

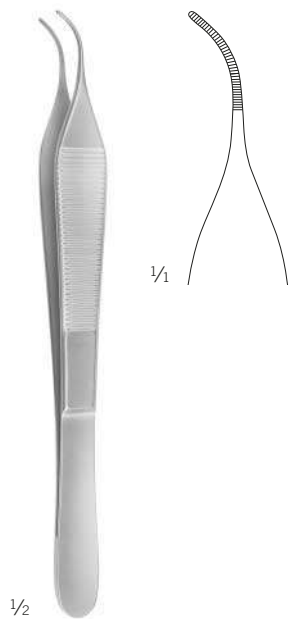

Mikro-Adson  
Shigeno  
12-405-15-07  
15 cm / 5 7/8"

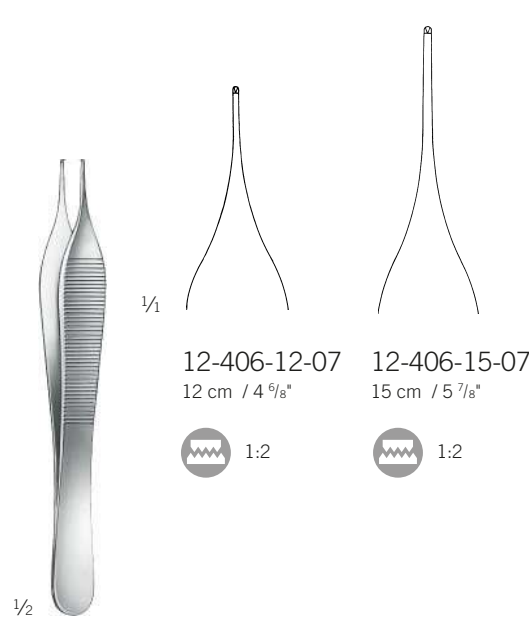

12-406-12-07  
12 cm / 4 5/8"

12-406-15-07  
15 cm / 5 7/8"

1:2

1:2

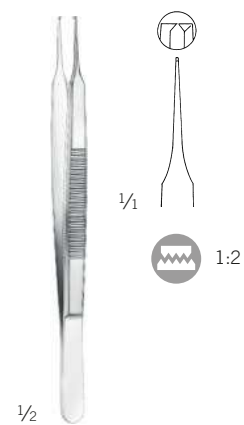

12-408-11-07  
10,5 cm / 4 1/8"  
sehr feine Zähne  
very fine teeth  
dientes muy finos  
dents très fines  
denti molto fini

# Uhrmacher-Pinzetten

Jeweler Type Forceps

Pinzas de relojero

Pinces d'horloger

Pinze da orologiaio

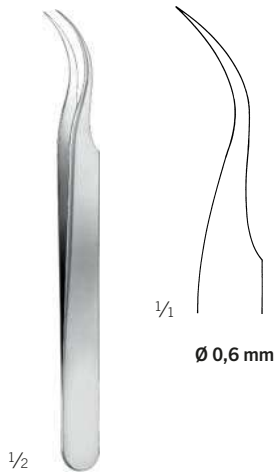

12-409-12-07

12 cm / 4 5/8"

Fig. 7

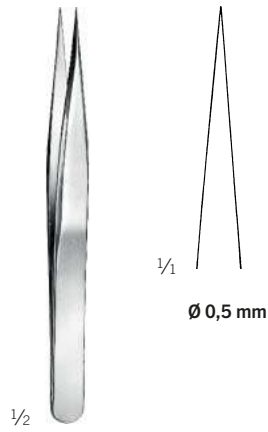

12-410-12-07

12 cm / 4 5/8"

Fig. 3

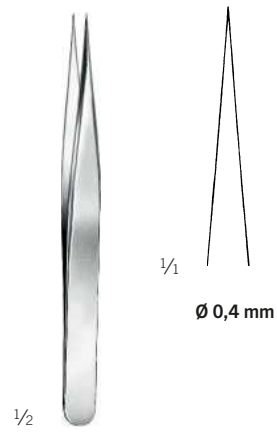

12-412-11-07

11 cm / 4 3/8"

Fig. 3 C

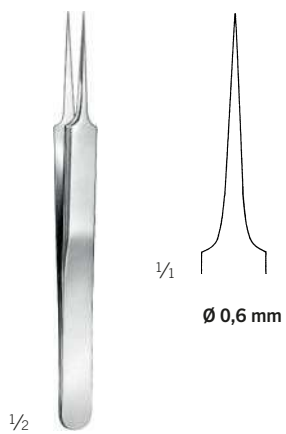

12-414-11-07

11 cm / 4 3/8"

Fig. 5

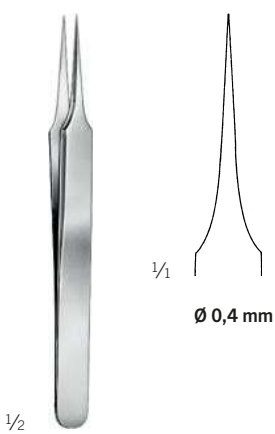

12-416-11-07

11 cm / 4 3/8"

Fig. 4

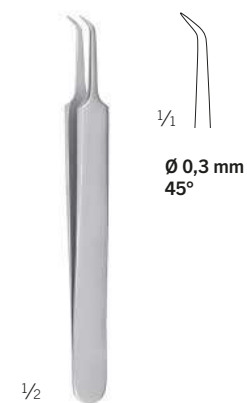

12-418-11-07

11 cm / 4 3/8"

## Chirurgische Pinzetten

Tissue Forceps  
 Pinzas de disección con diente  
 Pincers à dissection à griffes  
 Pinze per dissezione con denti

## Pinzetten

Forceps  
 Pinzas  
 Pincers  
 Pinze

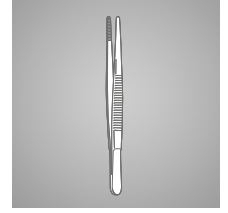

1/2

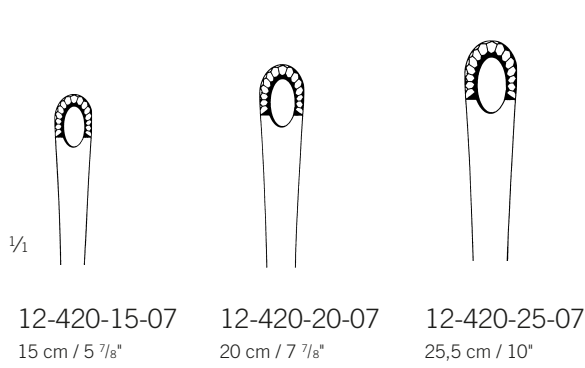

12-420-15-07  
 15 cm / 5 7/8"

12-420-20-07  
 20 cm / 7 7/8"

12-420-25-07  
 25,5 cm / 10"

Russ. Modell  
 12-420-15-07 -  
 12-420-25-07



1/2

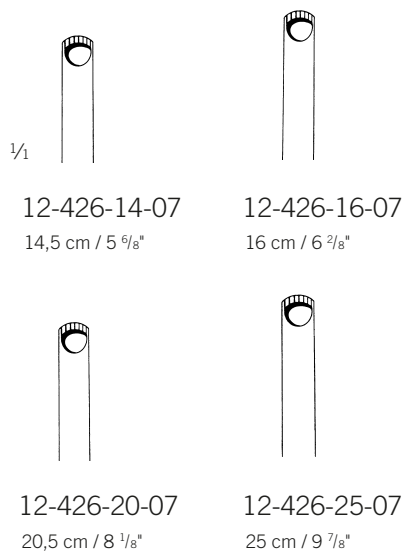

12-426-14-07  
 14,5 cm / 5 6/8"

12-426-16-07  
 16 cm / 6 2/8"

12-426-20-07  
 20,5 cm / 8 1/8"

12-426-25-07  
 25 cm / 9 7/8"

Durante  
 12-426-14-07 -  
 12-426-25-07



1/2



1/1

12-444-18-07  
 18 cm / 7 1/8"



3:4

Stille-Barraya  
 12-444-18-07

12

## Chirurgische Pinzetten, Anatomische Pinzetten

Tissue Forceps, Dissecting Forceps

Pinzas de disección con diente, Pinzas de disección

Pinces à dissection à griffes, Pinces à dissection

Pinze per dissezione con denti, Pinze per dissezione

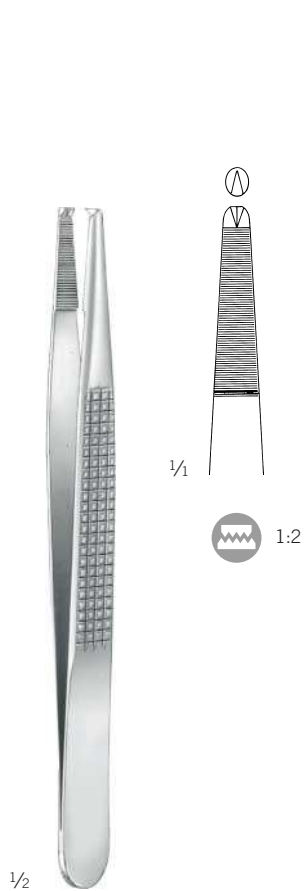

Bonney  
12-451-18-07  
17,5 cm / 6 7/8"



Mayo  
12-456-23-07  
23 cm / 9"



Singley-Tuttle  
12-460-18-07  
18 cm / 7 1/8"



Singley-Tuttle  
12-460-23-07  
23 cm / 9"

## Chirurgische Pinzetten

Tissue Forceps

Pinzas de disección con diente

Pinces à dissection à griffes

Pinze per dissezione con denti

## Pinzetten

Forceps

Pinzas

Pinces

Pinze

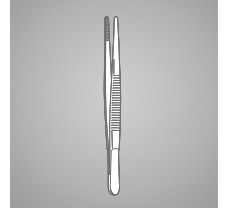

12



Nelson  
12-466-23-07  
23 cm / 9"



Resano  
12-467-23-07  
23 cm / 9"

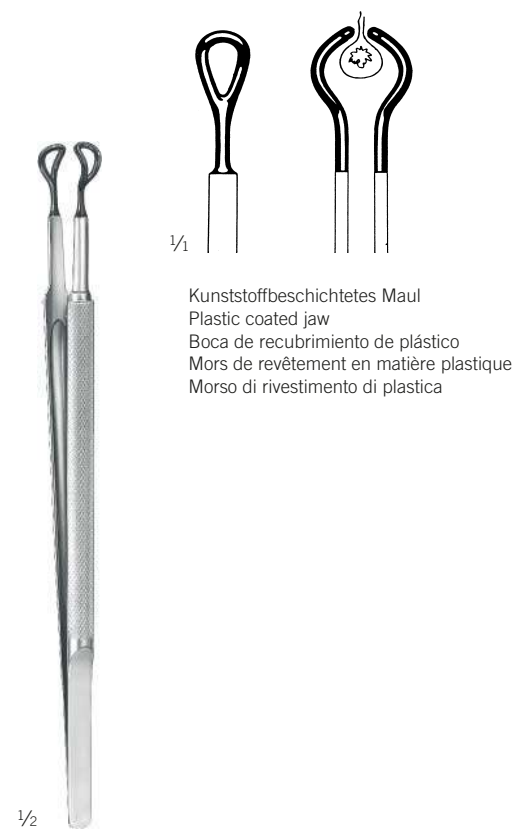

Hepp-Scheidel  
12-468-18-07  
18 cm / 7 1/8"  
Tubenfasspinzette  
Tubal forceps  
Pinza para tubos  
Pince pour saisir les trompes  
pinza oer afferare tubi

## Anatomische Pinzetten, Chirurgische Pinzetten

Dissecting Forceps, Tissue Forceps

Pinzas de disección, Pinzas de disección con dientes

Pinces à dissection, Pinces à dissection à griffes

Pinze per dissezione, Pinze per dissezione con denti



12-502-10-07  
10 cm / 3 7/8"



12-503-10-07  
10 cm / 3 7/8"



12-505-10-07  
9,5 cm / 3 7/8"



12-512-10-07  
10 cm / 3 7/8"



12-513-10-07  
10 cm / 3 7/8"



12-515-10-07  
9,5 cm / 3 7/8"



12-502-10-07 -  
12-515-10-07

fein  
delicate  
fino  
fin  
fino

## Kurze Mikropinzetten

Short Micro Forceps  
Micro Pinzas, corto  
Micro-Pinces, court  
Micro-Pinze, corto

## Pinzetten

Forceps  
Pinzas  
Pinces  
Pinze

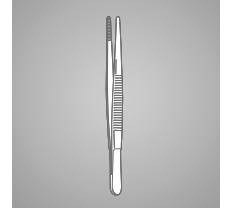

1/2

12-552-01-07 -  
12-553-06-07  
11 cm / 4 3/8"

1/1

Ø	0.15 mm	0.20 mm	0.30 mm
St	12-552-01-07	12-552-02-07	12-552-03-07

1/1

Ø	0.50 mm	1.2 mm	
St	12-553-01-07	12-553-05-07	12-553-06-07

1/1

	VD	VD	VD
Ø	0.10 mm	0.20 mm	0.30 mm
gewinkelt/angled/ acodada/angulée/ angolata	10°	10°	10°
St	12-552-04-07	12-552-05-07	12-552-06-07



1/2

12-552-07-07 -  
12-553-09-07  
11 cm / 4 3/8"

1/1

Ø	0.15 mm	0.20 mm	0.30 mm
St	12-552-07-07	12-552-08-07	12-552-09-07

1/1

Ø	0.50 mm	1.2 mm	
St	12-553-07-07	12-553-08-07	12-553-09-07

1/1

	VD	VD	VD
Ø	0.10 mm	0.20 mm	0.30 mm
gewinkelt/angled/ acodada/angulée/ angolata	10°	10°	10°
St	12-552-10-07	12-552-11-07	12-552-12-07

12

## Mikropinzetten, Gefäß-Dilatationspinzetten

Micro Forceps, Micro dilating forceps

Micro Pinzas, Micro pinza de dilatación

Micro-Pinces, Micro pince à dilater

Micro-Pinze, Micro pinze per dilatazione

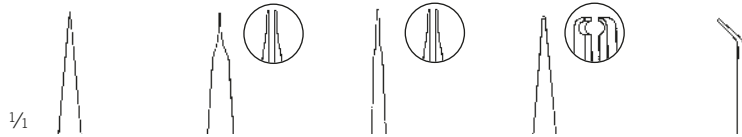

		VD	VD	Pierse	45°
11 cm / 4 3/8"	Ø	0.30 mm	0.20 mm	0.30 mm	0.30 mm
	St	12-560-00-07			12-560-05-07
13,5 cm / 5 3/8"	Ø				
	St	12-561-00-07	12-561-02-07	12-561-03-07	12-561-05-07

1/2

Jeweler mod.  
12-560-00-07 -  
12-561-45-07

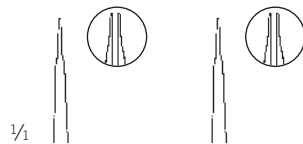

		VD	VD
11 cm / 4 3/8"	Ø	0.20 mm	0.30 mm
	gewinkelt/angled/ acodada/angulée/ angolata	10°	10°
	St	12-560-02-07	12-560-03-07

1/2

Jeweler mod.  
12-560-02-07 -  
12-560-03-07



				45°			Pierse
15 cm / 5 7/8"	Ø	0.30 mm	0.30 mm	0.30 mm	R Ø 1.0 x 0.5 mm	VD 0.30 mm	P 0.30 m
	St	12-562-00-07	12-562-01-07	12-562-02-07	12-562-03-07	12-562-04-07	12-562-05-07
18 cm / 7 1/8"	Ø						
	St	12-563-00-07	12-563-01-07	12-563-02-07	12-563-03-07	12-563-04-07	12-563-05-07

1/2

12-562-00-07 -  
12-563-05-07

# Mikropinzetten

Micro Forceps

Micro Pinzas

Micro-Pinces

Micro-Pinze



1/2



1/1



		1:2	1:2	1:2	1:2
15 cm / 5 7/8"	Ø	0.40 mm	0.40 mm	0.70 mm	0.70 mm
	St	12-568-15-07	12-569-15-07	12-570-15-07	12-571-15-07
	Ti	12-582-15-09	12-583-15-09		
18 cm / 7 1/8"	St	12-568-18-07	12-569-18-07	12-570-18-07	12-571-18-07
	Ti	12-582-18-09	12-583-18-09		

12-568-15-07 -  
12-583-18-09



1/2



1/1

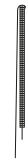

					Atrauma	
15 cm / 5 7/8"	Ø	1.0 x 0.5 mm	1.0 x 0.5 mm	2.0 x 1.0 mm	2.0 x 1.0 mm	1.2 mm
	St	12-574-15-07	12-774-15-07	12-576-15-07	12-776-15-07	12-589-15-07
	Ti	12-586-15-09	12-786-15-09	12-588-15-09	12-787-15-09	12-590-15-09
18 cm / 7 1/8"	St	12-574-18-07	12-774-18-07	12-576-18-07	12-776-18-07	12-589-18-07
	Ti	12-586-18-09	12-786-18-09	12-588-18-09	12-787-18-09	12-590-18-09
21 cm / 8 3/8"	St	12-574-21-07	12-774-21-07	12-576-21-07	12-776-21-07	12-589-21-07
	Ti	12-586-21-09	12-786-21-09	12-588-21-09	12-787-21-09	12-590-21-09

12-574-15-07 -  
12-590-21-09

## Mikropinzetten, Gefäß-Dilatationspinzetten

Micro Forceps, Micro dilating forceps

Micro Pinzas, Micro pinza de dilatación

Micro-Pinces, Micro pince à dilater

Micro-Pinze, Micro pinze per dilatazione



1/2

12-564-15-07 -  
12-581-21-09



diamond-coated

1/1



	Ø	0.40 mm	0.40 mm	0.70 mm	0.70 mm	0.80 mm	0.80 mm
15 cm / 5 7/8"	St	12-564-15-07	12-565-15-07	12-566-15-07	12-567-15-07		
	Ti	12-578-15-09	12-579-15-09			12-580-15-09	12-581-15-09
18 cm / 7 1/8"	St	12-564-18-07	12-565-18-07	12-566-18-07	12-567-18-07		
	Ti	12-578-18-09	12-579-18-09			12-580-18-09	12-581-18-09
21 cm / 8 2/8"	St			12-566-21-07	12-567-21-07		
	Ti					12-580-21-09	12-581-21-09



1/2

12-591-01-07 -  
12-592-05-07



diamond-coated

1/1



				45°		VD	Pierse
	Ø	0.30 mm	0.30 mm	0.30 mm	1.0 x 0.5 mm	0.30 mm	0.40 mm
15 cm / 5 7/8"	St	12-591-00-07	12-591-01-07	12-591-02-07	12-591-03-07	12-591-04-07	12-591-05-07
18 cm / 7 1/8"	St	12-592-00-07	12-592-01-07	12-592-02-07	12-592-03-07	12-592-04-07	12-592-05-07

## Splitterpinzetten

Splinter Forceps  
Pinzas para espinas  
Pincas à échardes  
Pinze per scheggie

## Pinzetten

Forceps  
Pinzas  
Pincas  
Pinze



12

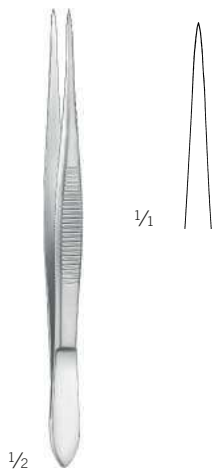

12-600-12-07

12,5 cm / 4 7/8"  
glattes Maul  
smooth jaw  
boca lisa  
mors lisse  
morso liscio

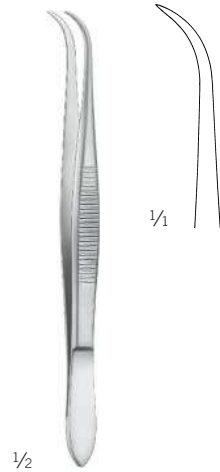

12-601-12-07

12,5 cm / 4 7/8"  
glattes Maul  
smooth jaw  
boca lisa  
mors lisse  
morso liscio

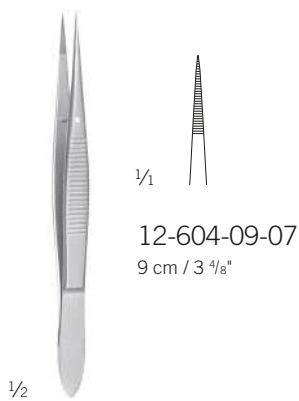

12-604-09-07  
9 cm / 3 4/8"



12-604-11-07  
10,5 cm / 4 1/8"



12-604-12-07  
12,5 cm / 4 7/8"

12-604-09-07 -  
12-604-12-07

gerieftes Maul  
serrated jaw  
boca estriada  
mors strié  
morso striato

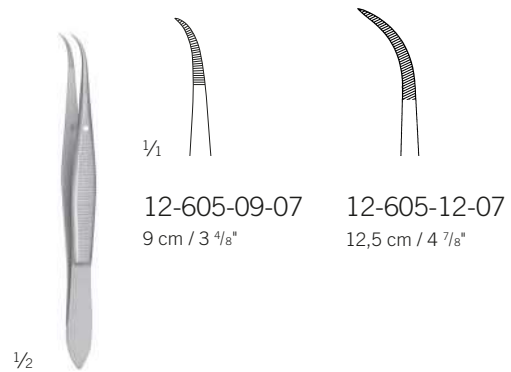

12-605-09-07  
9 cm / 3 4/8"

12-605-12-07  
12,5 cm / 4 7/8"

12-605-09-07 -  
12-605-12-07

gerieftes Maul  
serrated jaw  
boca estriada  
mors strié  
morso striato

## Splitterpinzetten

Splinter Forceps

Pinzas para espinas

Pinces à échardes

Pinze per scheggie



12-624-12-07  
12 cm / 5 <sup>9</sup>/<sub>8</sub>"

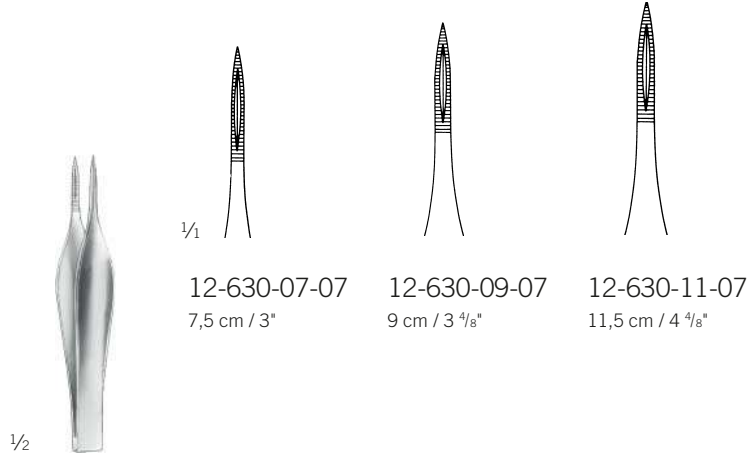

Feilchenfeld  
12-630-07-07 -  
12-630-11-07

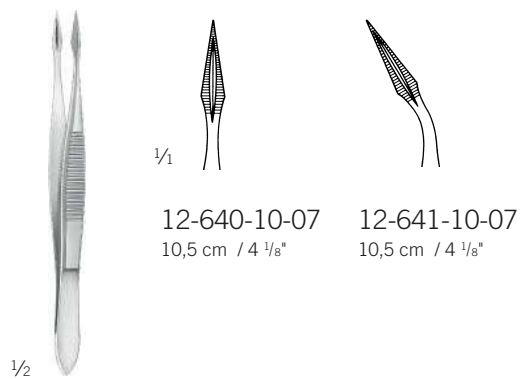

Hunter  
12-640-10-07 -  
12-641-10-07

## Cilienpinzetten

Cilia Forceps  
Pinzas depilatorias  
Pincas à épiler les cils  
Pinze depilatoria

## Pinzetten

Forceps  
Pinzas  
Pincas  
Pinze

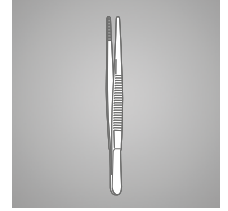

12

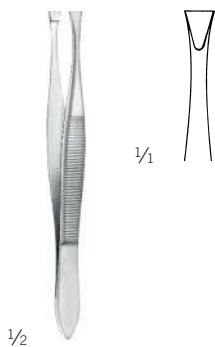

Littauer  
12-664-08-07

8,5 cm / 3 <sup>3</sup>/<sub>8</sub>"

glattes Maul  
smooth jaw  
boca lisa  
mors lisse  
morso liscio

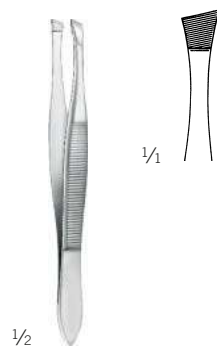

12-666-09-07

9 cm / 3 <sup>4</sup>/<sub>8</sub>"

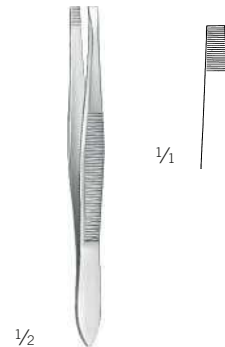

Douglas  
12-674-09-07

9 cm / 3 <sup>4</sup>/<sub>8</sub>"

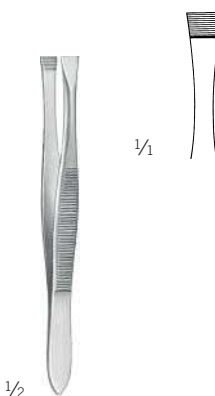

Douglas  
12-676-09-07

9 cm / 3 <sup>4</sup>/<sub>8</sub>"

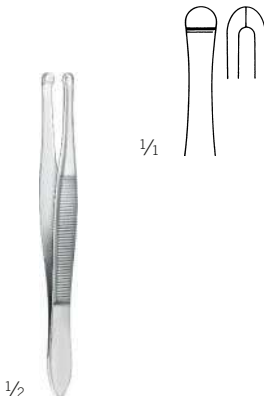

Beer  
12-680-09-07

9 cm / 3 <sup>4</sup>/<sub>8</sub>"

glattes Maul  
smooth jaw  
boca lisa  
mors lisse  
morso liscio

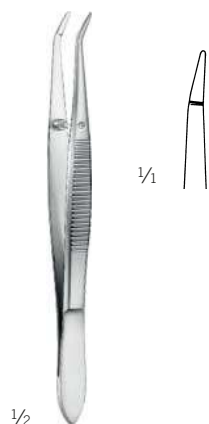

Barraquer  
12-695-10-07

11 cm / 4 <sup>3</sup>/<sub>8</sub>"

glattes Maul  
smooth jaw  
boca lisa  
mors lisse  
morso liscio

## Splitterzangen

Splinter Forceps  
Pinzas para espinas  
Pincers à échardes  
Pinze per scheggie

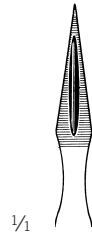

12-720-13-07  
14 cm / 5  $\frac{4}{8}$ "

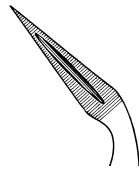

12-721-13-07  
13,5 cm / 5  $\frac{3}{8}$ "

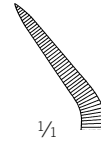
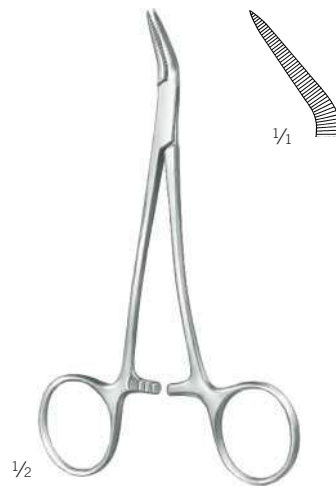

Peet  
12-725-11-07  
12,5 cm / 4  $\frac{7}{8}$ "

Stieglitz  
12-720-13-07 -  
12-721-13-07